

Multifunctional fireplace cabinet

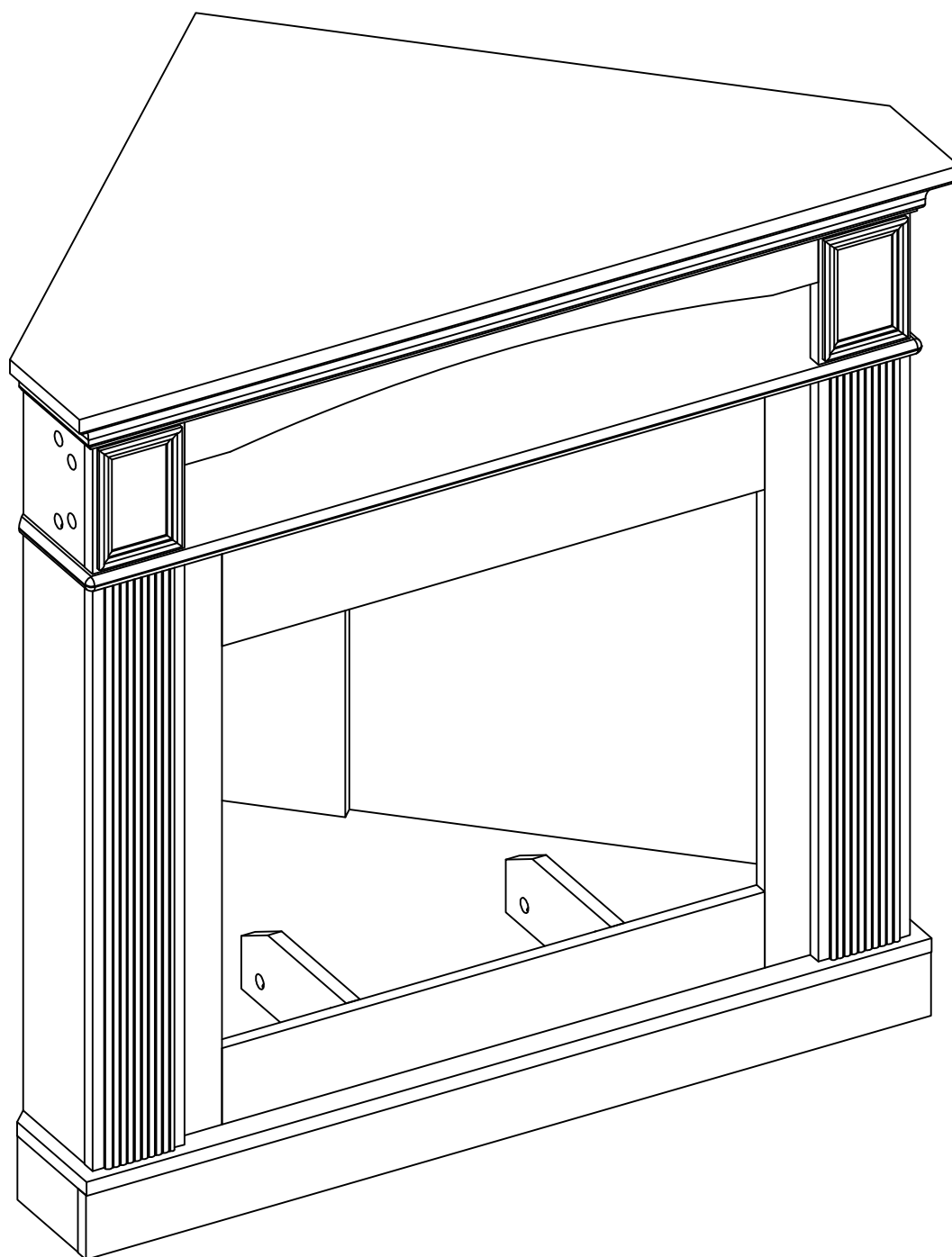

Parts List

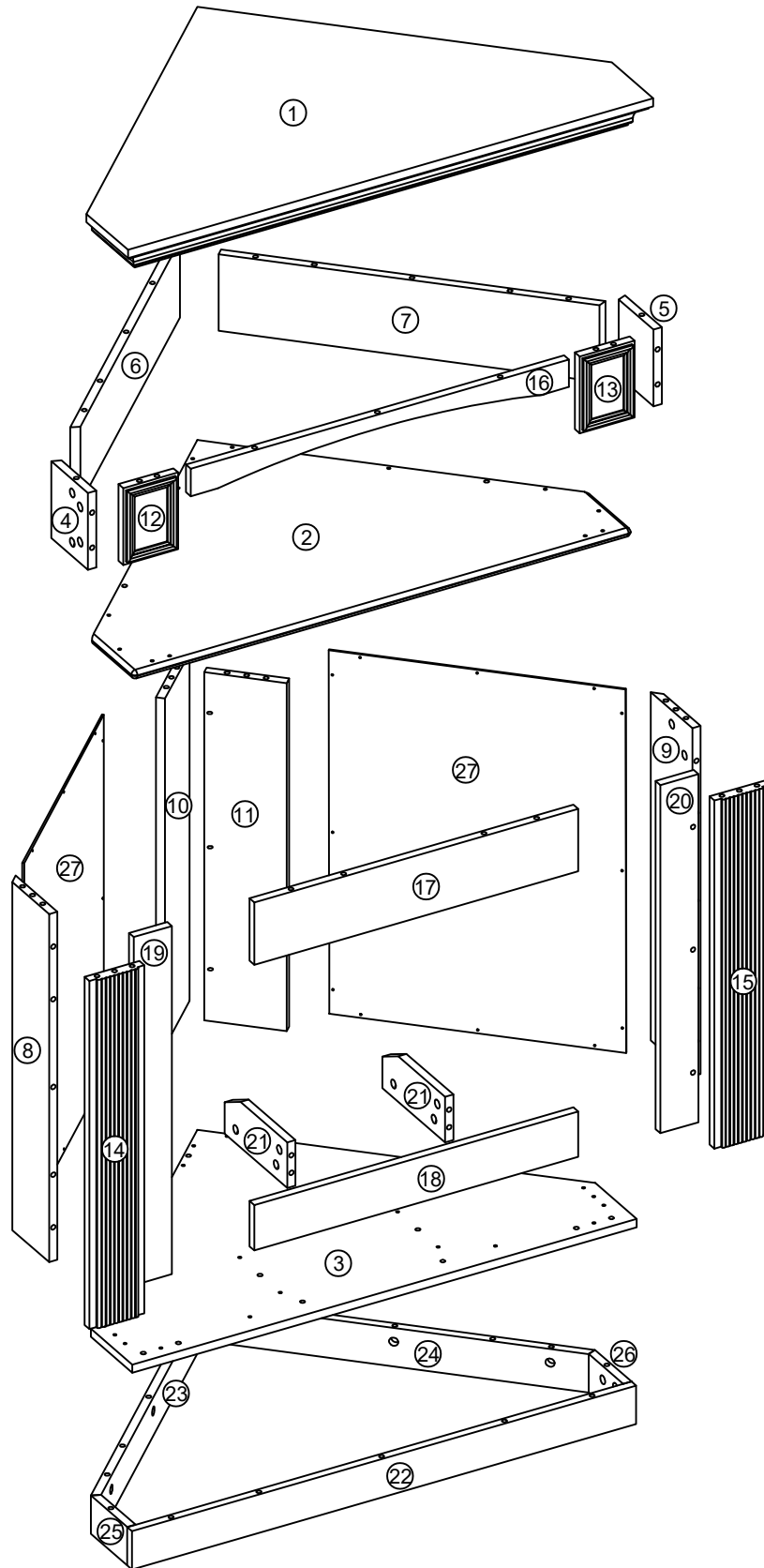

Hardware

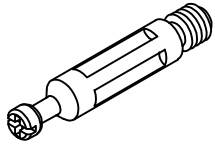

A x 82sets

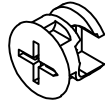

15X9.5MM

B x 82sets

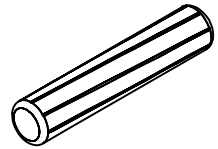

8 x 30MM

C x 48pcs

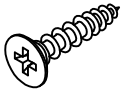

3.5 x 12MM

D x 14pcs

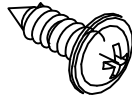

3.5 x 12MM

E x 26pcs

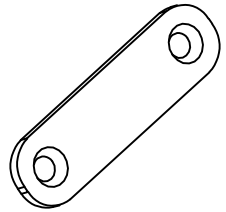

G x 6pcs

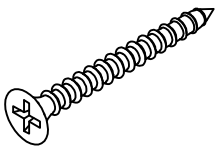

3.5 x 35MM

H x 7sets

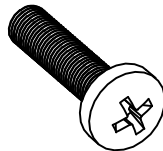





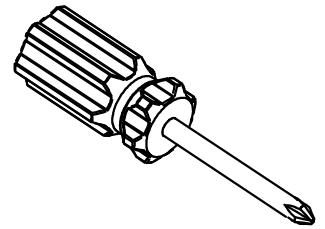



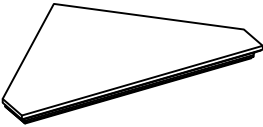

M6 x 25MM

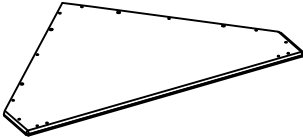
J x 7sets

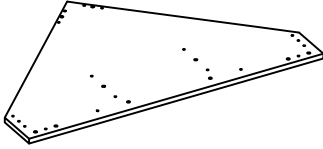

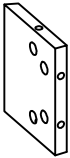

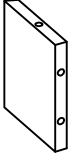
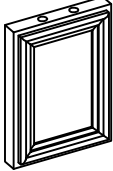
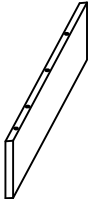
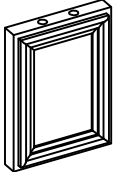
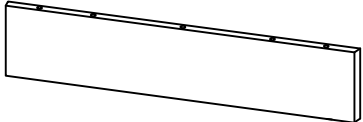

K x 1sets

ASSEMBLY MATERIAL

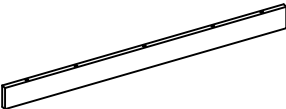
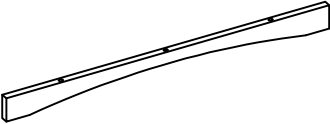
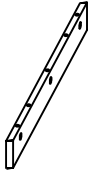
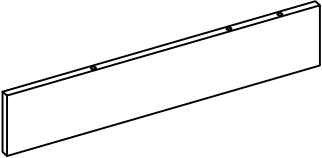
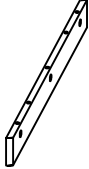
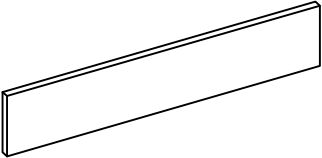
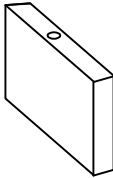
Item no.	Reference Image	Qty.	Item no.	Reference Image	Qty.
①		X1	⑧		X1
②		X1	⑨		X1
③		X1	⑩		X1
④		X1	⑪		X1
⑤		X1	⑫		X1
⑥		X1	⑬		X1
⑦		X1	⑭		X1

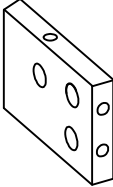
ASSEMBLY MATERIAL

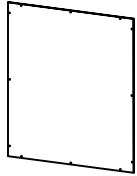
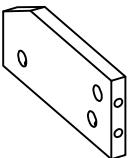
Item no.	Reference Image	Oty.	Item no.	Reference Image	Oty.
15		X1	22		X1
16		X1	23		X1
17		X1	24		X1
18		X1	25		X1
19		X1	26		X1
20		X1	27		X2
21		X2			

How to use the cam lock system

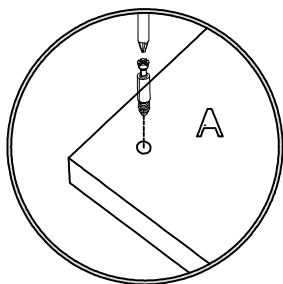

1. Screw cam bolt into panel

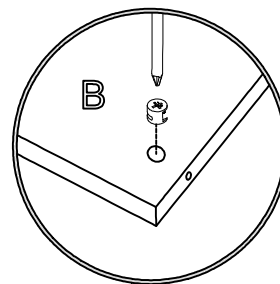

2. Push cam into panel - arrow feature on cam top points to panel edge

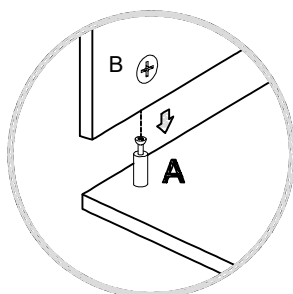

3. Align cam bolt(s) with cam(s) and insert all the way into cross-bored hole(s)

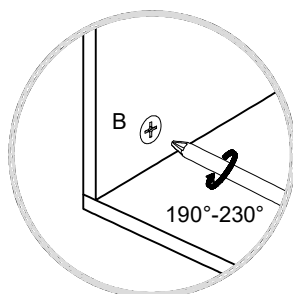

3. Rotate cam(s) clockwise 190°-230° to lock panels together

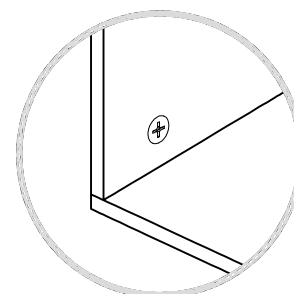

5. Panels should be tight against each other and connection should be rigid

Insert the wood dowel [C] at least half way by tapping lightly with a rubber mallet ,IF NECESSARY.

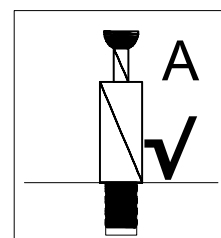
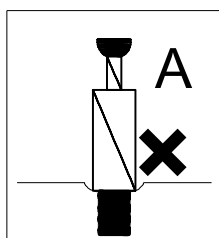
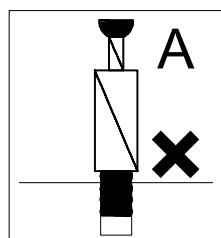
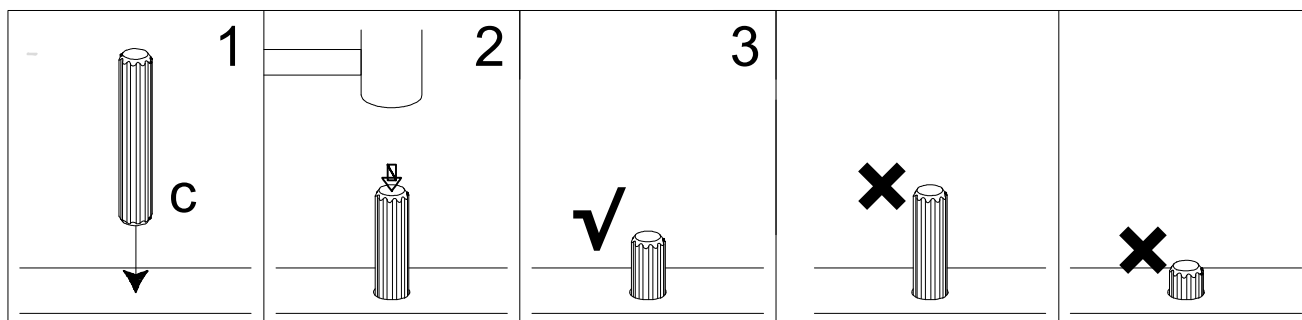

- Unit must be placed on a level surface or leveled with included hardware (when applicable).
- Do not sit or stand on or allow children to climb, sit or stand on the assembled product.
- For safety reasons, it is imperative that this unit be mounted to the wall.
- Do not use without installing the tip restraint.
- Unit can tip over causing severe injury or death.
- Do not exceed the recommended weight limits.
- Evenly distribute the weight on each level and always keep the heavier loads on the bottom.
- Before cutting, drilling or hammering into any wall or floor surface, verify the location of electrical, plumbing and gas lines. Cutting may cause serious injury.

Step 1

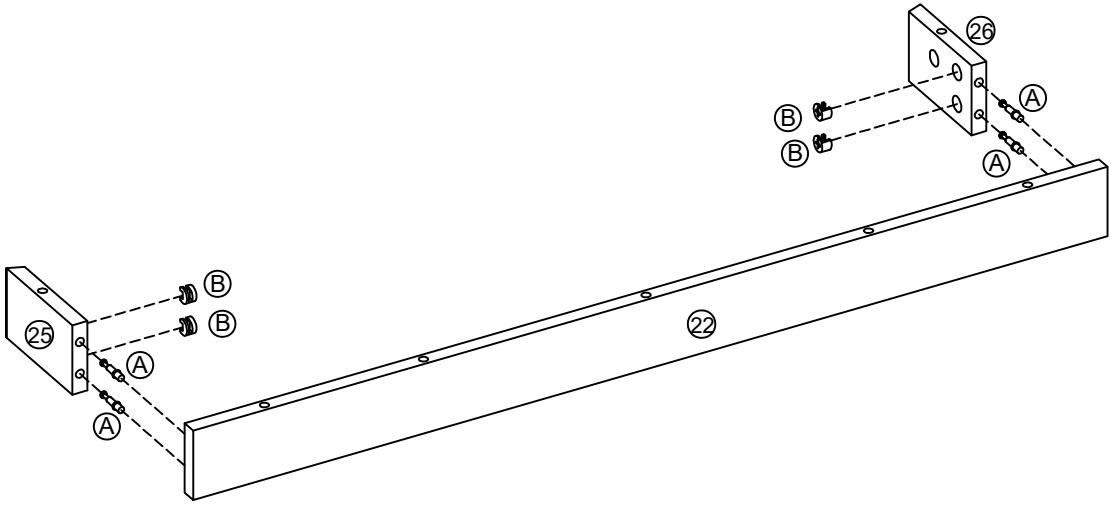
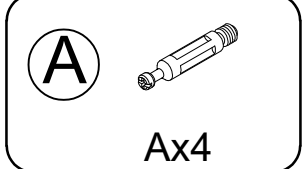
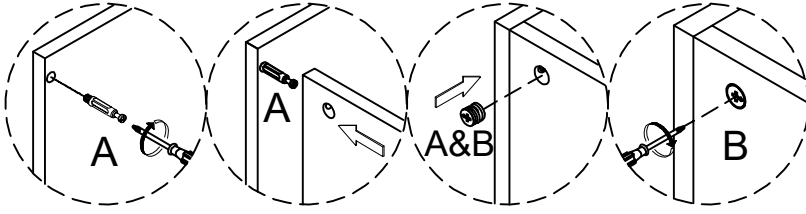

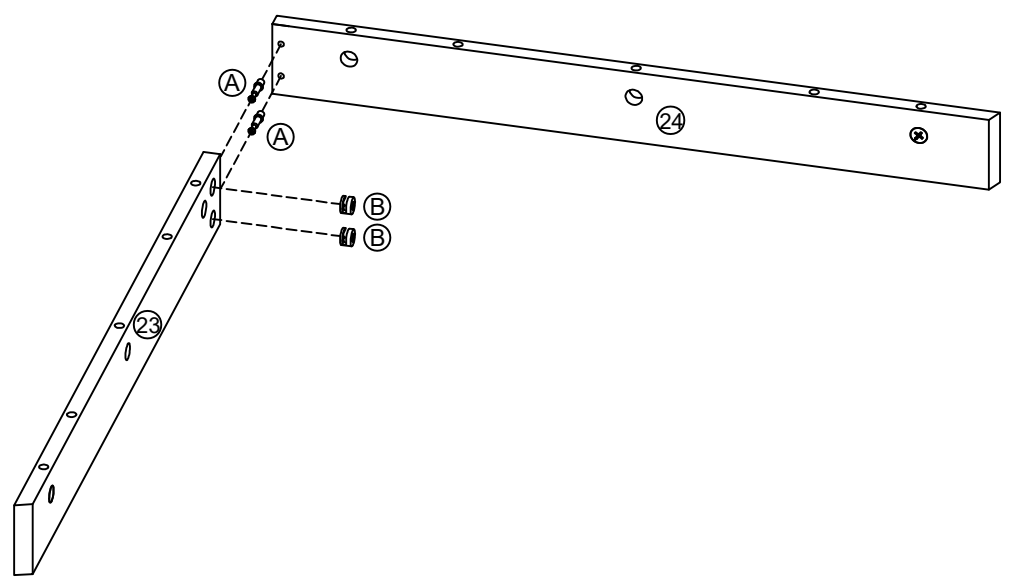
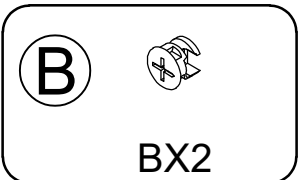
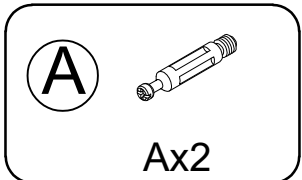
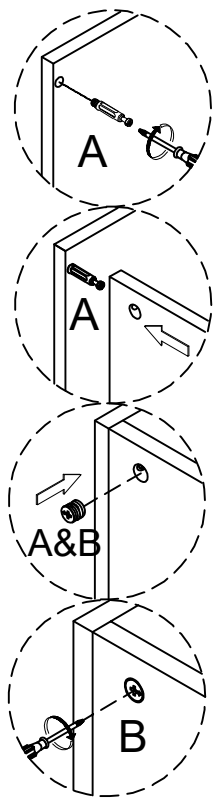

Step 2

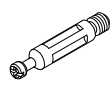

Step 3

A  Ax5

B  BX5

C  8 x 30MM
C x 2

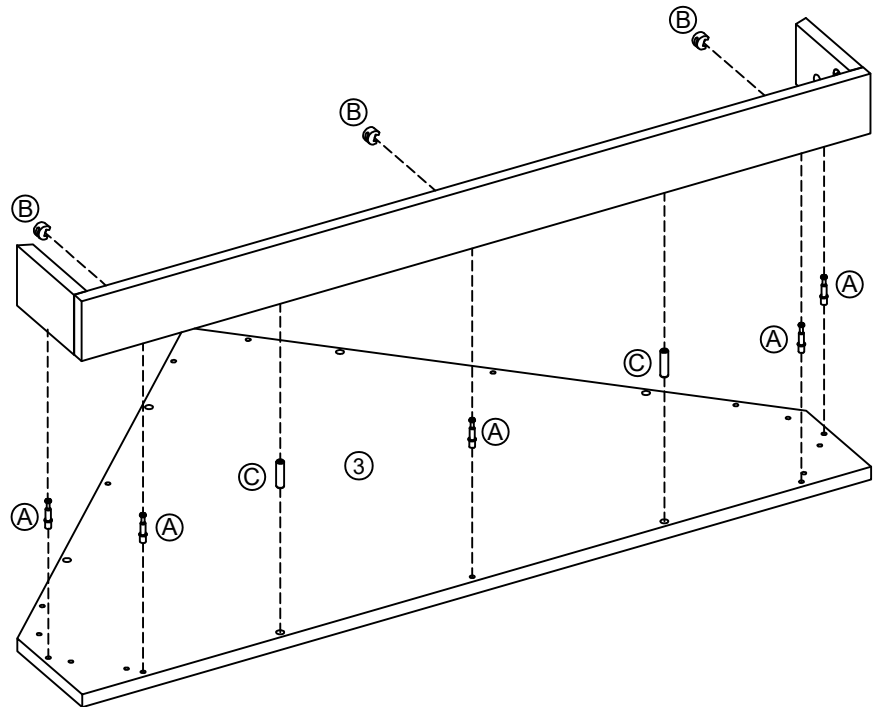
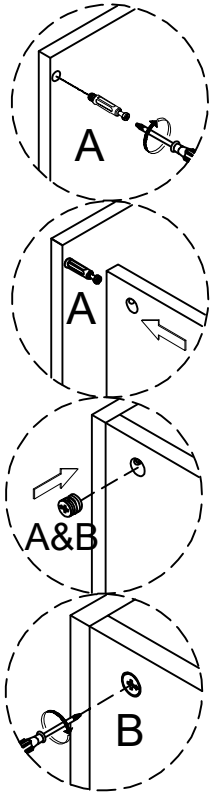

Step 4

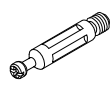
A  Ax6

B  BX6

C  8 x 30MM
C x 4

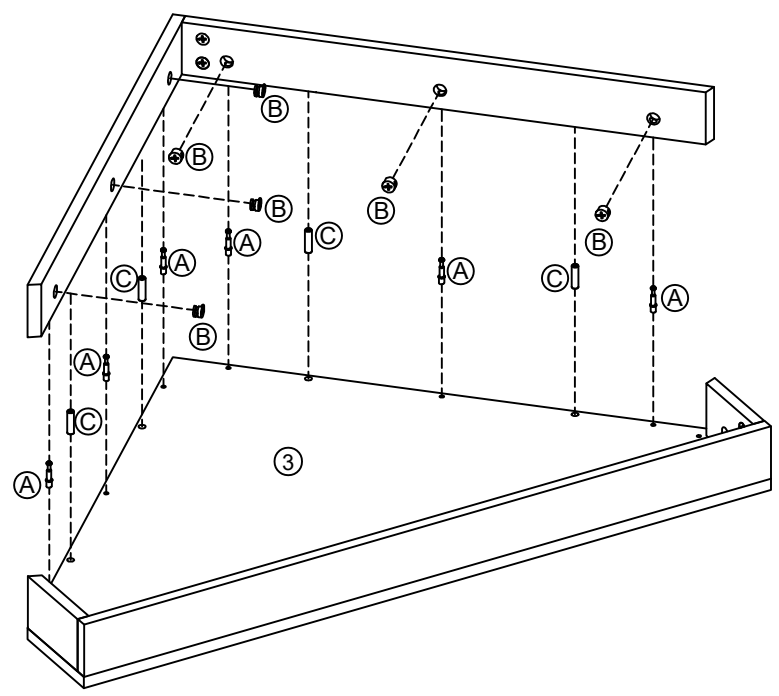
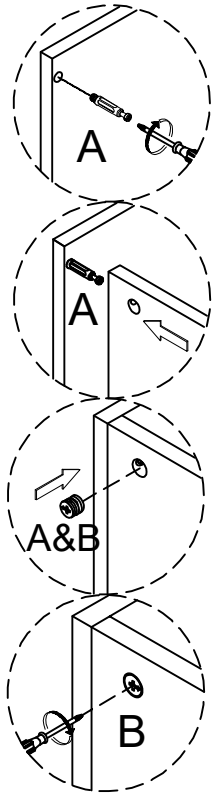

Step 5

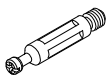
A  Ax2

B  BX2

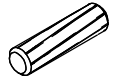
C  8 x 30MM
Cx2

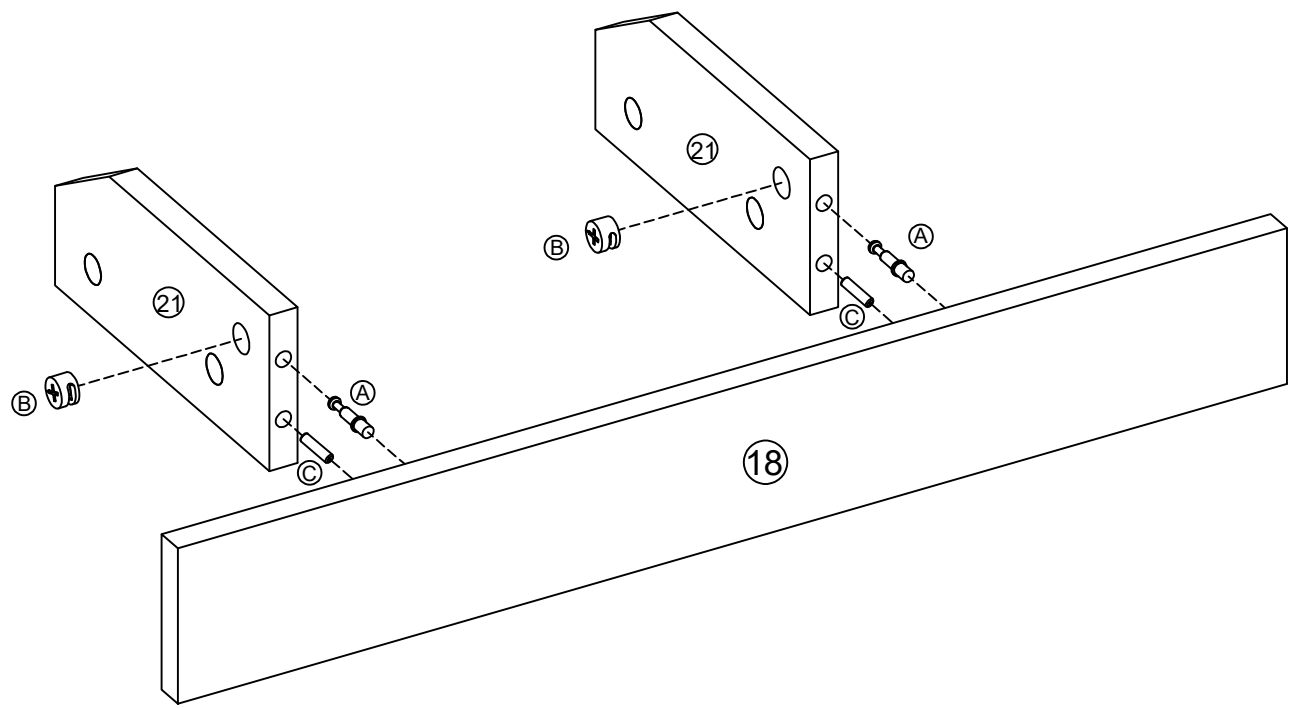

Step 6

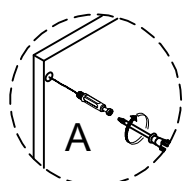

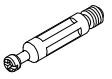
A  Ax3

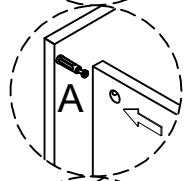

B  BX3

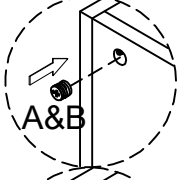

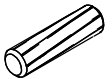
C  8 x 30MM
Cx2

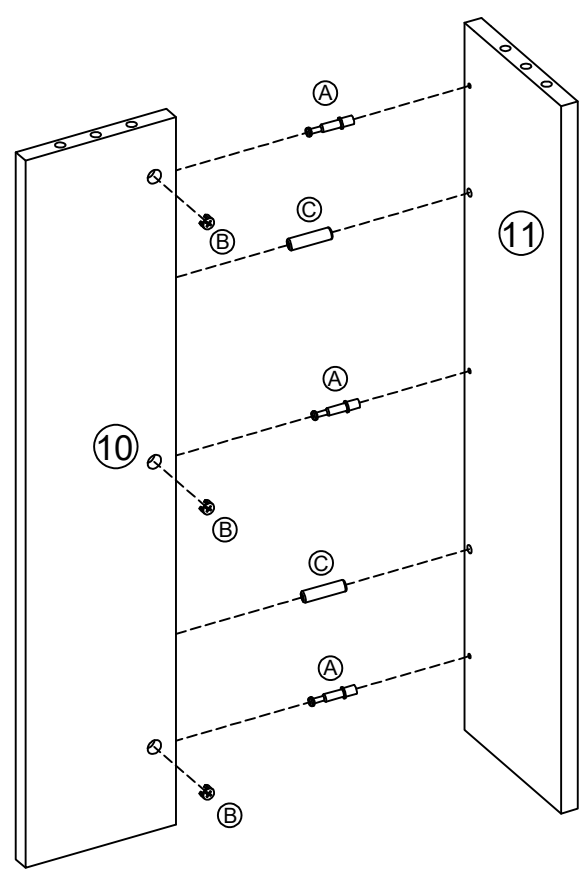
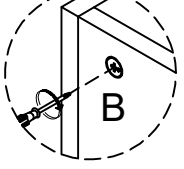

Step 7

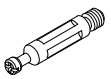
A  Ax6

B  BX6

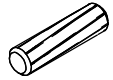
C  8 x 30MM
Cx4

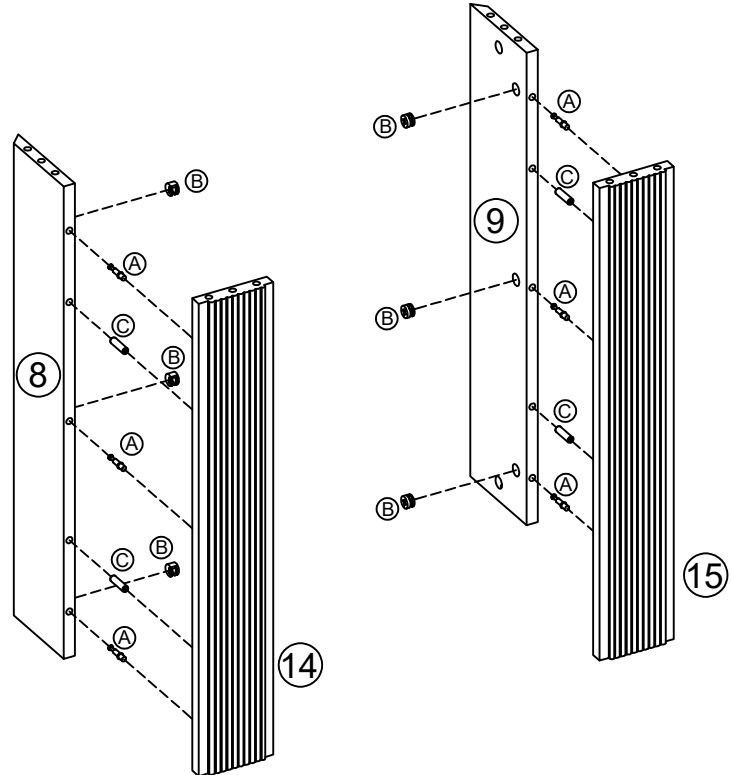
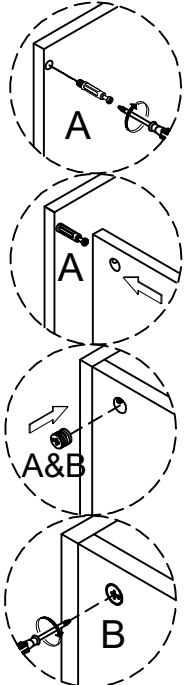

Step 8

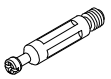
A  Ax6

B  BX6

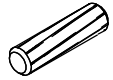
C  8 x 30MM
Cx4

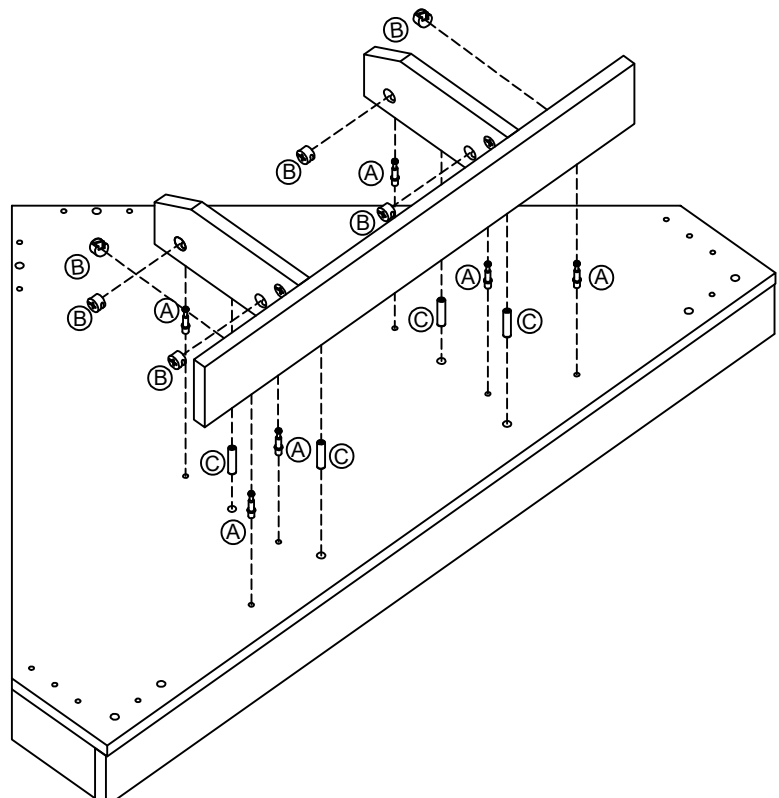
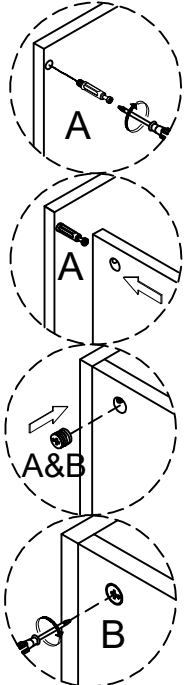

Step 9

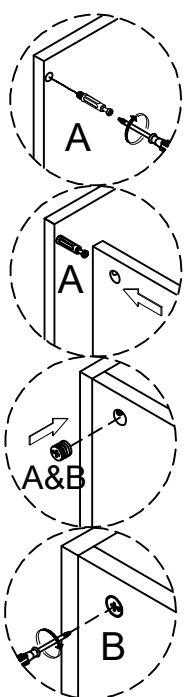

(B)  BX2

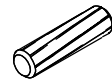
(C)  8 x 30MM
C x 6

(H)  3.5 x 35MM
H x 6

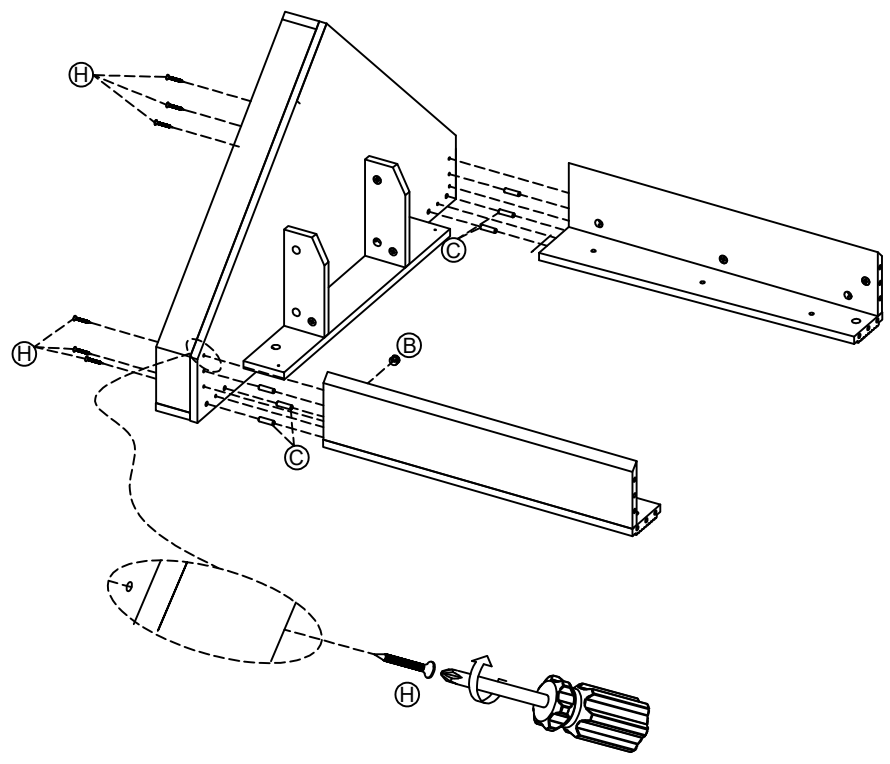

Step 10

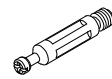
(A)  Ax4

(B)  BX4

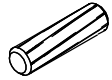
(C)  8 x 30MM
C x 2

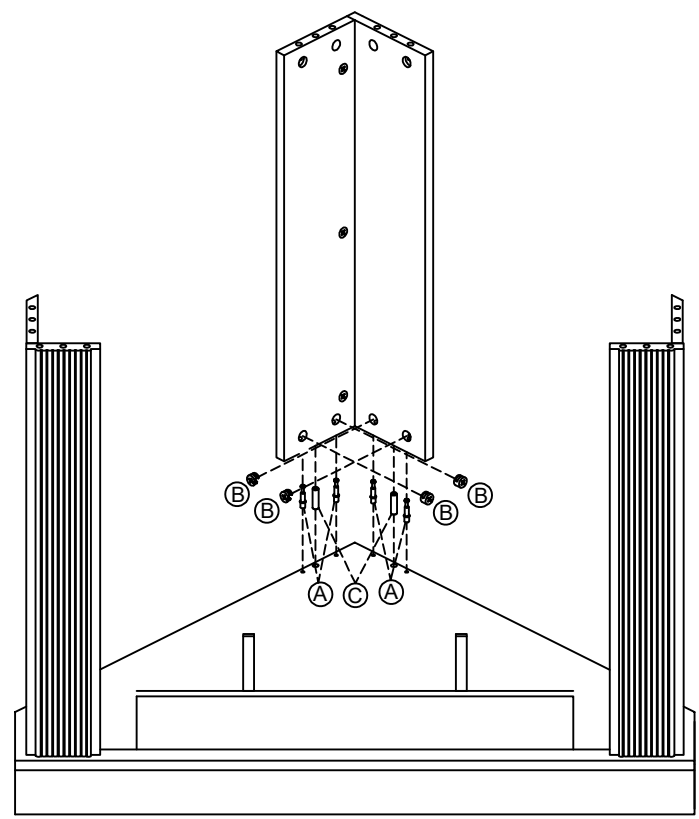
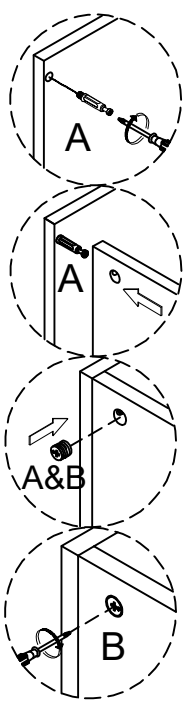

Step 11

A

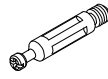

Ax2

B



Bx2

C



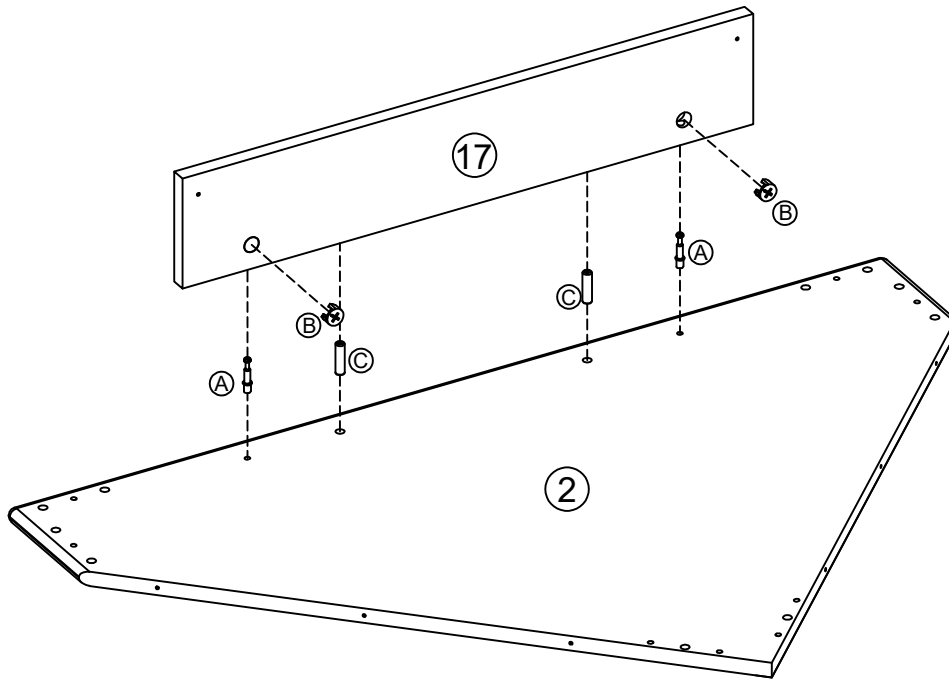
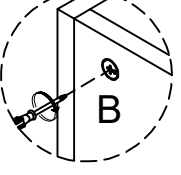
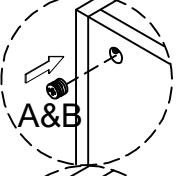
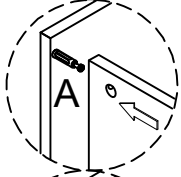
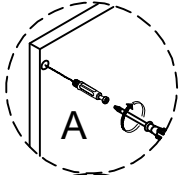

8 x 30MM

C x 2

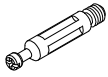

Step 12

A 
Ax8

B 
Bx8

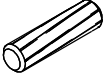
C 
8 x 30MM
Cx10

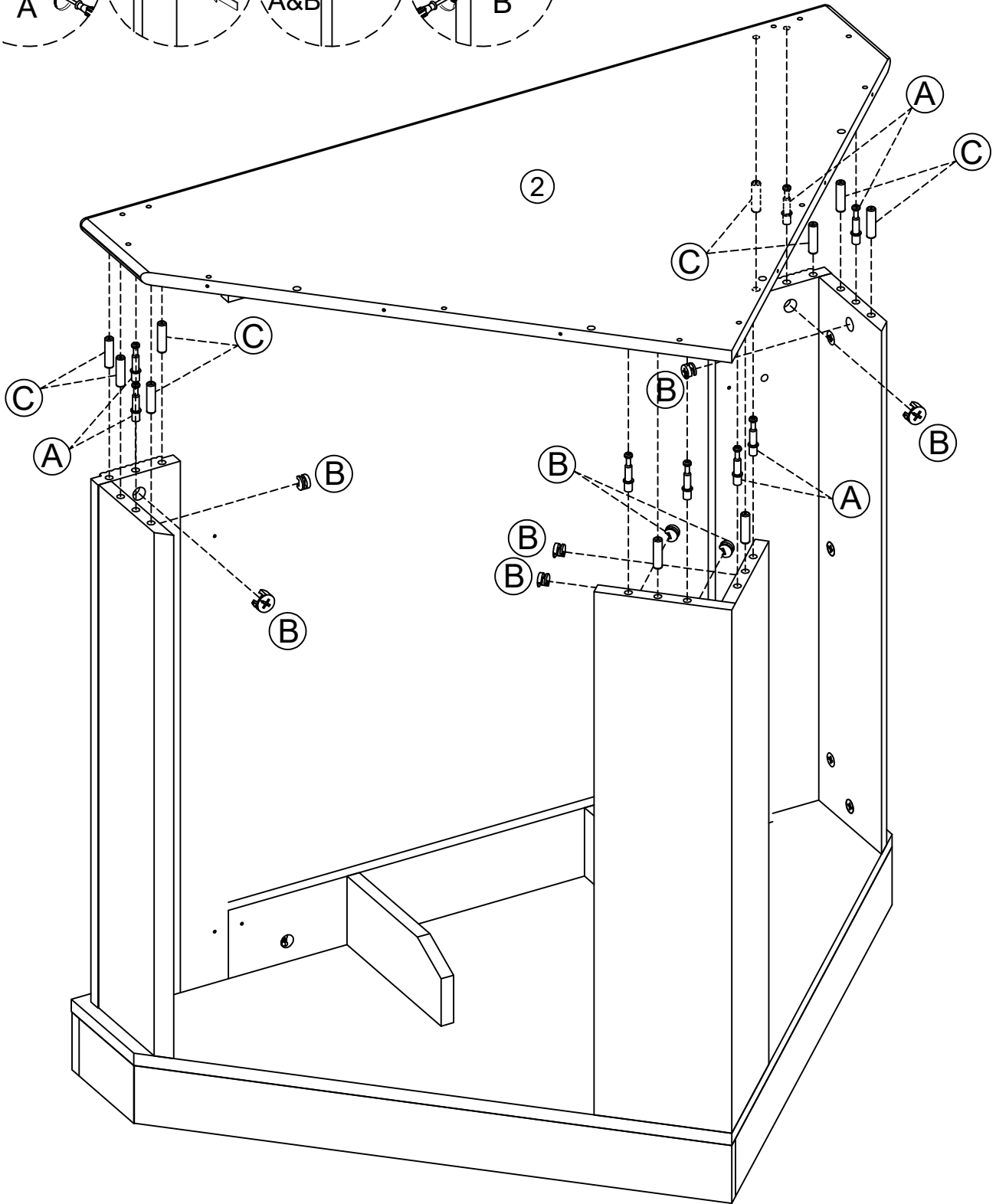
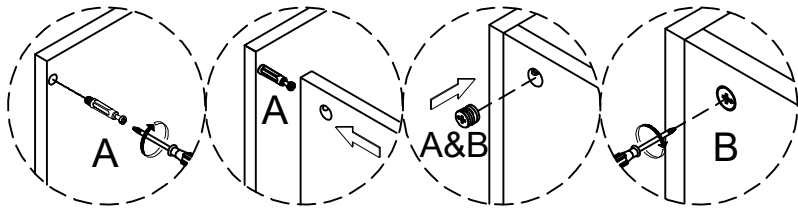

Step 13

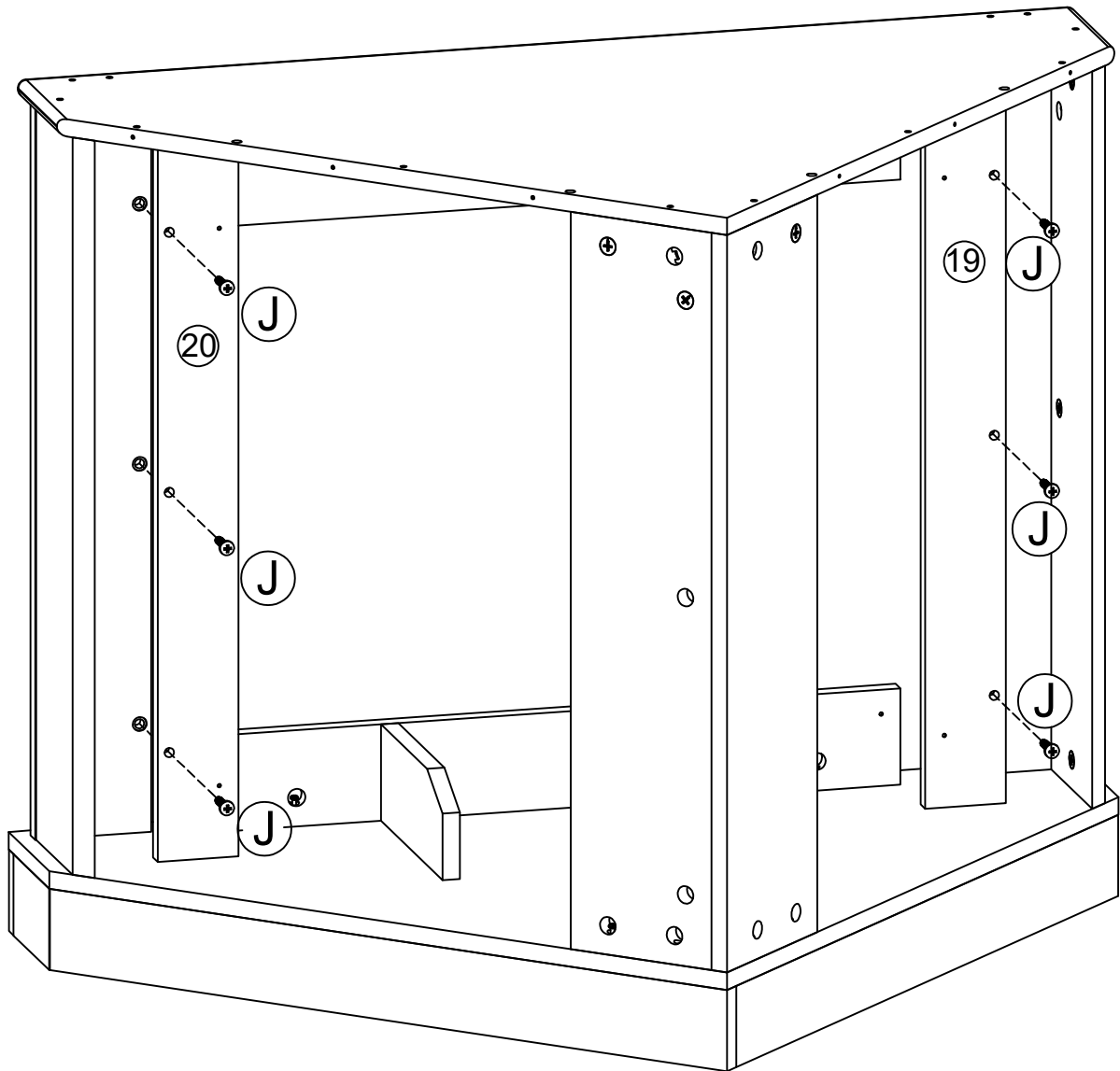
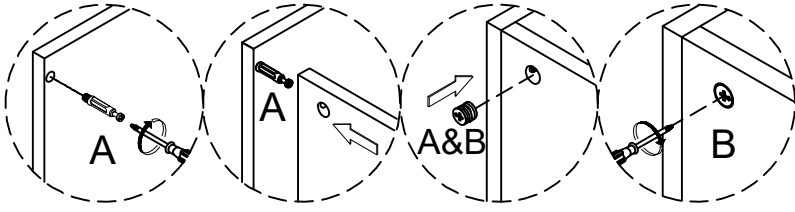
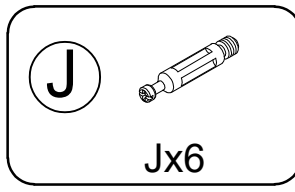

Step 14

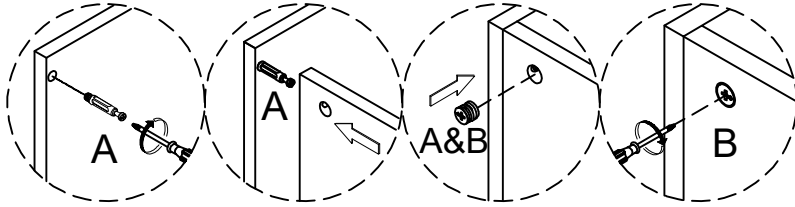

A

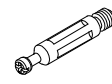

Ax2

B



Bx2

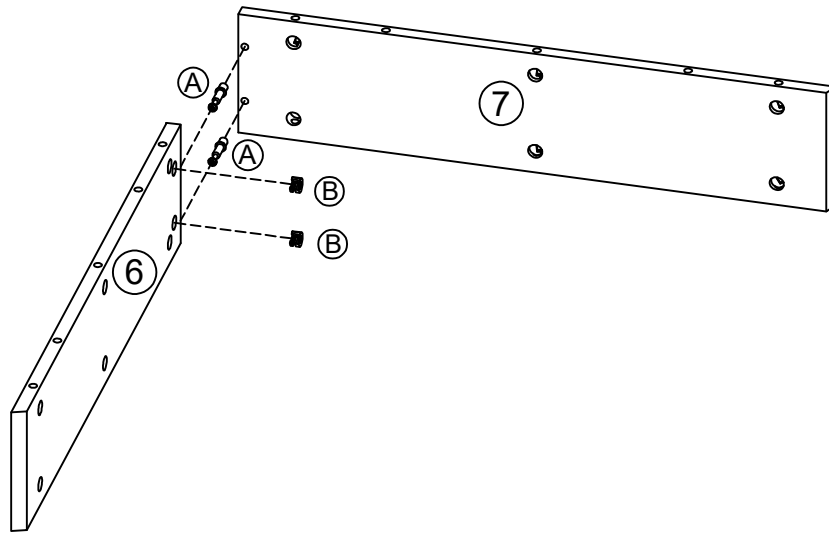

Step 15

A

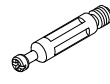

Ax4

B



Bx4

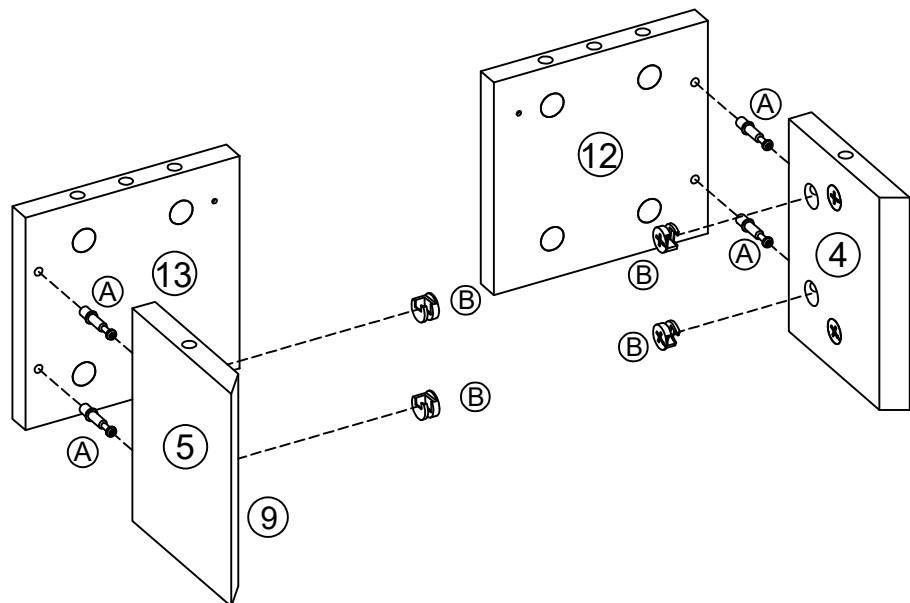
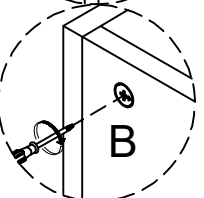
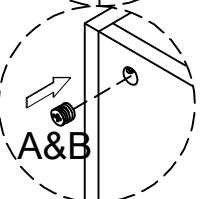
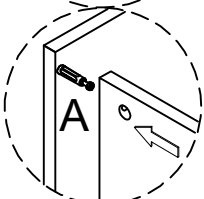
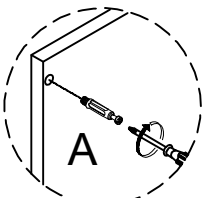

Step 16

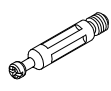
A 
Ax6

B 
BX6

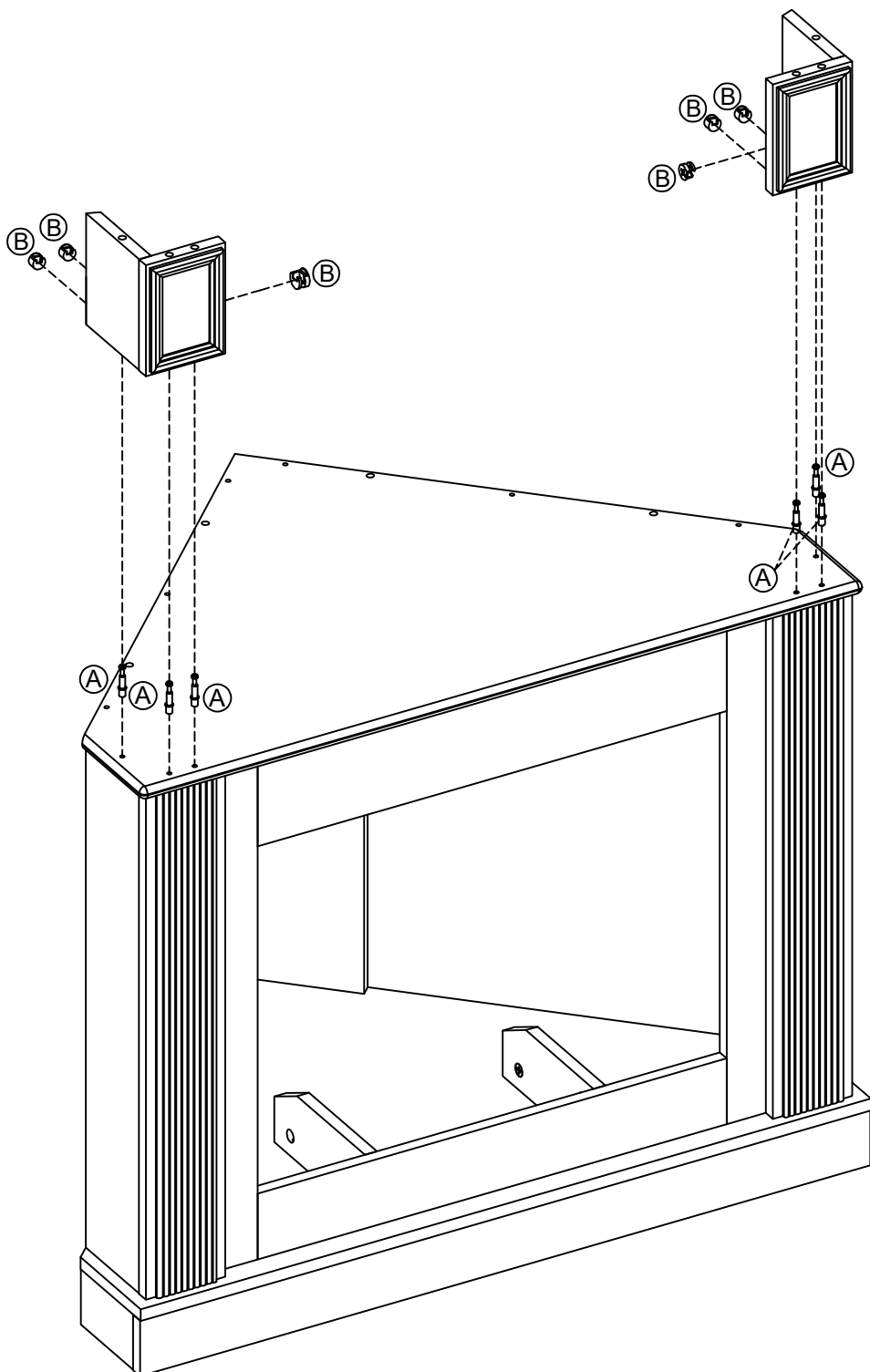
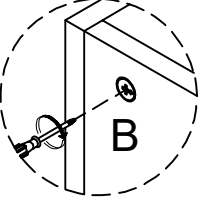
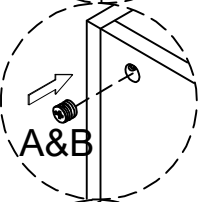
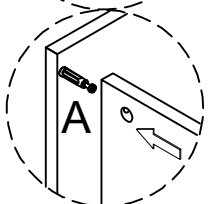
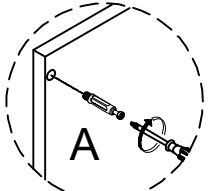

Step 17

A

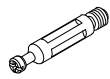

Ax6

B



Bx6

C

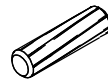

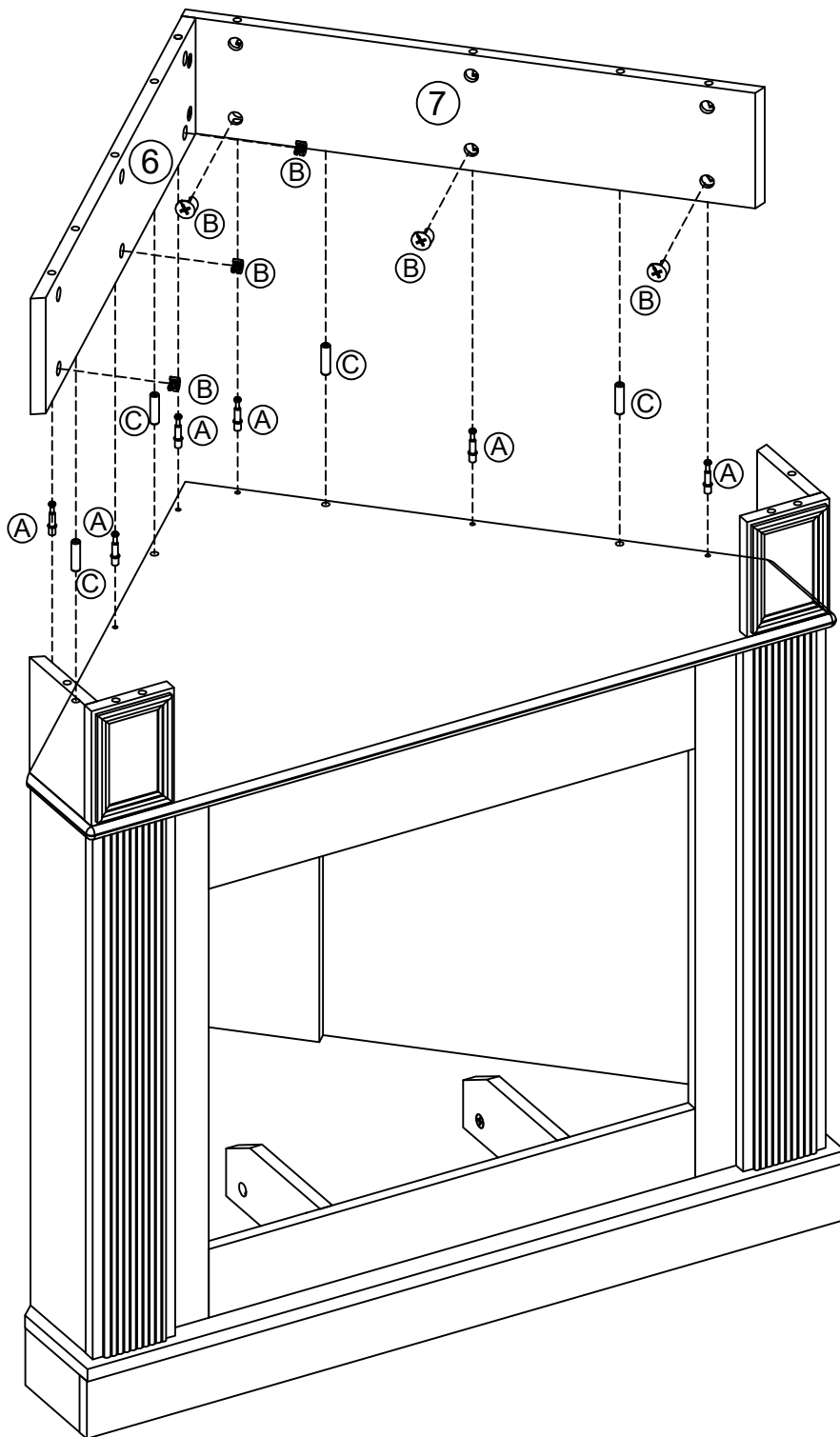
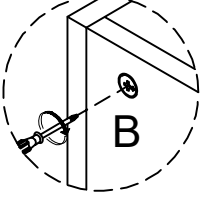
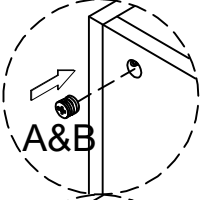
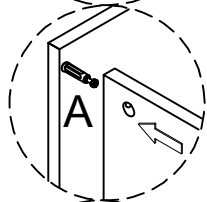
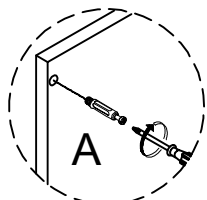

8 x 30MM

C x 4

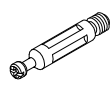

Step 18

A 
Ax2

B 
BX2

C 
8 x 30MM
Cx1

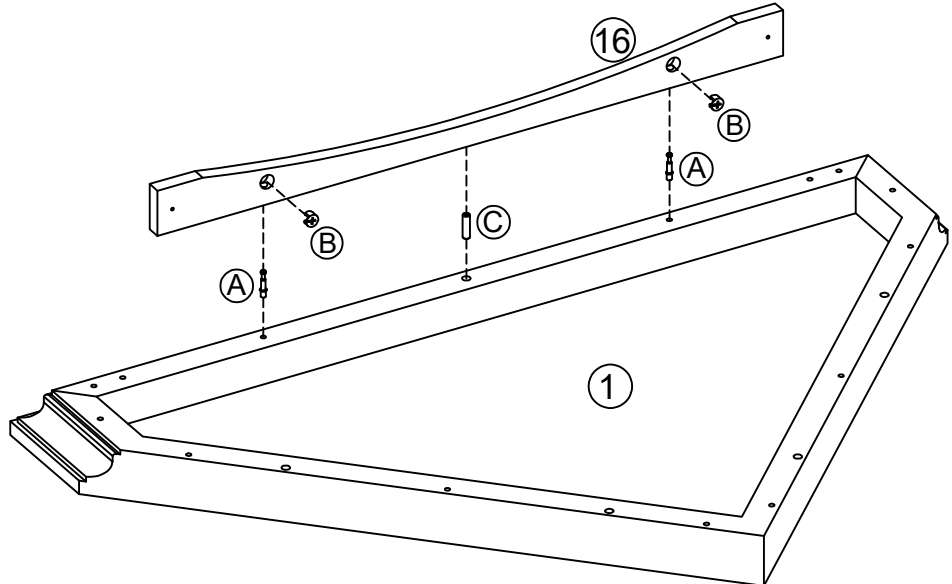

Step 19

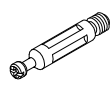
A  Ax12

B  Bx12

C  8 x 30MM
C x 4

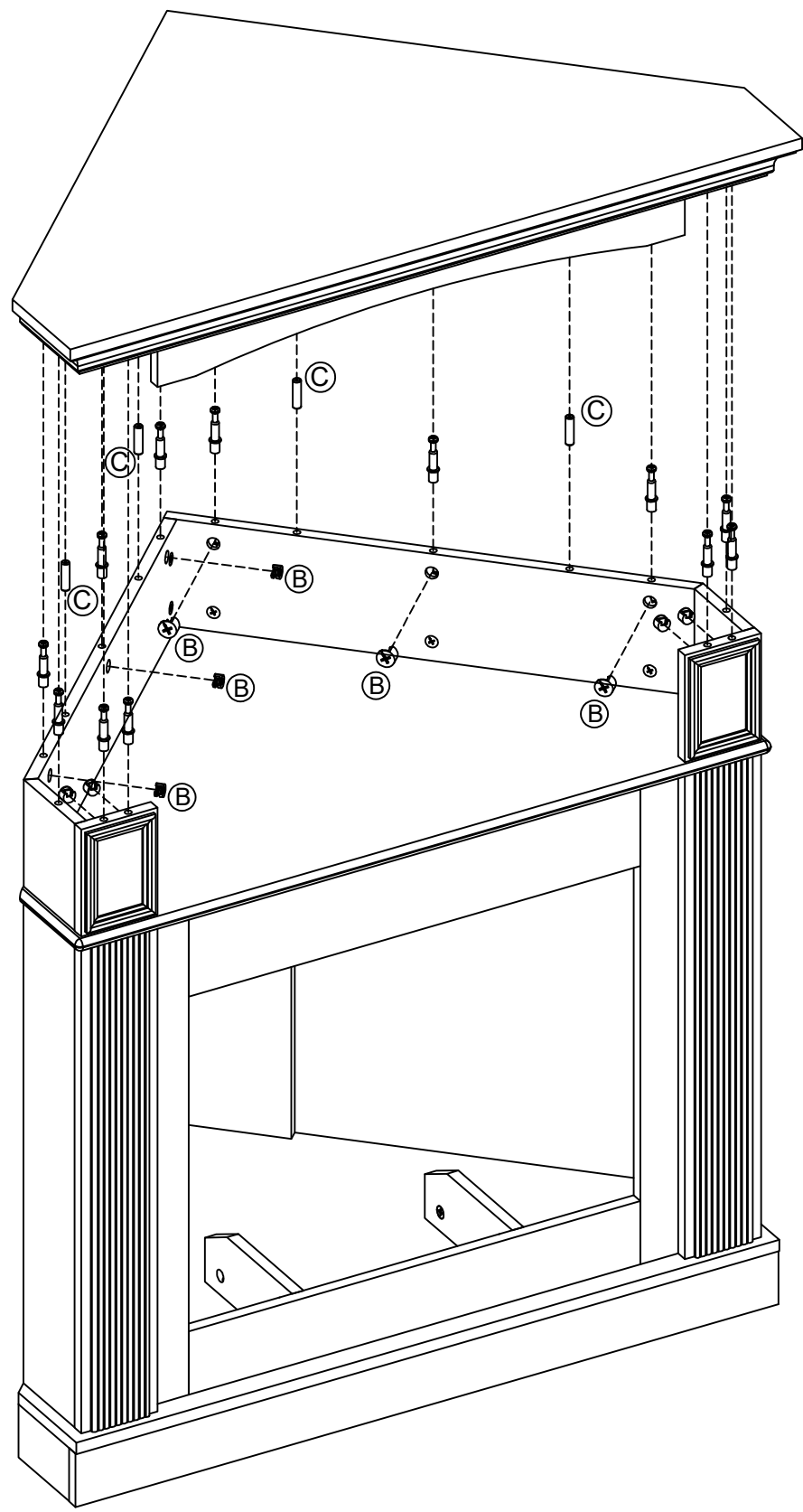
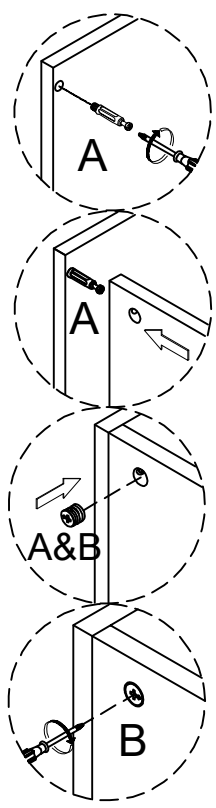

Step 20

D 
3.5 x 12MM
D x 12

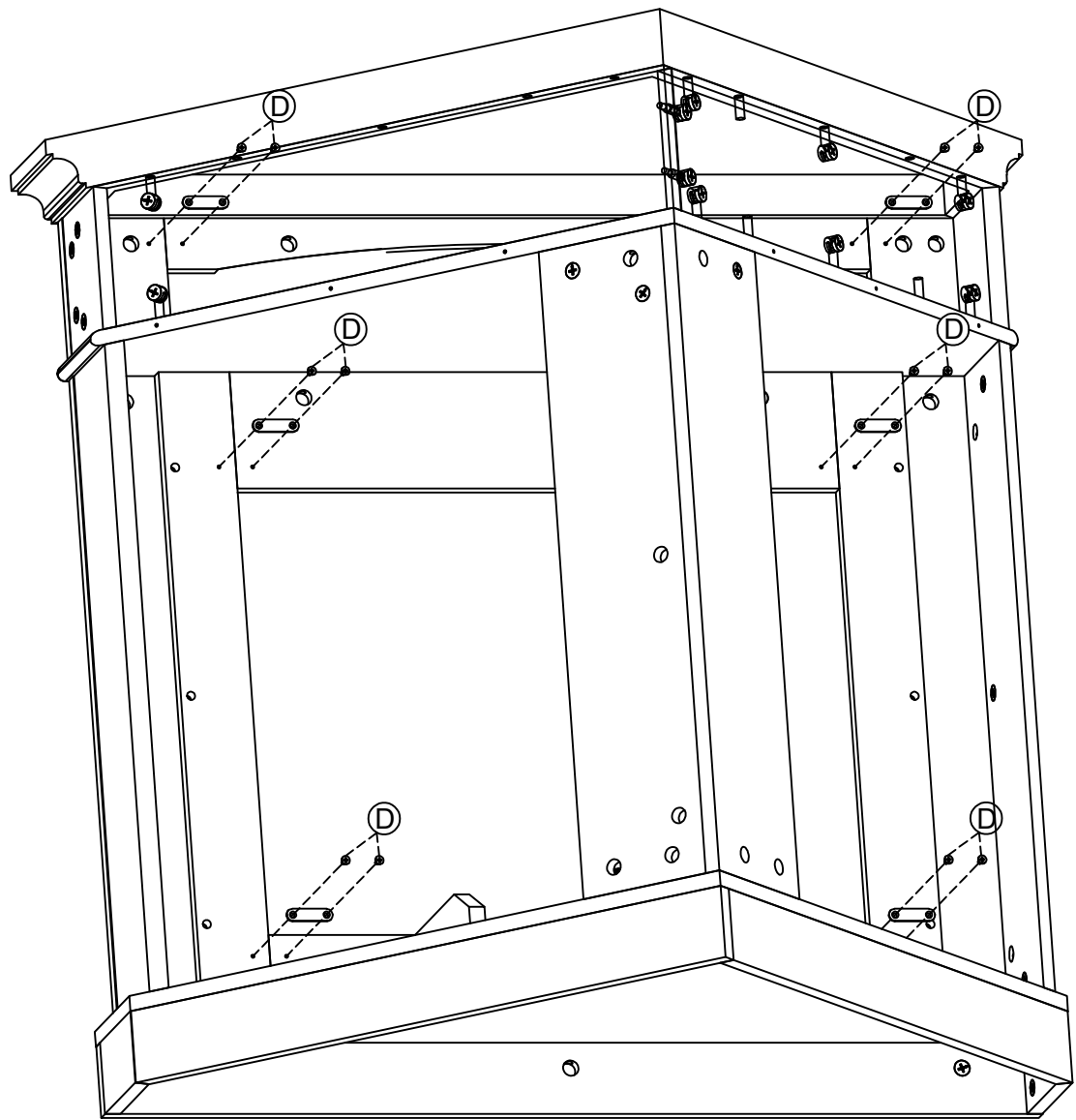

Step 21

E



3.5 x 12MM

C x 24

