

# Ceiling Fan

## Installation Manual

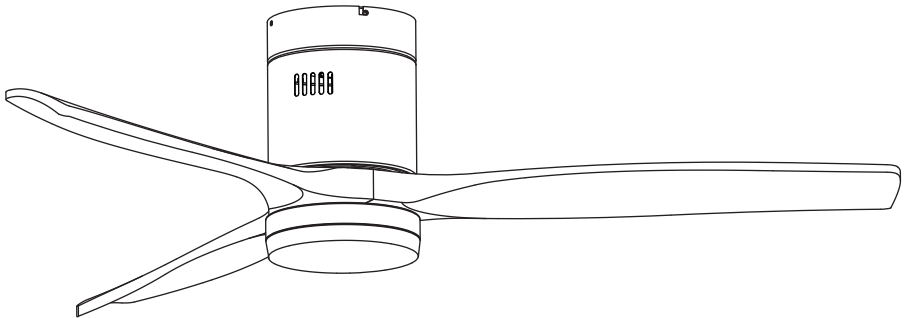

THANK YOU

We appreciate the trust and confidence you have placed in us through the purchase of this ceiling fan. We strive to continually create quality products designed to enhance your home. Thank you for choosing us!

---

Visit [www.pmwfan.com](http://www.pmwfan.com) for further assistance.

# SAFETY PRECAUTIONS

The information contained in the following pages has been prepared to ensure your maximum enjoyment of your fan. Please remove the fuse or turn off the circuit breaker to cut off the power before installing the fan. Ensure all electrical connections are in compliance with local laws, regulations and national electrical codes. If you are not familiar with electrical installation and wiring, please hire a qualified electrician or consult the wiring manual.

1. For your safety, all electrical connections and disconnections should be performed by a qualified electrician.
2. Any action performed for the electrical connection of the device must be carried out after ensuring that the general power supply is disconnected by removing the corresponding fuse or disarming the protective switch in order to ensure total isolation of the power supply.
3. When deciding where to mount the fan, be sure that there is at least 50 cm of space between the fan and any wall or other obstruction that the fan blades could collide with. The greater this distance, the more effective the air flow produced. After the fan is mounted, be sure that the blades are no less than 2.3 m above the ground.
4. The anchor point for the fan must be able to support a weight of at least 35 kgs. If mounting on a ceiling junction box, be sure that the fan is adequately supported to prevent loosening or turning.
5. The fan's electrical connection must be "grounded" (the fan's ground cable connected to the installation's grounding network) in order to avoid any branching that may be dangerous to people.
6. Do not connect the fan's power supply to any dimmers, potentiometers, or light switches, as it will cause the fan to malfunction and/or will damage the motor. The fan must be directly connected to a properly protected installation circuit (magnetothermal differential switch with the adequate size for the fan's consumption and technical specifications). Only use the fan's control to turn it on or stop it.
7. It is recommended to not use these types of fans along with gas installations simultaneously in the same room.
8. The fan must not be moving and must have come to a complete stop before changing its direction of rotation. This will prevent damage to its motor and to the control unit, when applicable.
9. Do not insert anything that could hit the fan's blades into its pathway while it is moving, as this could cause damage to people, can damage the blades, and can offset the balance of the unit, causing vibrations and wobbling.
10. After installing the fan, ensure that all fastenings are secure and tightened in order to avoid any noise caused by loose elements.
11. Due to the fan's movement, certain fastenings may become loose. Check all fastenings twice per year at a minimum in order to ensure that they are sufficiently tight. If necessary, they must be retightened.
12. The motor housing can be cleaned with a soft brush or a lint-free cloth to avoid scratching the surface. Clean the blades with a lint-free cloth. Important: Turn off the main power supply before starting any maintenance. Do not clean the fans with water or a damp cloth.
13. The fan can only operate normally after all blades are installed. If the fan is turned on without installing the blades, the receiver will detect that the fan speed is too fast and it will "Beep Beep". Then the fan will stop.
14. The light source contained in this luminaire shall only be replaced by the manufacturer or his service agent or a similar qualified person.
15. If unusual oscillating movement is observed, immediately stop using the ceiling fan and contact the manufacturer, its service agent or suitably qualified persons.
16. The replacement of parts of the safety suspension system device shall be performed by the manufacturer, its service agent or suitably qualified persons.
17. The fixing means for attachment to the ceiling such as hooks or other devices shall be fixed with a sufficient strength to withstand 4 times the weight of the ceiling fan.
18. It is recommended to inspect the connecting components of the fan at least once a year, including the horizontal pin, blade holder, hanger connection screws, and fan blades, to ensure that the product connections are still safe and reliable.

## Battery WARNING:

- Keep out of reach of children. Swallowing can lead to chemical burns, perforation of soft tissue and death. Severe burns can occur within 2 h of ingestion. Seek medical attention immediately.
- If used incorrectly or if the battery is damaged, flammable liquid may be ejected from the battery. Contact with this liquid should be avoided. If contact accidentally occurs, rinse off with water. If the liquid comes into contact with your eyes, seek additional medical attention. Liquid ejected from the battery may cause irritation or burns.
- Do not expose the appliance or battery to excessive temperatures.
- Be aware of the risk of terminals of the battery-operated appliance or battery being short-circuited by metal objects.
- Do not use modified or damaged batteries.
- Non-rechargeable batteries are not to be recharged.
- Different types of batteries or new and used batteries are not to be mixed.
- Batteries are to be inserted with the correct polarity;
- Exhausted batteries are to be removed from the appliance and safely disposed of.
- If the appliance is to be stored unused for a long period, the batteries should be removed.
- Battery: 1.5V\*2AAA

**Note:** The important warnings and instructions indicated in this manual are not guaranteed to cover all possible conditions and situations that may occur. It must be understood that common sense, precaution, and care are factors that cannot be included in all products. These factors can and must only be provided by the user who maintains and enjoys this fan.

## DIMENSIONS

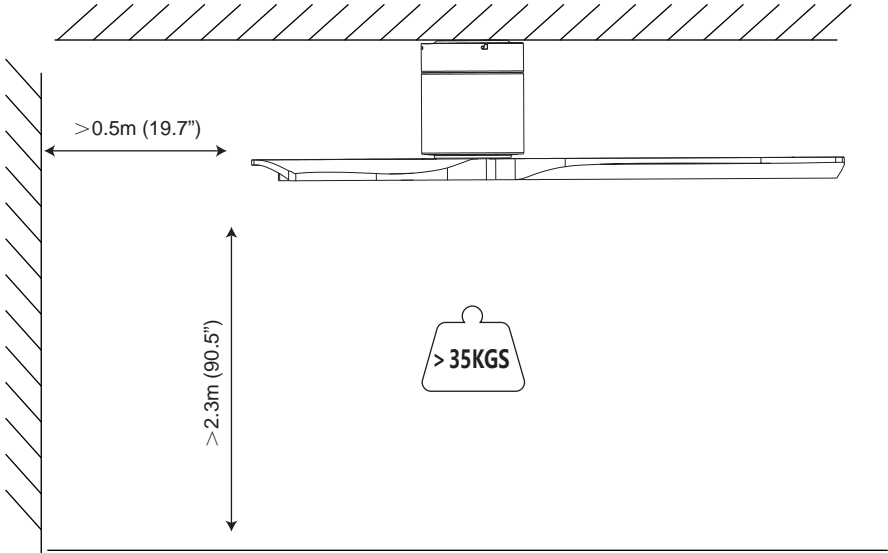

## TOOLS REQUIRED



Step  
ladder



pliers

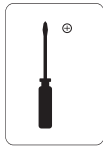

Phillips  
screwdriver

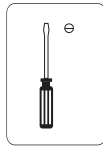

Flat blade  
screwdriver



Electrical  
tape



tape  
measure

# PACKAGE LIST



Unpack your fan and check the contents. You should have the following:

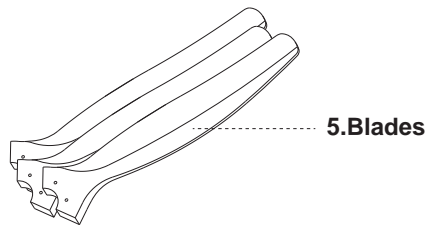
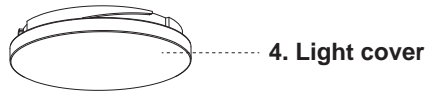
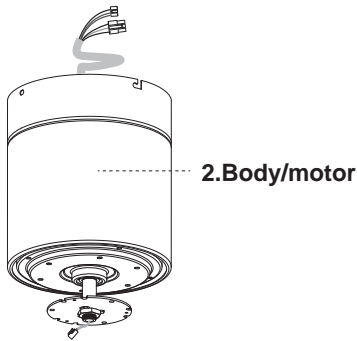
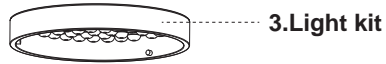
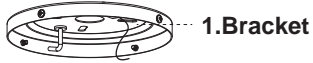

Remote control unit

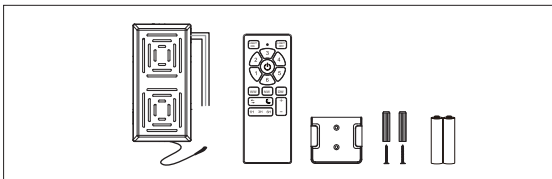

Blade balancing kit

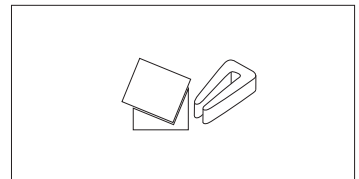

Screw package

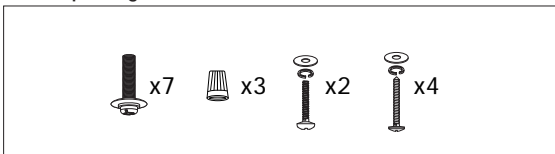

Instructions manual

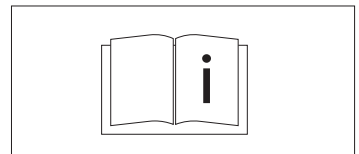

• Note: The Illustrations in this manual are for explanation purposes only and may differ from the actual unit. It is subjected to change without prior notice for further improvements.

# Ceiling Fan

Questions, problems, missing parts? Before returning to the store,  
visit [www.pmwfan.com](http://www.pmwfan.com) for further assistance.

Retain this manual for future use.

**Manufacturer:** Zhongshan Miaowang Electrical Appliance Co., Ltd.

**Address:** Building C, No.10, Qingfu Road, Henglan Town, Zhongshan City, Guangdong Province,CN

**Website:** [www.pmwfan.com](http://www.pmwfan.com)

**Tech Support Telephone:** +12092272409

**Tech Support Email Address:** [support@pmwfan.com](mailto:support@pmwfan.com)

