

ASSEMBLY INSTRUCTIONS

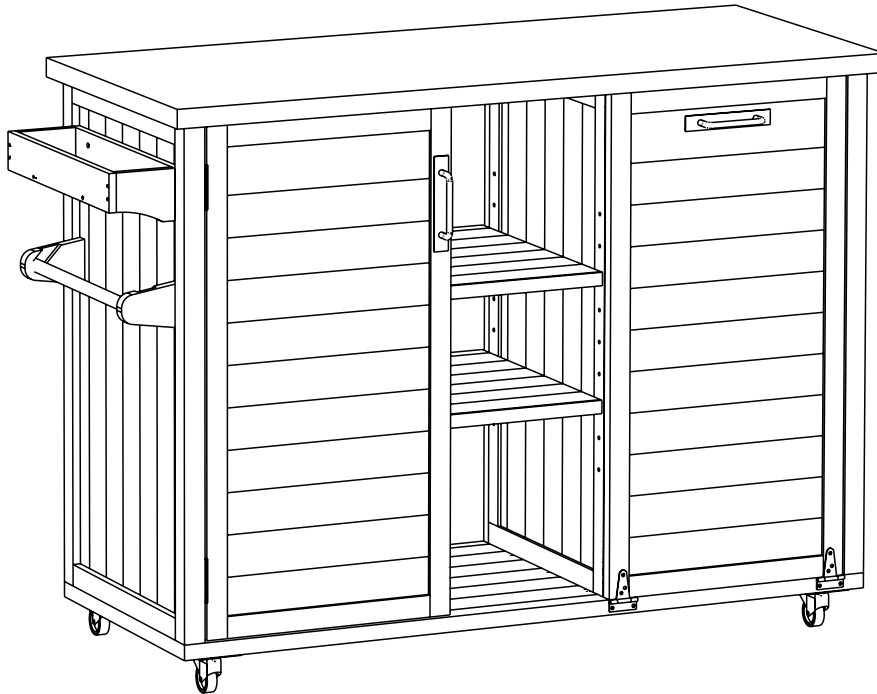







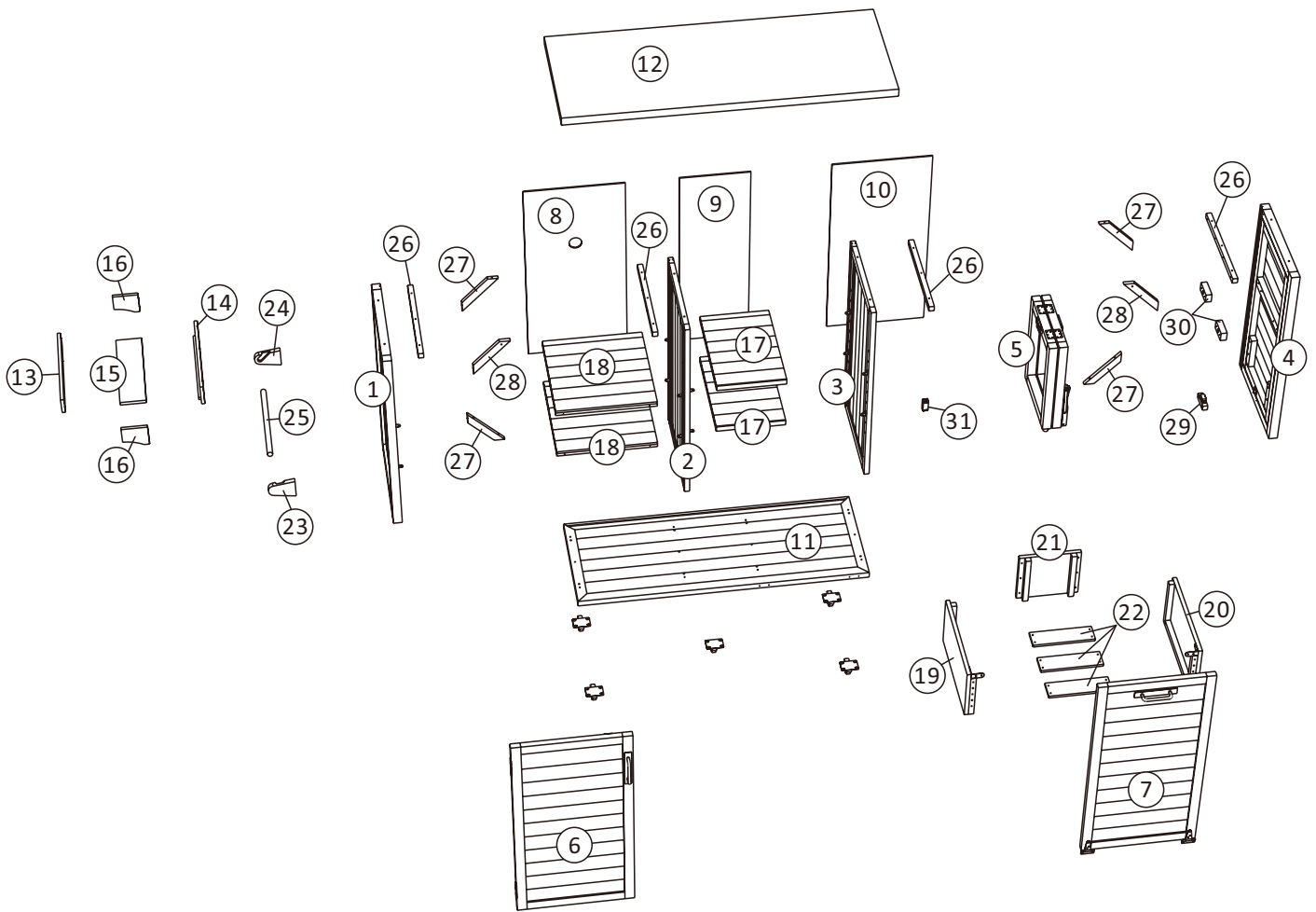

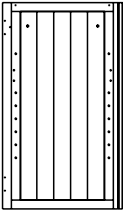
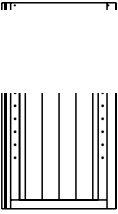

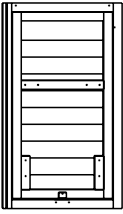
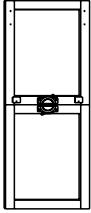

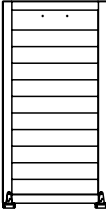
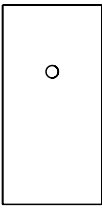

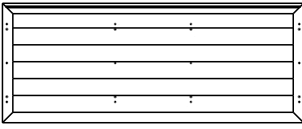
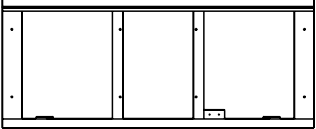
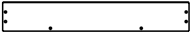
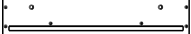



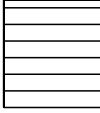

IMPORTANT NOTE:



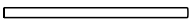
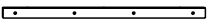
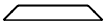
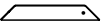



















- ① PLACE ALL PARTS ON A CLEAN AND SMOOTH SURFACE SUCH AS A RUG OR CARPET TO AVOID THE PARTS FROM BEING SCRATCHED.
- ② BEFORE YOU BEGIN, KINDLY FOLLOW THE ASSEMBLY INSTRUCTIONS STEP BY STEP.
- ③ DO NOT TIGHTEN ALL SCREWS AND BOLTS UNTIL THIS ITEM IS FULLY SET-UP.

Detail View



1		2		3		4	
	1pc		1pc		1pc		1pc
5		6		7		8	
	1pc		1pc		1pc		1pc
9		10		11		12	
	1pc		1pc		1pc		1pc
13		14		15		16	
	1pc		1pc		1pc		2pcs
17		18		19		20	
	2pcs		2pcs		1pc		1pc
21		22		23		24	
	1pc		3pcs		1pc		1pc
25		26		27		28	
	1pc		4pcs		4pcs		2pcs
29		30		31			
	1pc		2pcs		1pc		

Hardware List

A	 Ø 3.5*45 11pcs	B	 Ø 3.5*40 32pcs	C	 Ø 3.5*35 21pcs	D	 Ø 3.0*30 12pcs
E	 Ø 3.5*25 10pcs	F	 Ø 3.0*25 24pcs	G	 Ø 3.0*16 20pcs	H	 Ø 3.0*18 4pcs
I	 Ø 6.0*20 20pcs	J	 Ø 6.0*25 2pcs	K	 23pcs	L	 16pcs
M	 2pcs	N	 1pc	O	 1pc	P	 2pcs
Q	 2pcs	R	 1pc	S	 4pcs	T	 2pcs
U	 4pcs	V	 1pc				

ASSEMBLY TOOLS REQUIRED(NOT INCLUDED)



PLEASE BE CAREFUL DO NOT DAMAGE THE HOLE POSITION WHEN YOU USE POWERTOOLS!

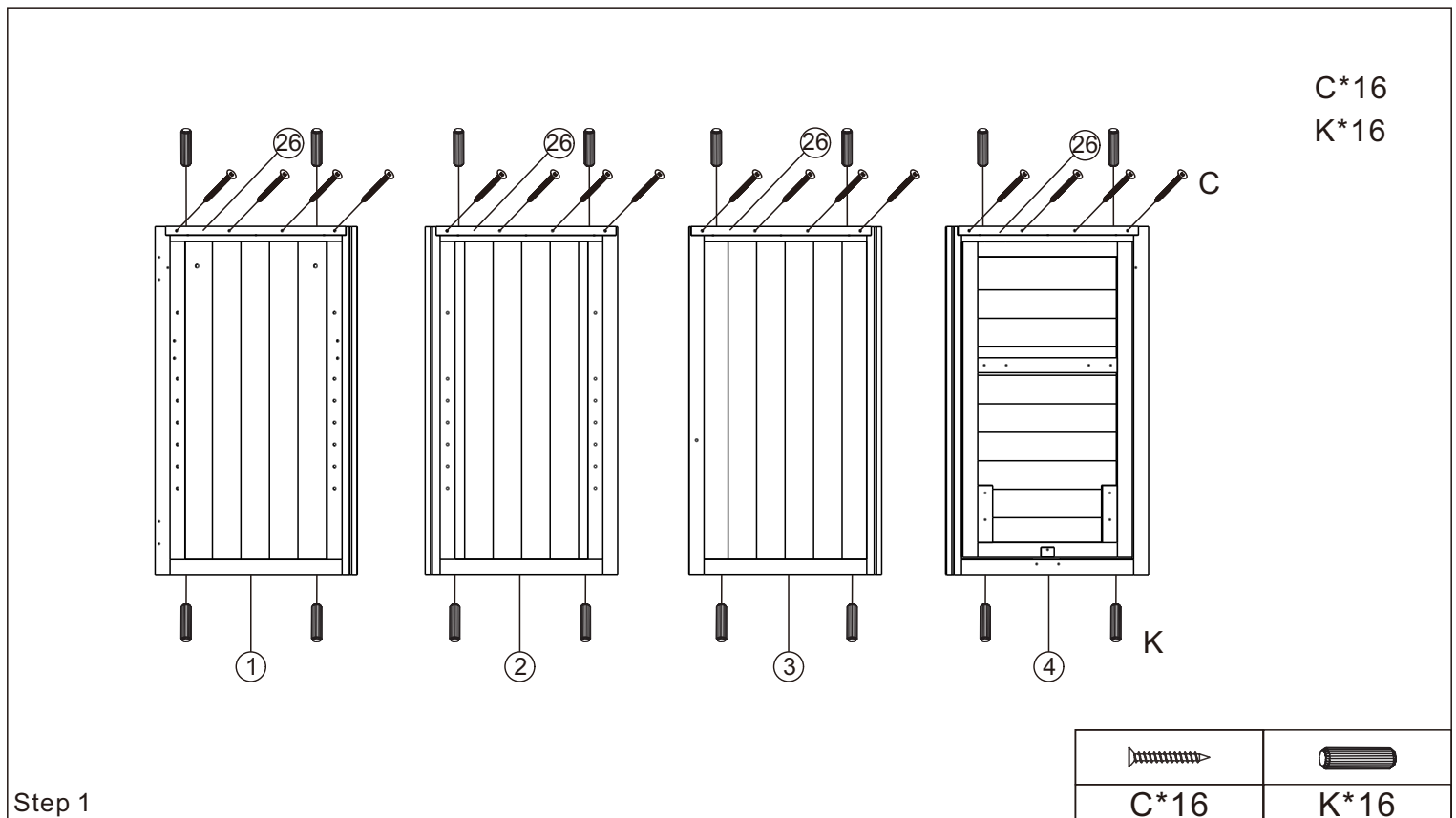

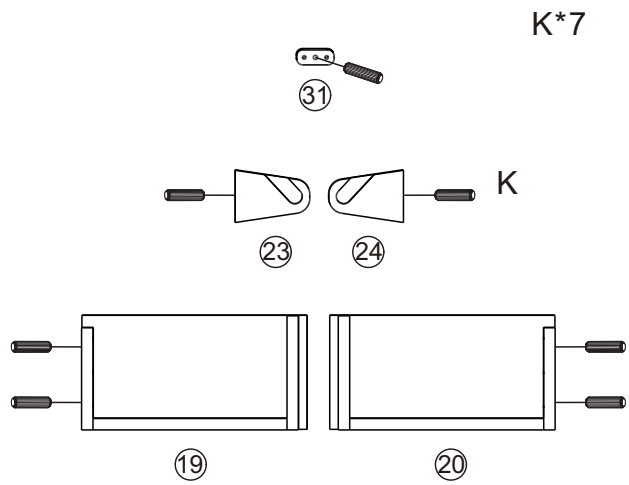

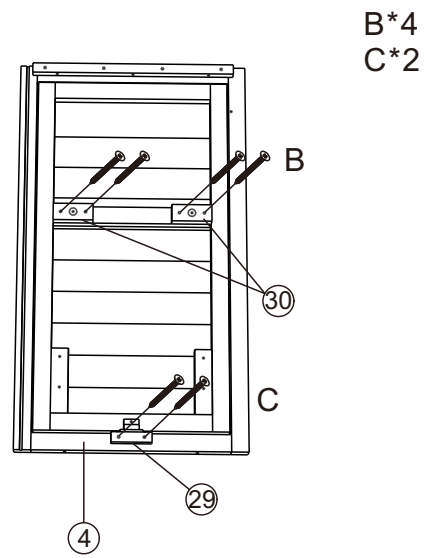

Step 2

K*7



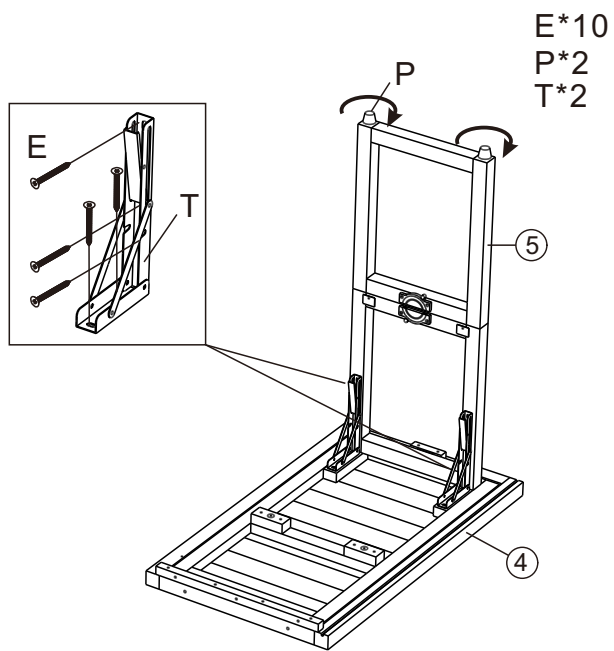

Step 3

	
B*4	C*2



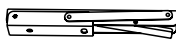

Step 4

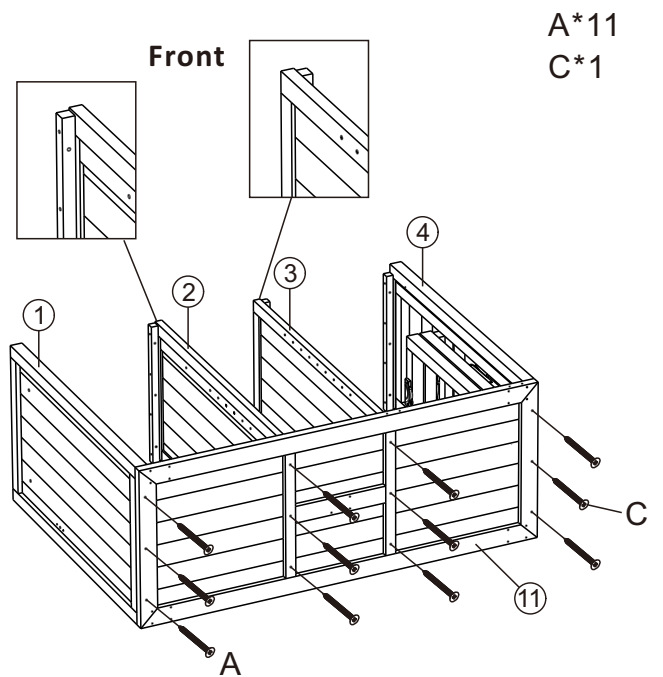
		
E*10	P*2	T*2



Step 5

	
A*11	C*1

I*20
R*1
S*4

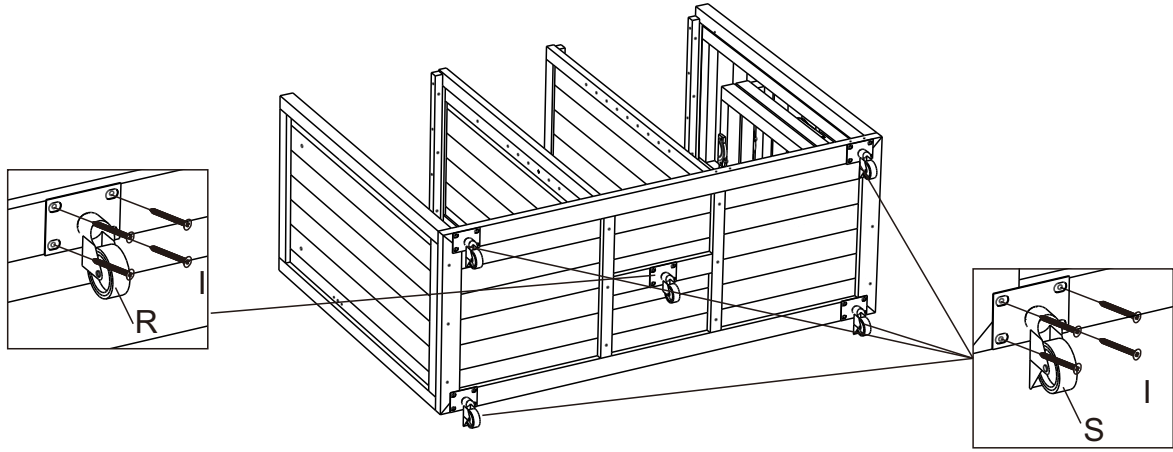

Step 6

		
I*20	R*1	S*4

F*6

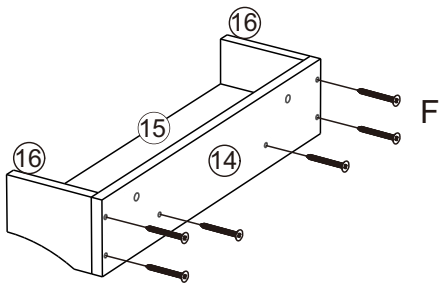

Step 7

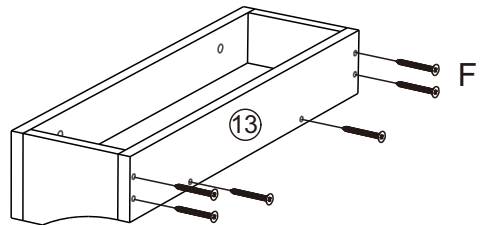

F*6

F*6



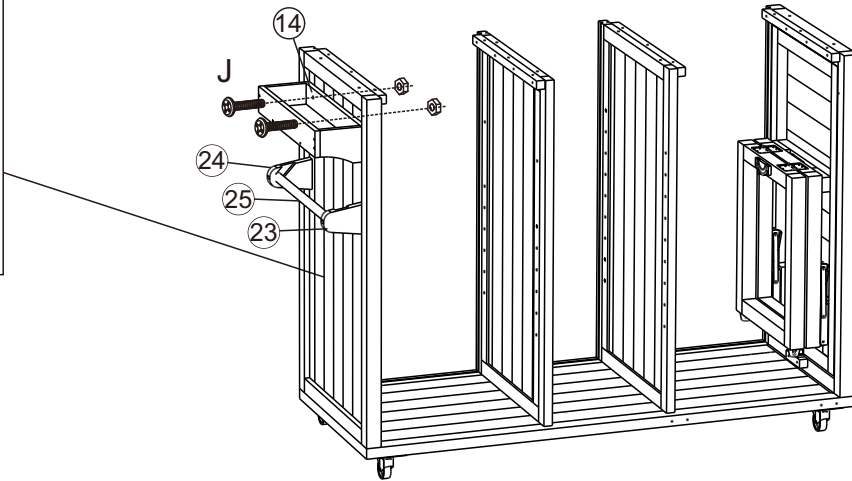
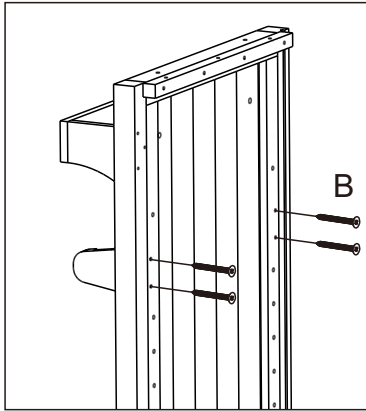

Step 8



F*6



B*4
J*2

Step 9

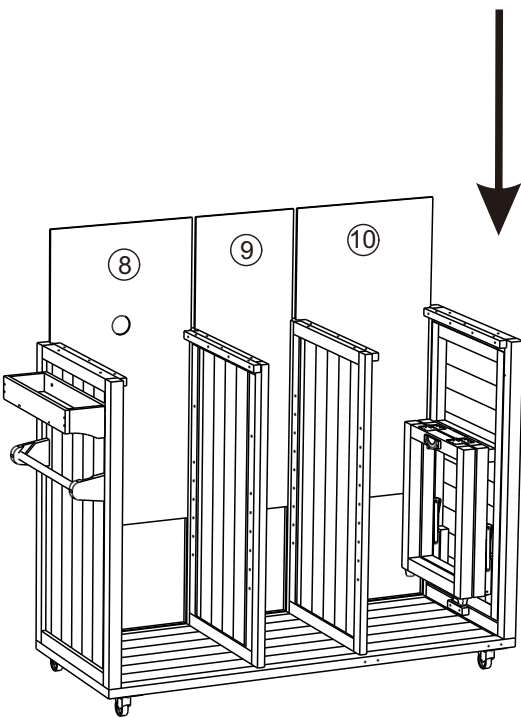
	
B*4	J*2



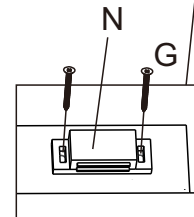
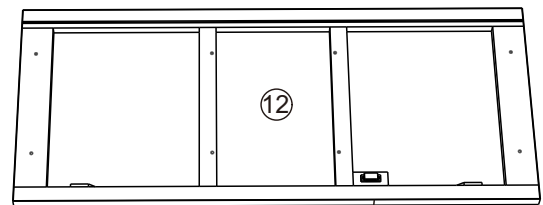

Step 10



G*2
N*1

Step 11

	
G*2	N*1

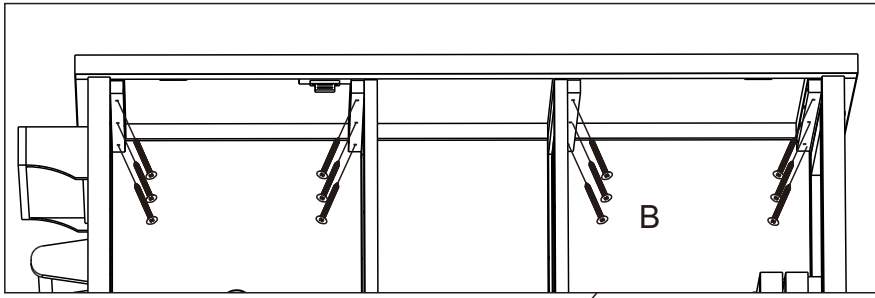

B*12

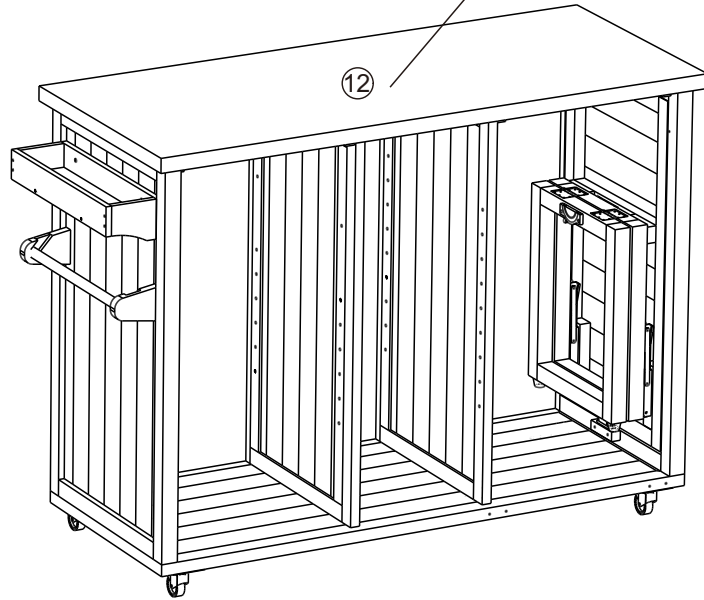

Step 12

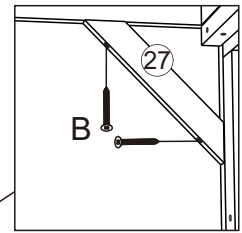
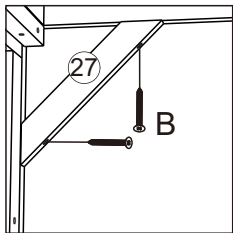
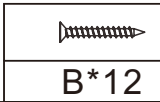

B*8

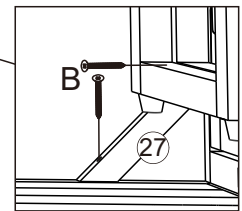
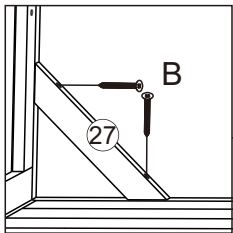

Step 13

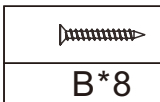

B*4

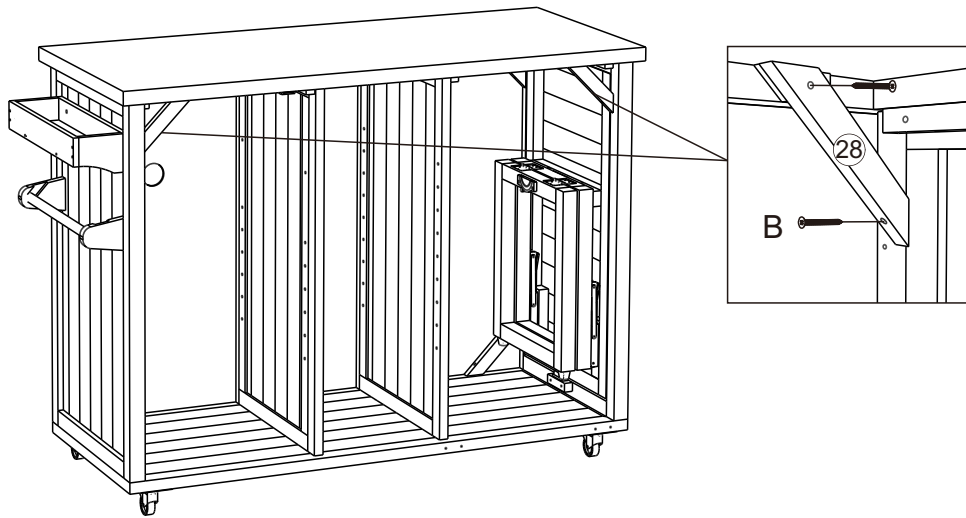

Step 14



B*4

L*16

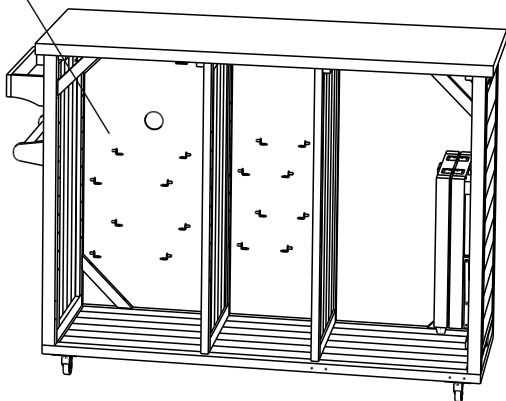
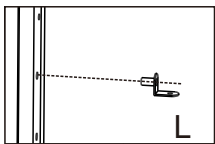

Step 15



L*16

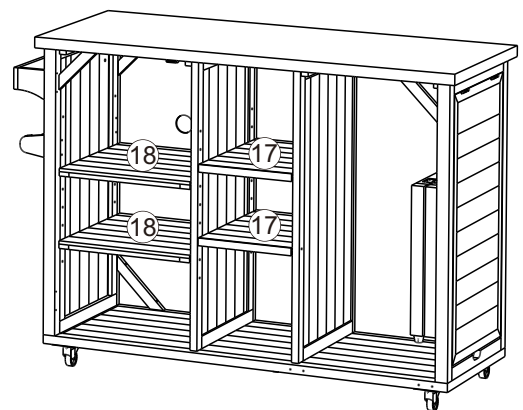

Step 16

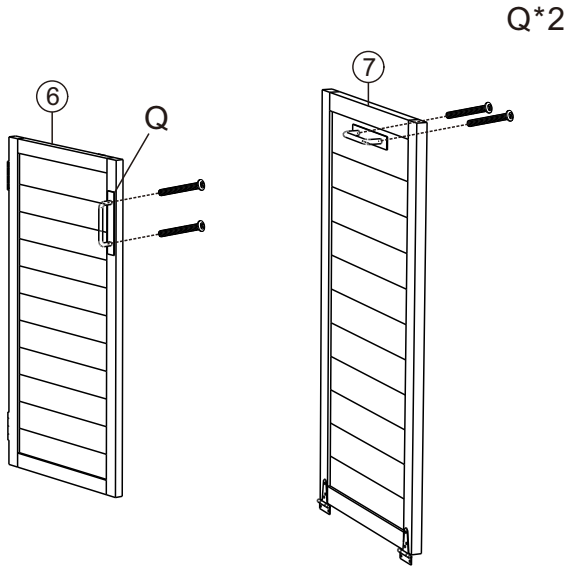

Step 17

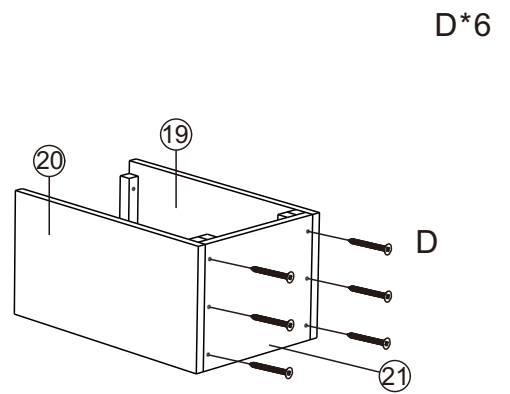
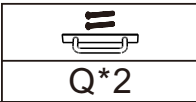

Step 18

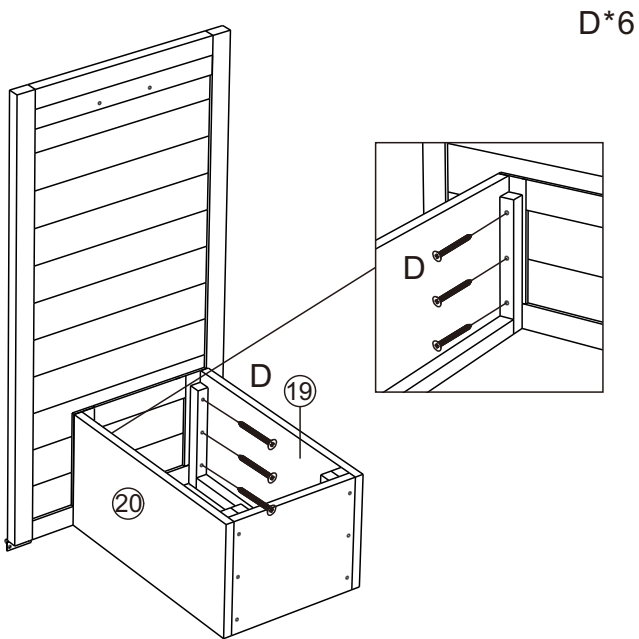
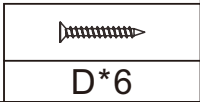

Step 19

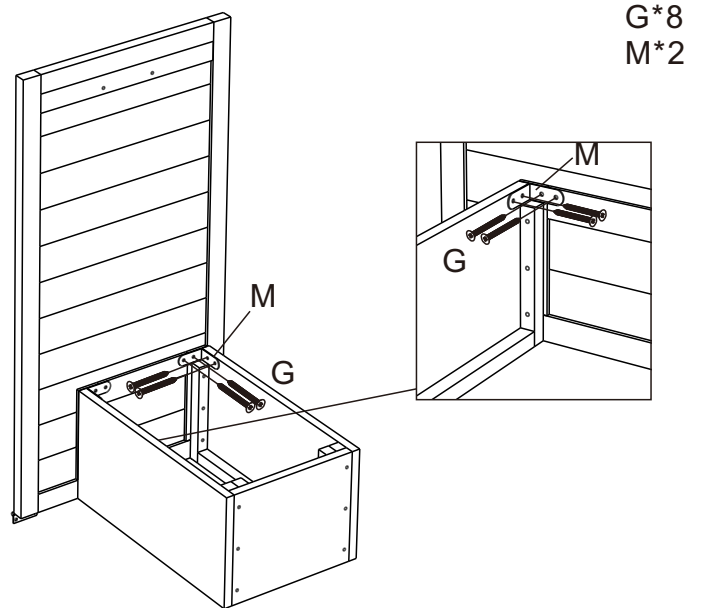
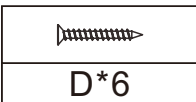

Step 20

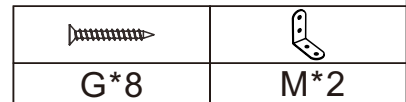

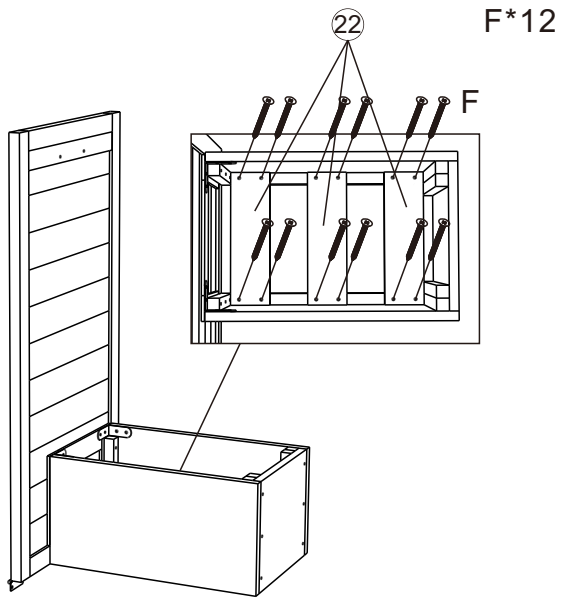

Step 21

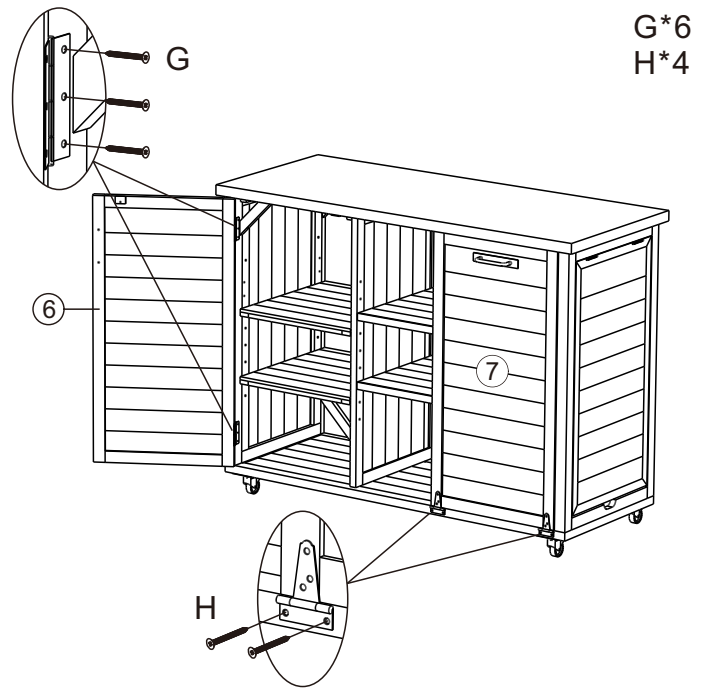
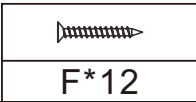

Step 22

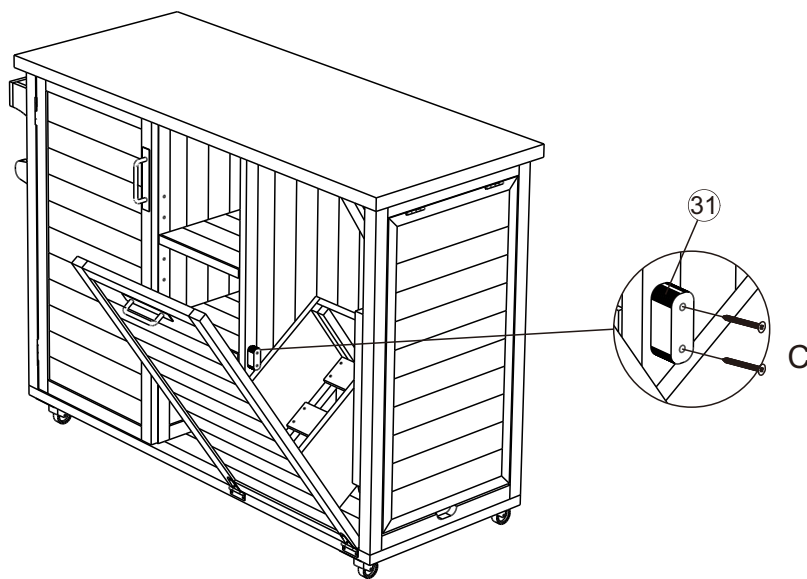
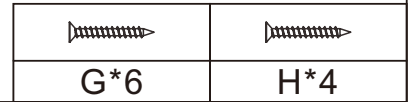

Step 23

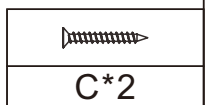

C*2



G*4
O*1





Step 24

	
G*4	O*1

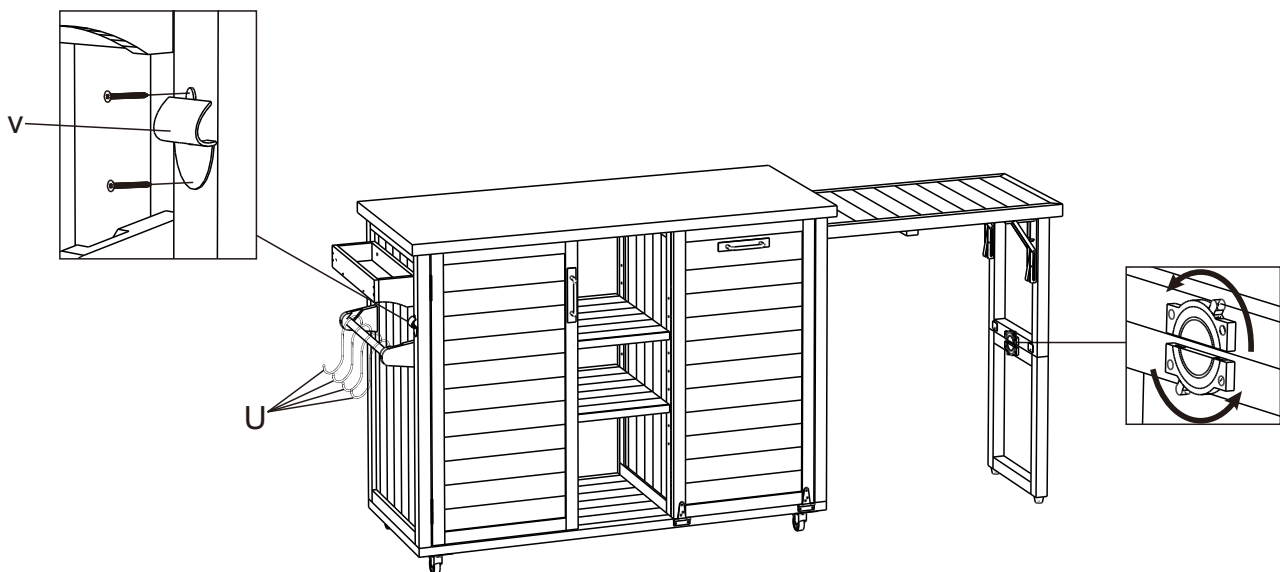
U*4
V*1



Step 25

	
U*4	V*1