

# ASSEMBLY INSTRUCTIONS

1. Before installation, please read the Assembly Instruction carefully.
2. Please check whether the Parts and Hardware are consistent with the list.
3. It is normal for the sealed environment to smell, not a product quality problem.

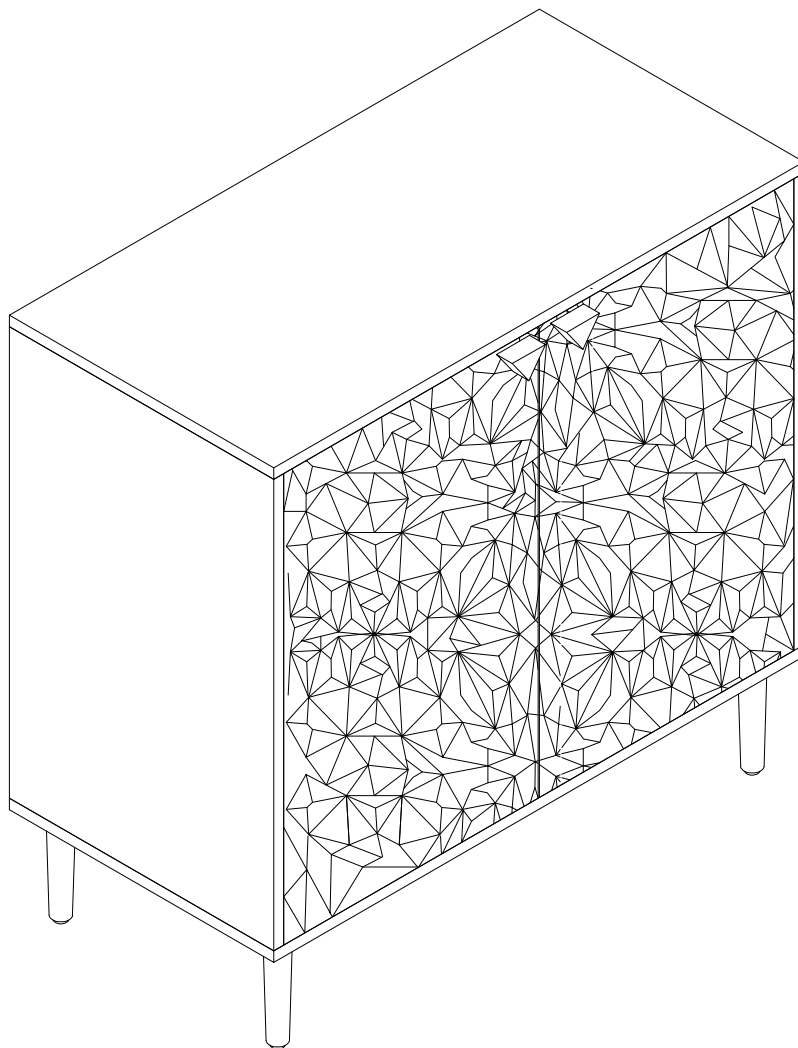

Phone number: 303-747-4421



service@clihome.net

Web: www.clihome.net

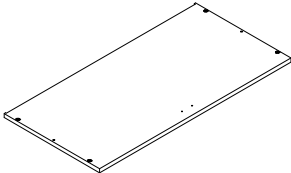
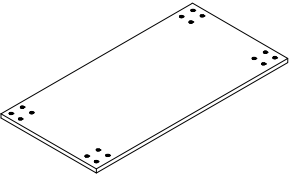

MADE IN CHINA

# ASSEMBLY INSTRUCTIONS

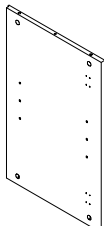
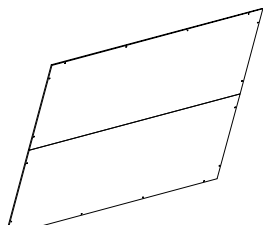
## Part List:



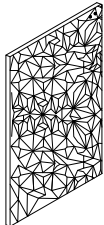
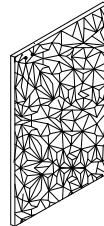
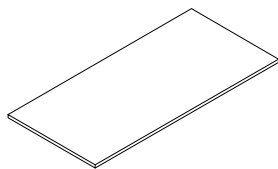
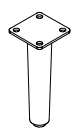



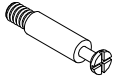

ITEM	DESCRIPTION	PART	QTY
1	Top panel		1
2	Bottom panel		1
3	Left side panel		1
4	Right side panel		1
5	Back panel		1

## Part List:







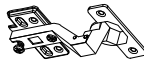

ITEM	DESCRIPTION	PART	QTY
6	Left door		1
7	Right door		1
8	Adjustable shelf		1
9	Leg		4
10	Door block		1

## ASSEMBLY INSTRUCTION

## Hardware List:

ITEM	DESCRIPTION	PART	QTY
A	Camlock bolt		8
B	Camlock		8
C	Wooden dowel	 $\Phi 6 * 30 \text{mm}$	4
D	Bolt	 $\Phi 1/4" * 1/2"$	16
E	Allen wrench		1
F	Flat head screw	 $\Phi 4 * 25 \text{mm}$	2
G	Handle		2
H	Machine screw	 $\Phi 5/32" * 4/5"$	4

## Hardware List:

ITEM	DESCRIPTION	PART	QTY
I	Door fitting		4
J	Round head screw	 $\Phi 4 * 14 \text{mm}$	24
K	Back screw	 $\Phi 3 * 12 \text{mm}$	16
L	Shelf support		4
M	Safety wall strap		1
N	Plastic anchor		1
O	Mounting screw	 $\Phi 4 * 38 \text{mm}$	1
P	Washer		1

## ASSEMBLY INSTRUCTION

- \* Required screwdriver & mallet, not included.
- \* Before discarding packing materials, please check to make sure that all parts and hardware is present.
- \* Two people needed for assembly.
- \* Please follow the instructions closely; do not over tighten screws or bolts unless instructed.
- \* After a few days from initial assembly, the product may have acclimated to the new environment. Please retighten the hardware.

### Guideline For Assembling of Cam Lock(A & B)

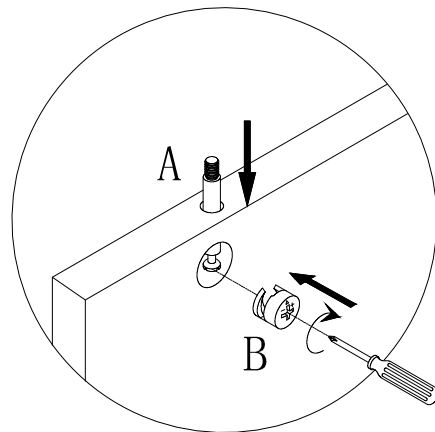
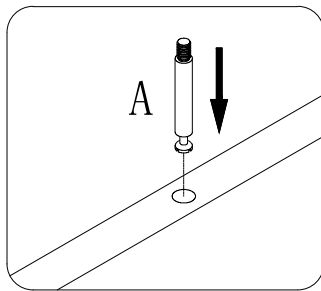



Screw camlock bolt (A) to wood part.

Do not assemble camlock (B) unless instructed.

To assemble camlock (B), ensure long side of the + is facing the bolt (A) before inserting into hole.

# ASSEMBLY INSTRUCTION

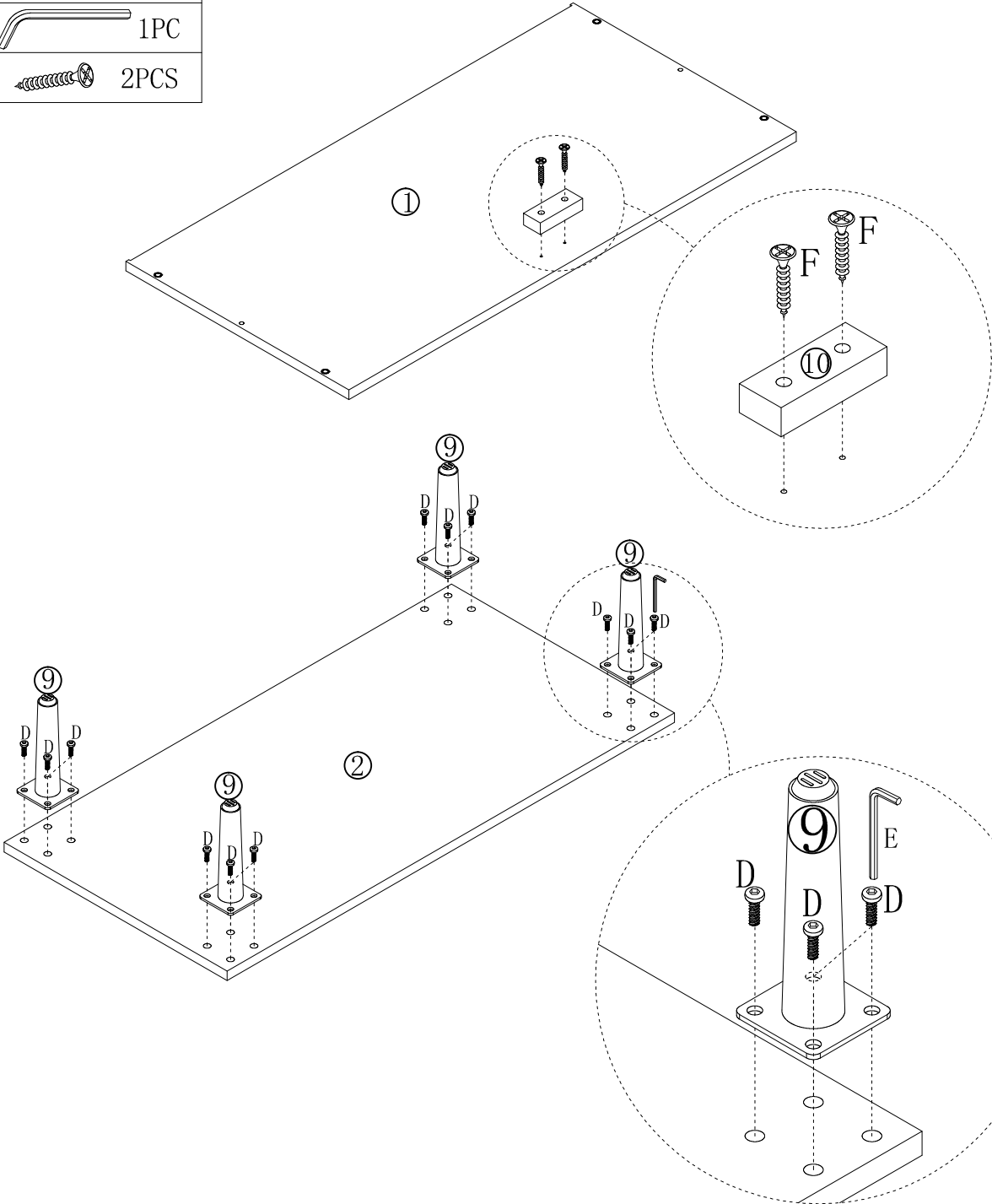

## STEP 1

- D:  16PCS
- E:  1PC
- F:  2PCS



# ASSEMBLY INSTRUCTION

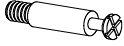

## STEP 2

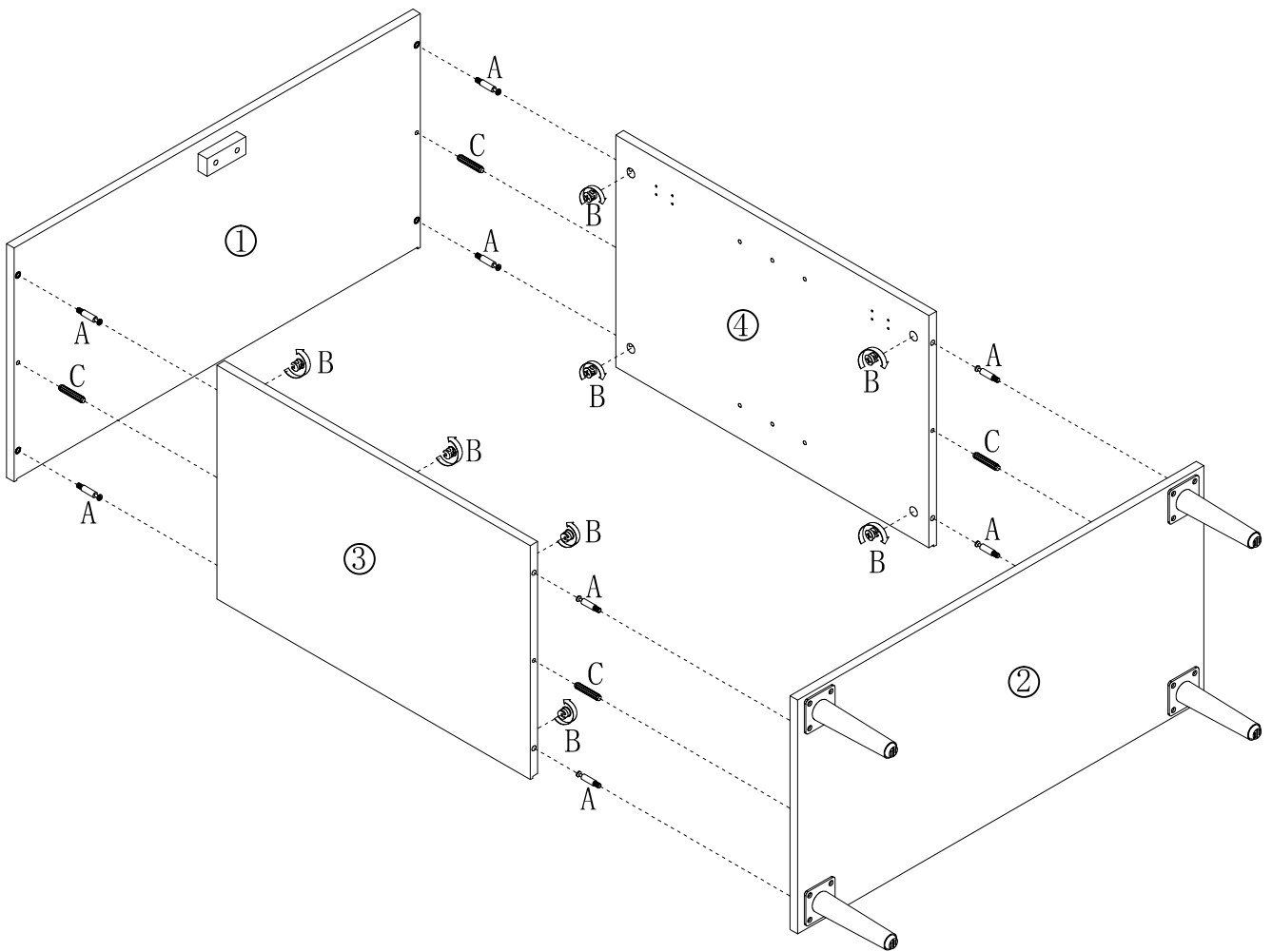
A:		8PCS
B:		8PCS
C:		4PCS





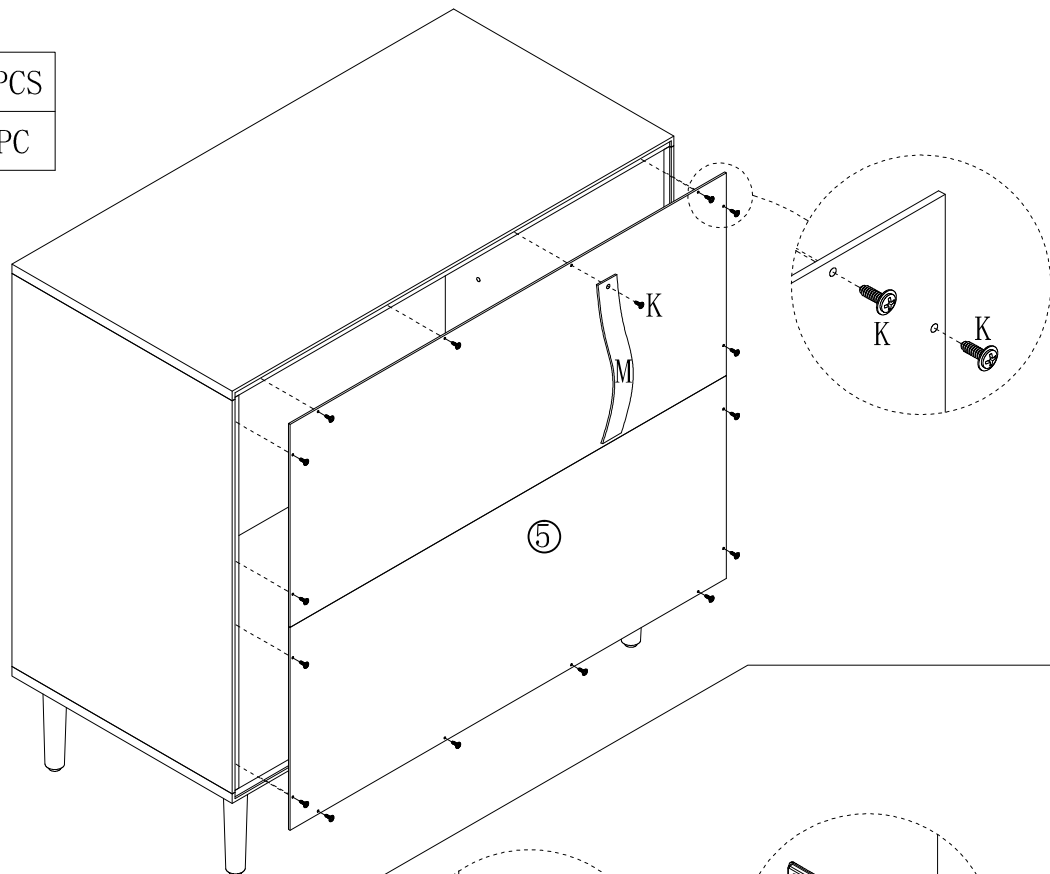

# ASSEMBLY INSTRUCTION

## STEP 3

K:		16PCS
M:		1PC



## STEP 4

G:		2PCS
H:		4PCS
I:		4PCS
J:		8PCS

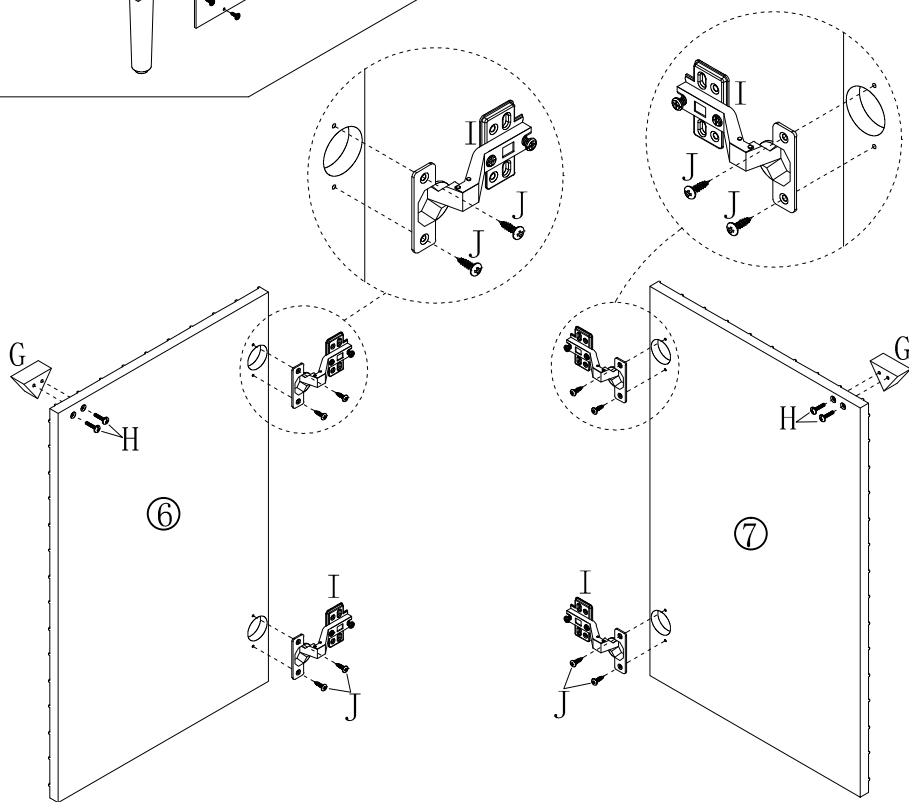

# ASSEMBLY INSTRUCTION

## STEP 5

J:  16PCS

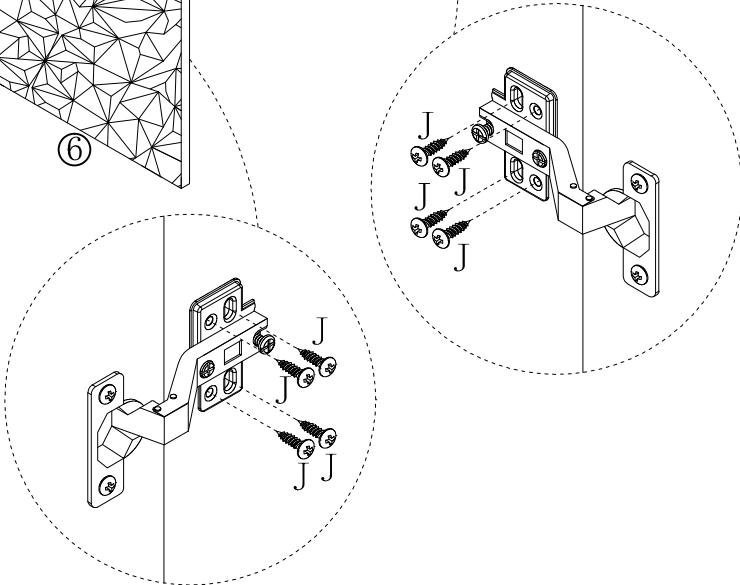
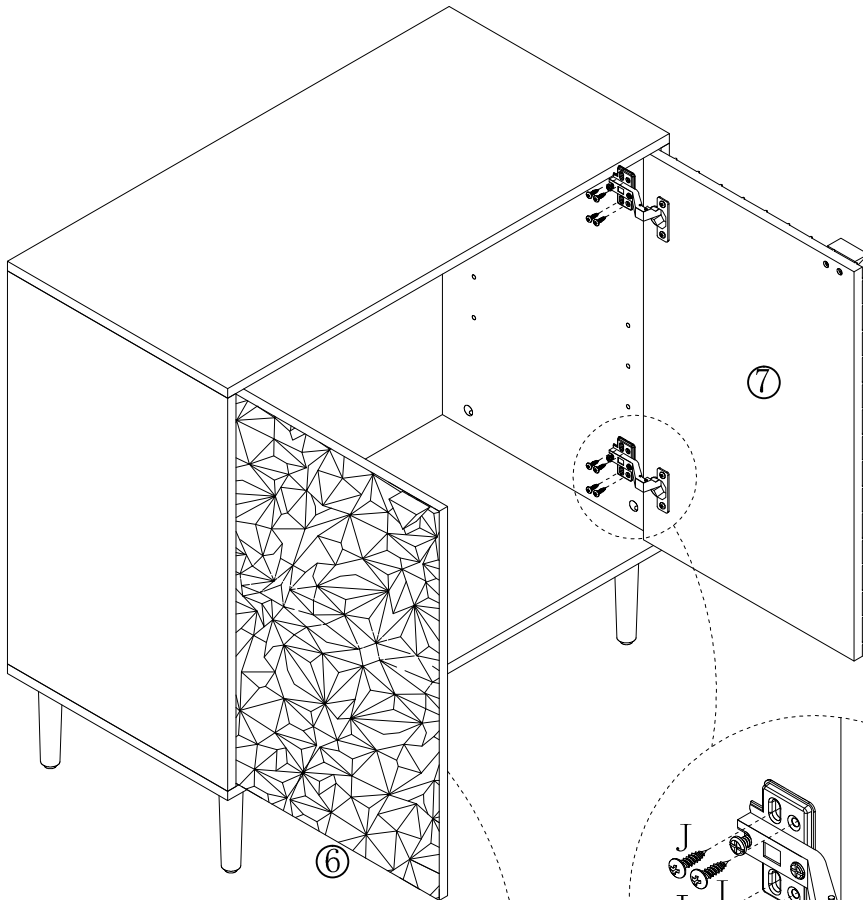

## DOOR FITTING

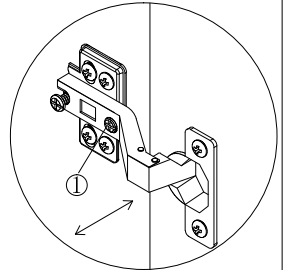

To adjust in width

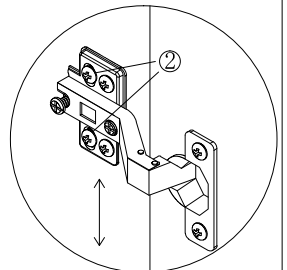

To adjust in height

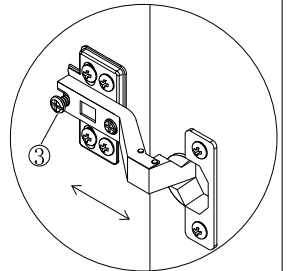

To adjust in depth

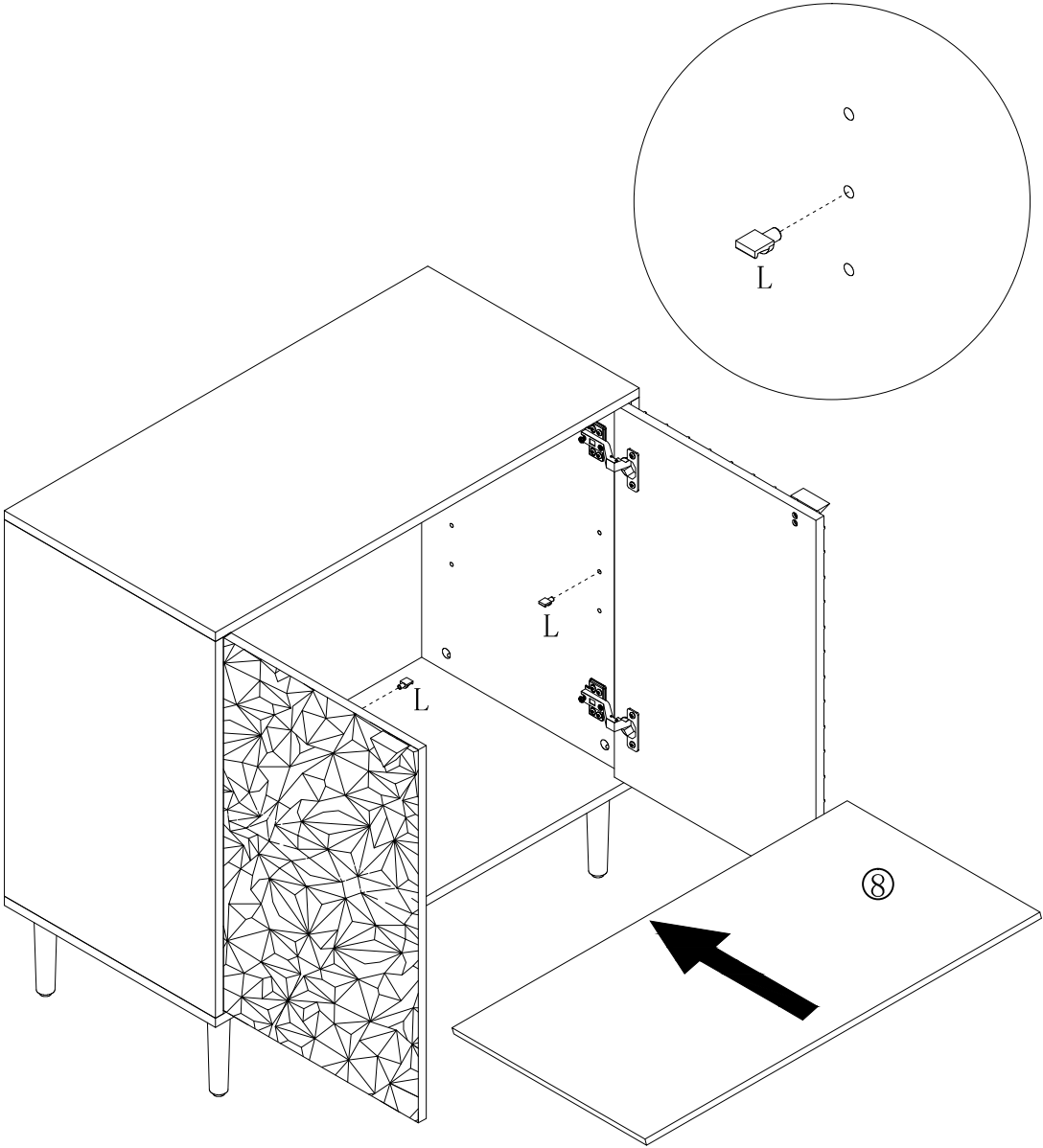

STEP 6

L:  4PCS



# ASSEMBLY INSTRUCTION

## STEP 7

N:		1PC
O:		1PC
P:		1PC

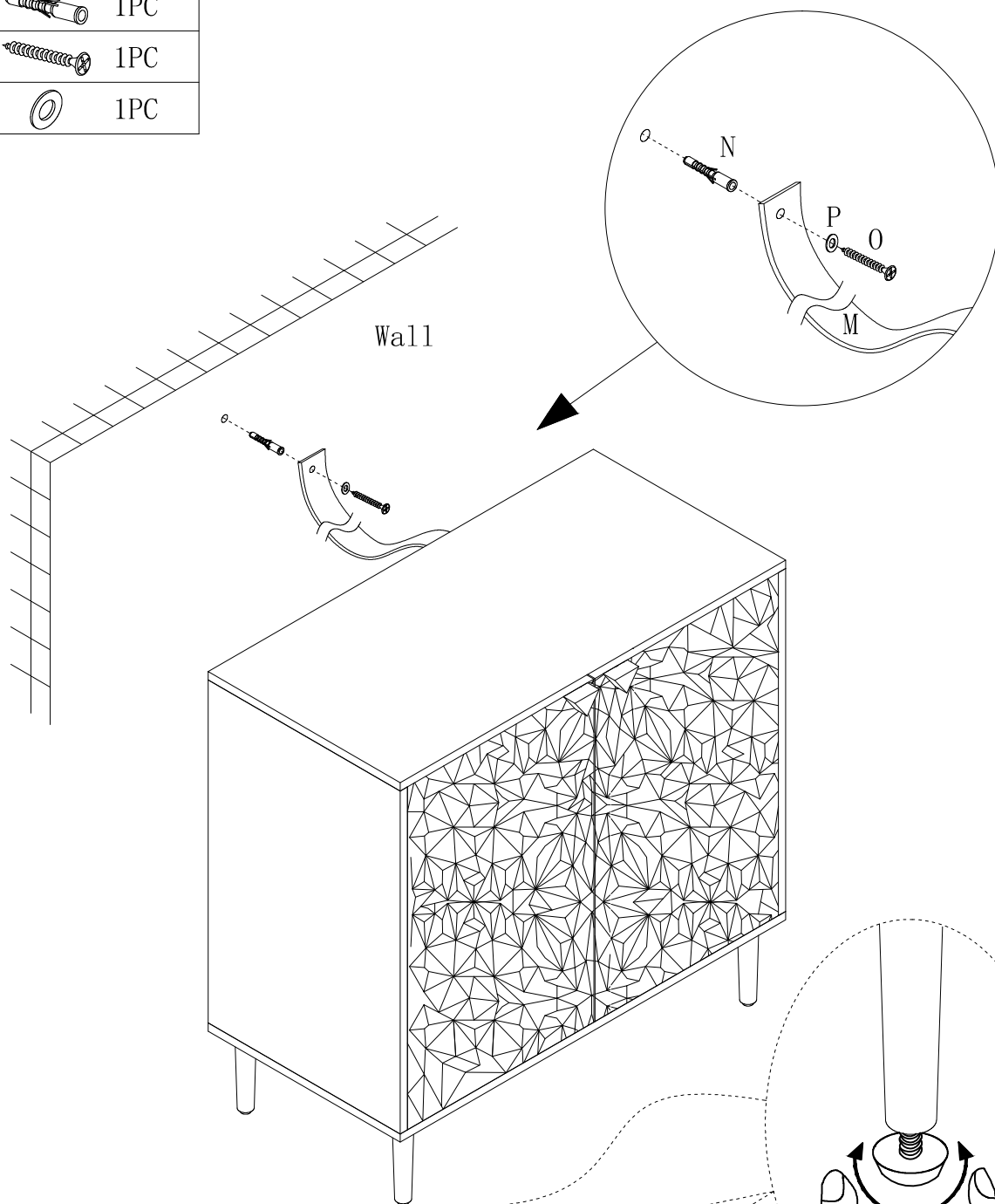

After installation, adjust the adjustable foot to keep the cabinet balanced and align the door.