

# ASSEMBLY AND INSTALLATION INSTRUCTIONS

H0176

**WARNING:** TO AVOID RISK OF ELECTRICAL SHOCK, BE SURE TO SHUT OFF POWER BEFORE INSTALLING OR SERVICING THIS FIXTURE.

**NOTES:** 1. Before installing, consult local electrical codes for wiring and grounding requirements.  
2. READ AND SAVE THESE INSTRUCTIONS.

## Hardware Package (included):

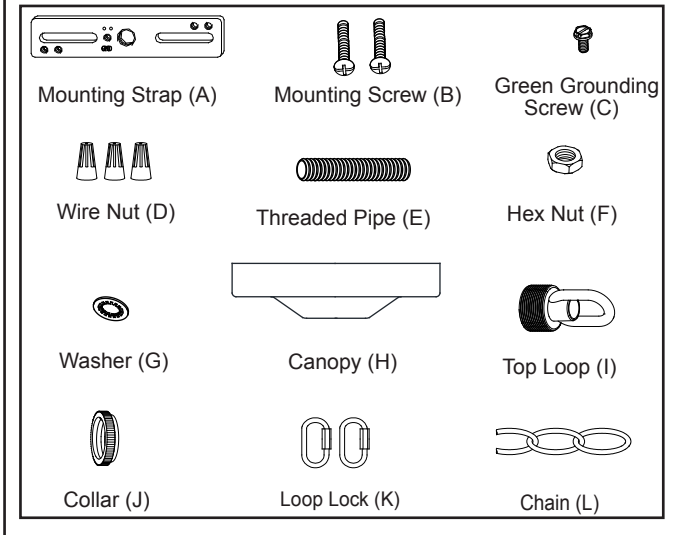

## Installation Steps

Turn off the power at fuse or circuit box

1. Attach the nipple to the mounting strap, and then secure it with a washer and a hex nut.
2. Attach the mounting strap to the outlet box by using two mounting screws.
3. Secure the top loop to the threaded pipe.
4. Connect the chain:
  - Determine length of chain needed to achieve desired fixture height. (To remove excess chain section, use pliers to bend link open.)
  - Weave the fixture wires and fixture grounding wire through the chain, collar and canopy.
5. Connect one end of the chain to the loop using a loop lock.
6. Connect the other end of the chain to top loop by using the other loop lock.
7. Thread the fixture wire and fixture grounding wire through the top loop, threaded pipe and mounting strap.

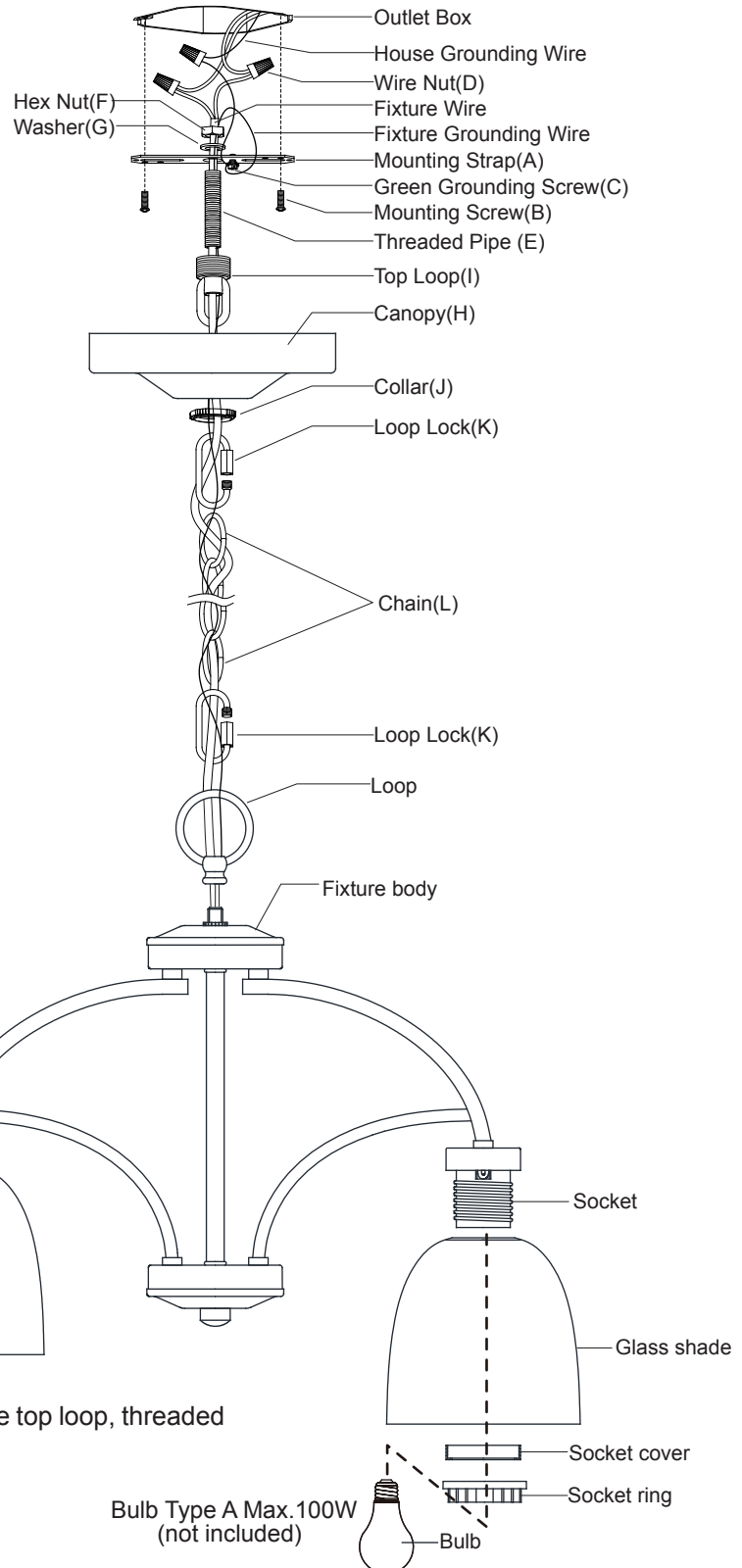











8. Pull out the source wires from the outlet box. Make wire connections using wire nuts as follows:
  - Connect the smooth-coated wire (marked) from the fixture to the black wire from the power source.
  - Connect the ribbed-coated wire (unmarked) from the fixture to the white wire from the power source.
  - Attach the fixture grounding wire to the mounting strap with the green grounding screw, and then connect it to the house grounding wire with a wire nut.
 Carefully put the wires back into the outlet box.
9. Attach the canopy to the mounting strap by inserting the top loop, and then secure it with the collar.
10. Adjust the arms and allow the angle between the three arms is the same.
11. Attach the glass shade onto the socket and attach the socket cover onto the socket. Then tighten them with the socket ring.
 

Note: Make sure the opening side of the socket cover facing up.
12. Install the bulbs (not included). Check relamping label at socket area or packaging for maximum allowed wattage.

**Turn on the power at fuse or circuit box**

The following parts are available for re-order if damaged or missing.

**Spare Parts List:**

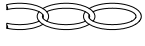
 Mounting Strap (A)	 Mounting Screw (B)	 Green Grounding Screw (C)	 Wire Nut (D)	 threaded pipe (E)	 Hex Nut (F)
 Washer (G)	 Canopy (H)	 Top Loop (I)	 Collar (J)	 Loop Lock (K)	 Chain (L)

Mounting Hardware  
5612MM (1 SET)

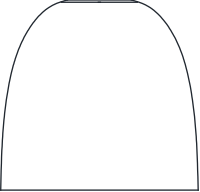

Glass Shade  
9846EW

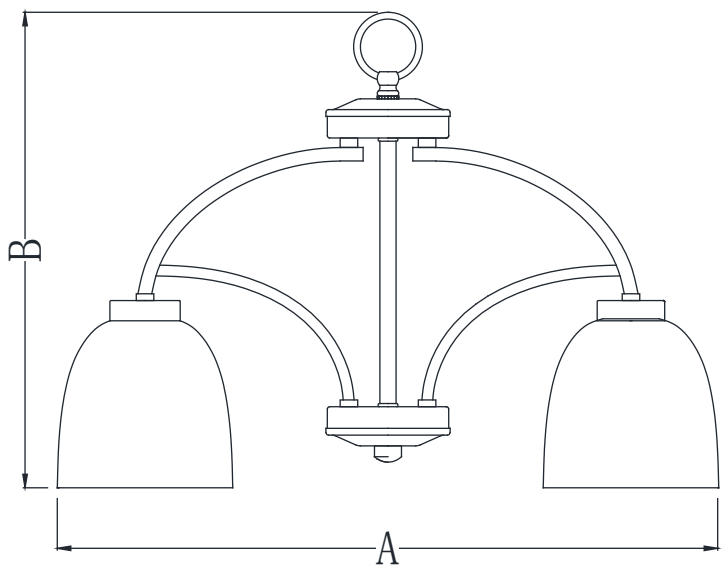

A: 19"  
B: 14"