

TV STAND-N724P426846

Assembly Instructions - Please keep for future reference.

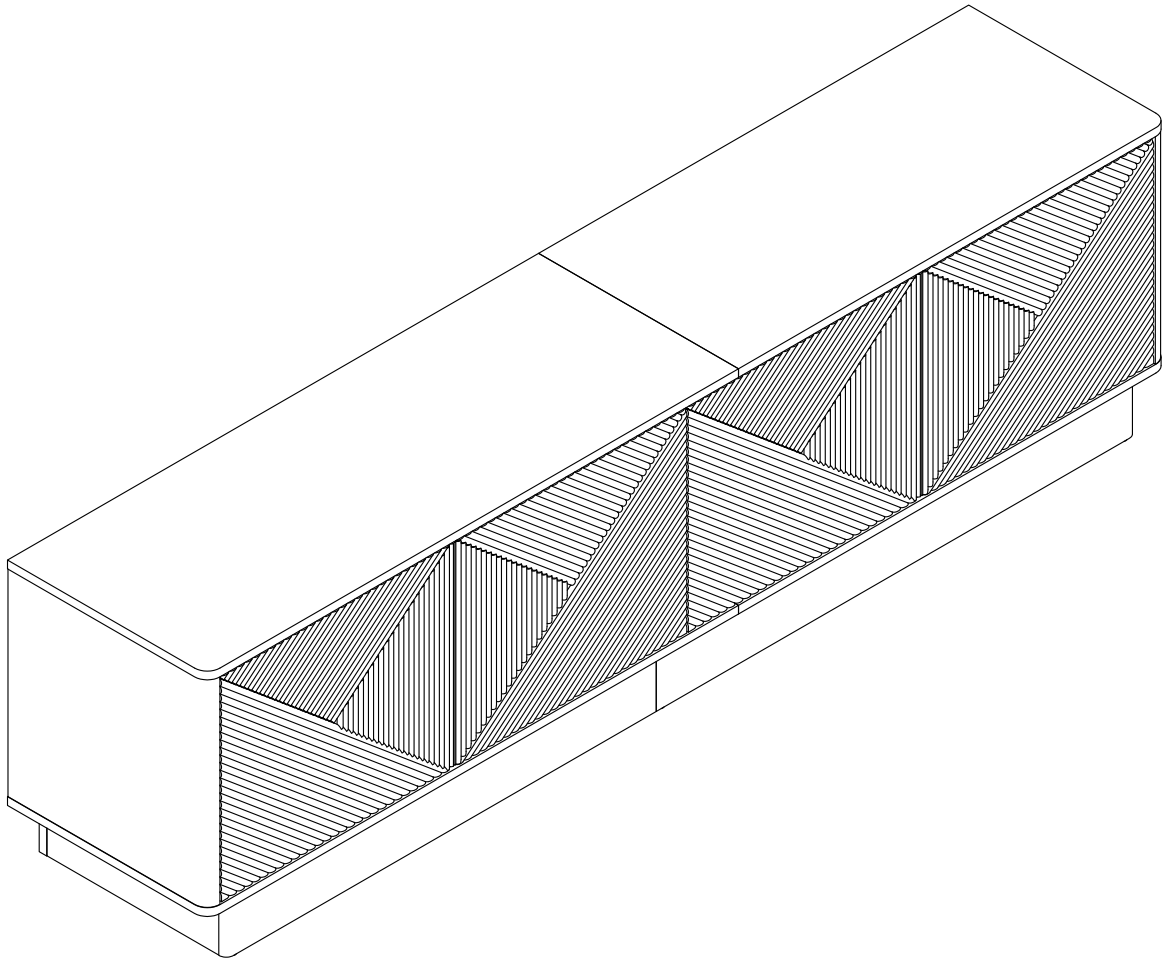

DIMENSIONS

width - 74.80inch

Depth - 15.55inch

Height - 20.47inch

Important - Please read these instructions fully before starting assembly.

Thank you for choosing *our products*.

1. Return Policy



DO NOT RETURN TO THE STORE! Skip the process of returning your product and contact us directly for a replacement

If you find that parts of your order are missing or damaged, we will gladly ship any needed replacement parts free of charge.

If you have found any sort of defect, please contact our customer service department and let us know the details of your order and any issues encountered, we will try our best to provide you with a solution.

Recommendations Before Beginning Assembly



- Read instructions, cover to cover



- Have 2-4 adults on hand for assembly depending on product size



- Do not assemble directly on flooring or carpet



- Assemble on a clean non-marring surface (example: packing foam)























- Save all packaging until finished

3. Assembly Notice:

- If you encounter any problems during assembly and find that you cannot continue, rest assured we will help you solve the situation as soon as possible. Simply keep all of the parts of the product stored in a safe place and contact us immediately so we may assist you further.
- Once you have opened your package, remove all inner hardware packages and take the parts out. One by one, Place the parts out neatly in front of you, then refer to the instructions to ensure no parts are missing. If any pieces are found missing, please carefully look in the box first, as the hardware packaging might have torn making the hardware spill in the box.
- Some key parts of your product may be stored and hidden inside of other parts. Please open any zippered or hook & loop storage compartments to remove all parts. (example: cushions and legs being stored in the underside of a sofa)
- IMPORTANT: When setting up your product, DO NOT INSTALL THE SCREWS ALL THE WAY IN THE BEGINNING. Place each screw into their proper hole and use your hand to twist the screw halfway. Twist all the screws in halfway to ensure the holes will match up properly and the product is level on the ground. When everything seems fitted, then tighten the screws.
- When you have completed assembly, we suggest you have more than one person to assist you with lifting and placing the product.

Care & Maintenance

-   ● Do not put hot items directly on furniture surface
-   ● Do not clean furniture with harsh cleansers or polish
-   ● Do not place furniture under direct sunlight
-   ● Do not place furniture near heating or cooling vents
-   ● Do not write on furniture without a padded barrier to protect the surface
-   ● Do not place furniture outside. For indoor use only
-   ● Not for commercial use. For residential use only
-   ● Stains may be removed with mild soap solution and damp cloth
-   ● Children should not climb or jump on the furniture
-   ● Dust and pick-up spills using a clean, non-colored, lint-free cloth

Caution

- This product contains small components. Please ensure that they are kept away from small children.
- Do not use power tools to assemble your furniture. Power tools may strip or damage the parts.

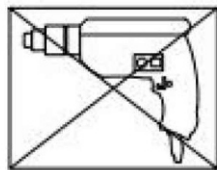

components - fittings

Please check you have all the panels listed below.

Note: The quantities below are the correct amount to complete the assembly. In some cases more fittings may be supplied than are required.

N724P426846

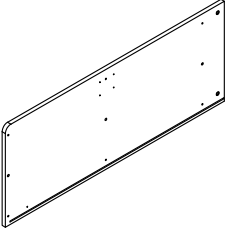
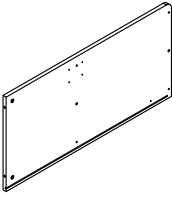
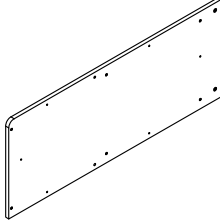
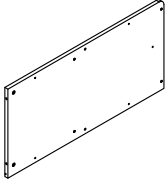
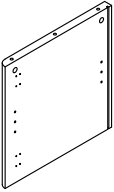
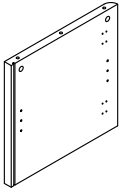
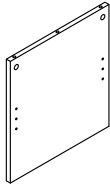
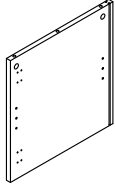
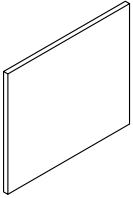
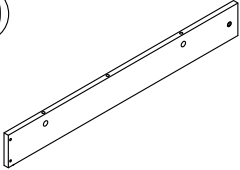
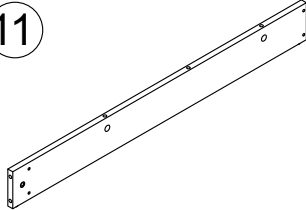
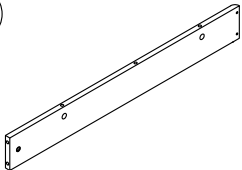
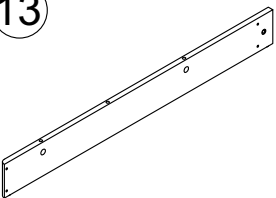
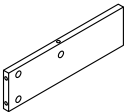
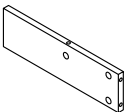
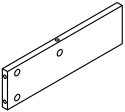
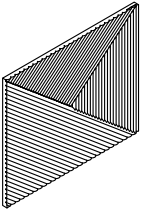
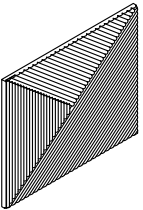
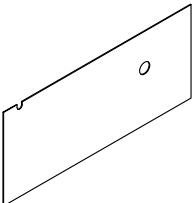









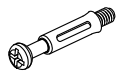
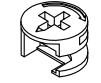

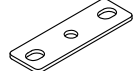
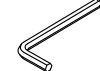
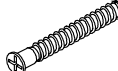

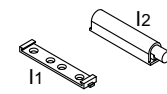
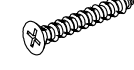
			
1PC	1PC	1PC	1PC
			
1PC	1PC	2PCS	1PC
			
4PCS	1PC	1PC	1PC
			
1PC	1PC	1PC	1PC
			
2PCS	2PCS	2PCS	

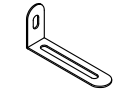
components - fittings

Please check you have all the panels listed below.

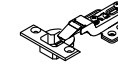
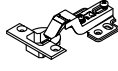
Note: The quantities below are the correct amount to complete the assembly. In some cases more fittings may be supplied than are required.

Hardware-Liste :N724P426846

A	X27	B	X27	C	X56	D	X6	E	X1	F	X16
											
M6x35mm				M3.5x14mm				4mm		M5x40mm	
G	X22	H	X12	I	X4	J	X2	K	X2	M	X2
											
		M6x12mm				M4x35mm					
N	X2	O	X16	P	X12	Q	X12	R	X4	S	X4
											
M4x12mm						M3x16mm					
T	X4	U	X4	V	X1						
											
M3x12mm											

Assembly Instructions

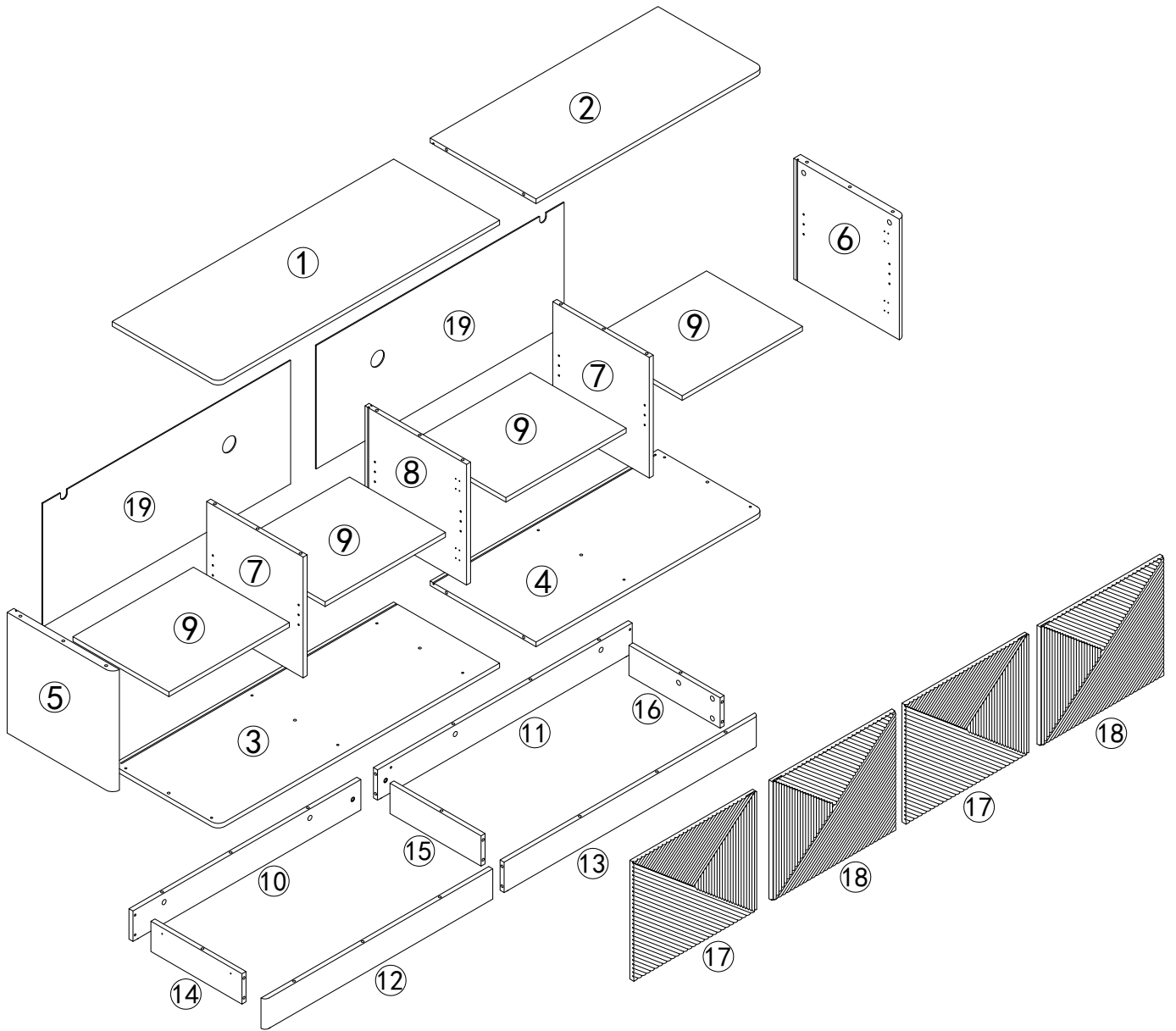

HINGE INSTRUCTIONS

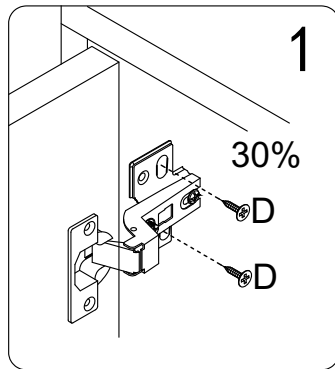

Tighten the screws only 30% as long as the door can be secured.

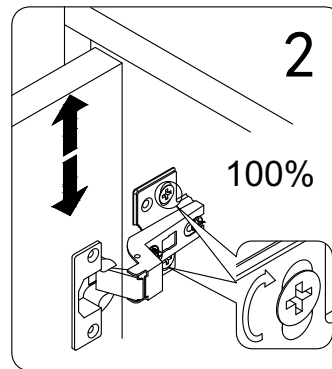

Move the door up and down until it is centred, then tighten the screw 100%.

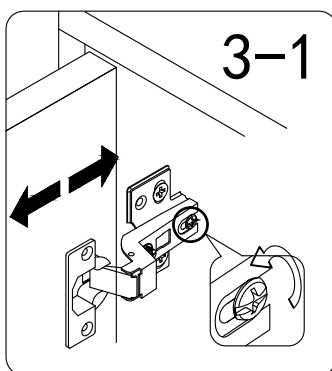

Loosen the screw **anti-clockwise**, and move the door **in or out** until it's aligned to side board.

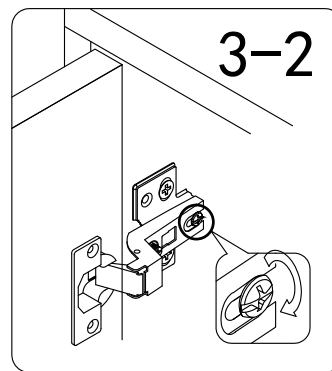

Tighten the screw **clockwise** once the door is **aligned**.

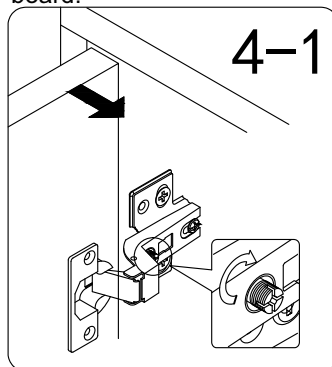

To adjust the gap between the door and the side board to be **larger**, turn the screw **clockwise**.

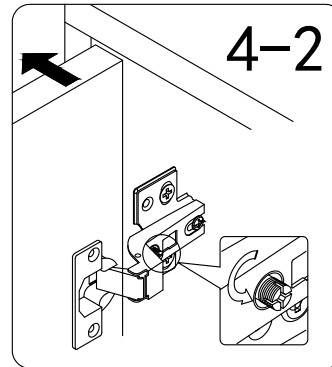

To adjust the gap between the door and the side board to be **smaller**, turn the screw **anti-clockwise**.

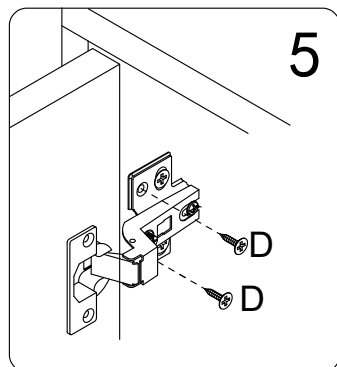

After adjusting the doors properly above, finally tighten these two screws and secured the door.

Assembly Instructions

Step 1

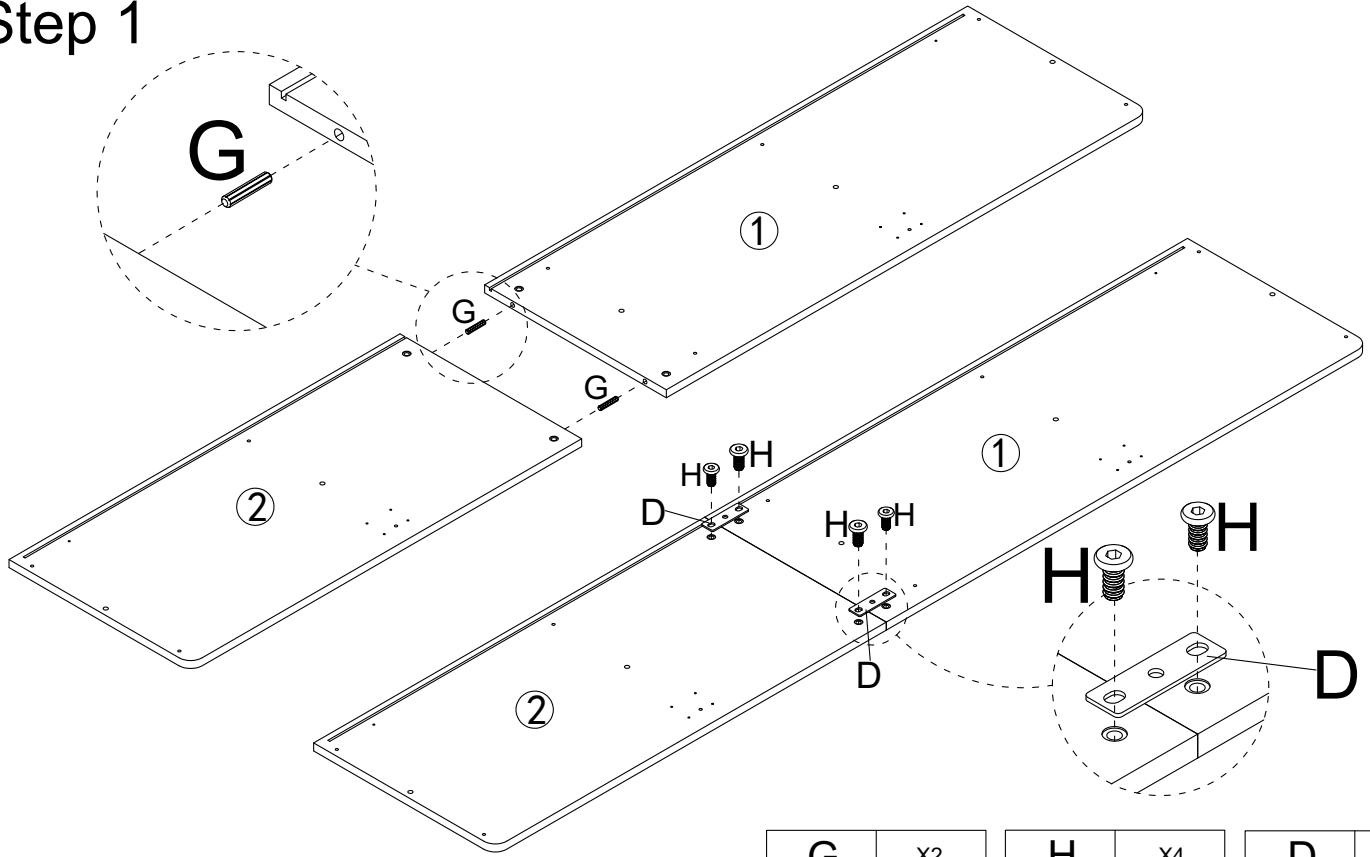

G	X2	H	X4	D	X2
		M6x12mm			

Step 2

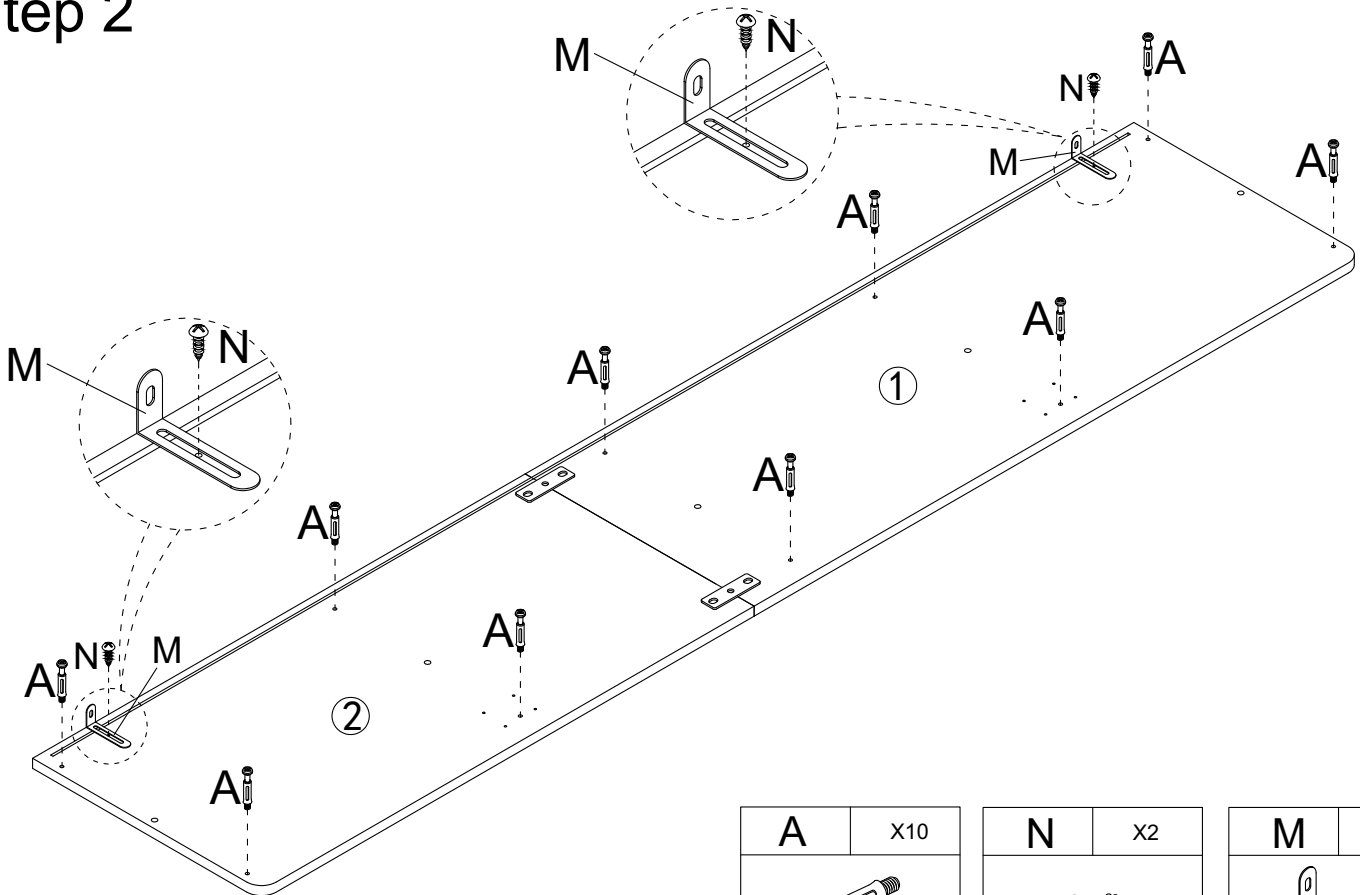

A	X10	N	X2	M	X2
M6x35mm		M4x12mm			

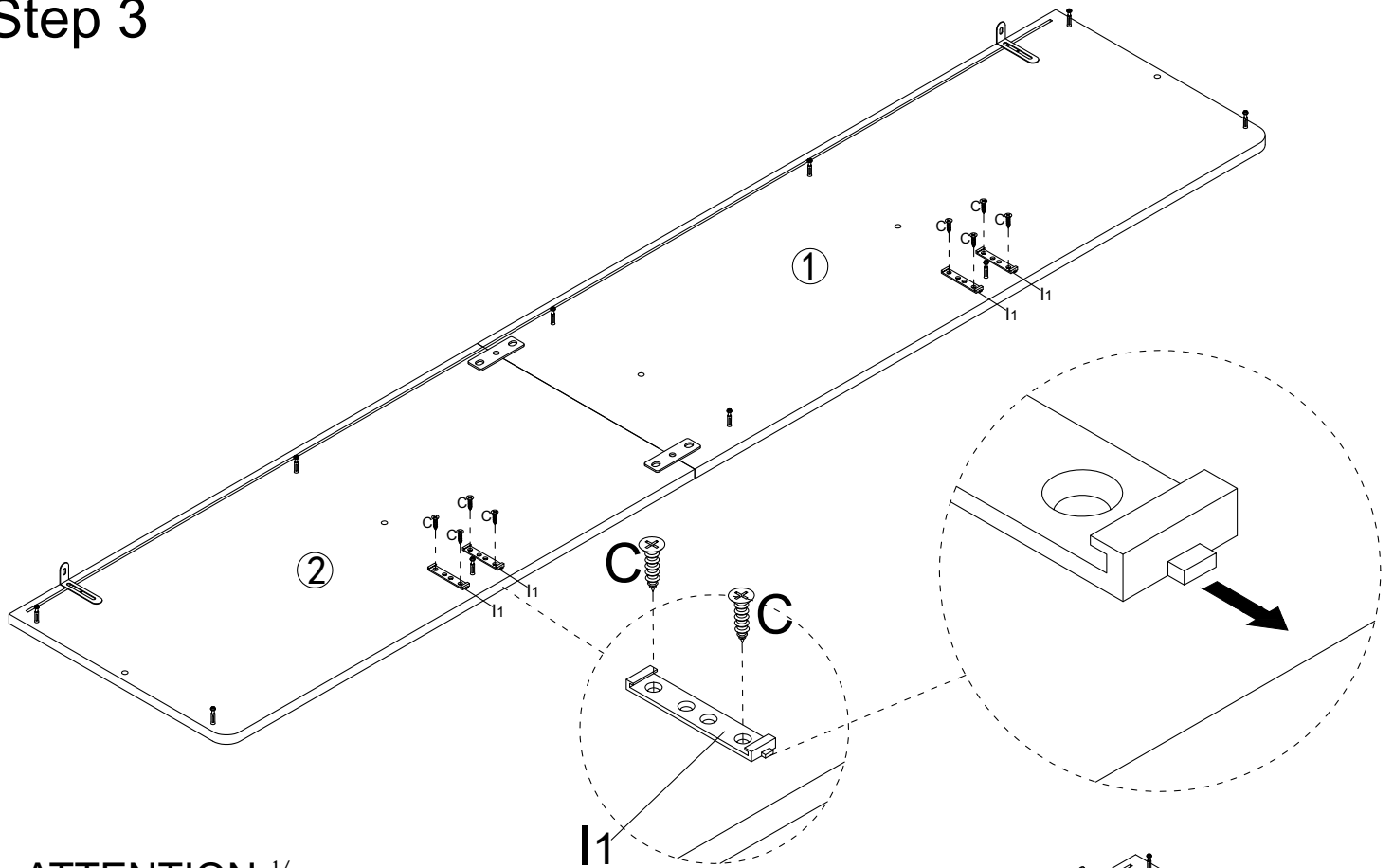

Assembly Instructions

Step 3

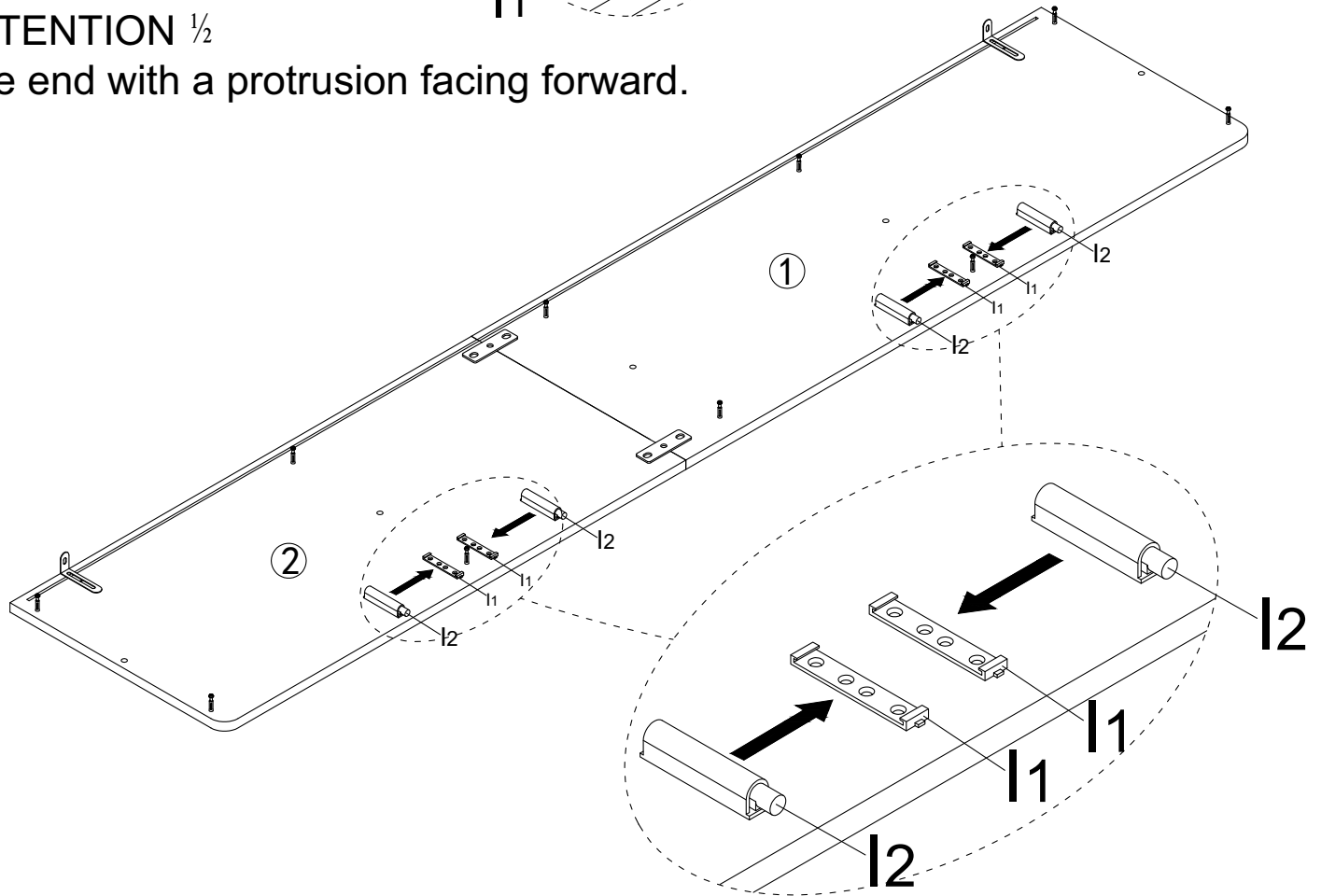

ATTENTION $\frac{1}{2}$
The end with a protrusion facing forward.



C	X8	I	X4
			
M3.5x14mm			

Assembly Instructions

Step 4

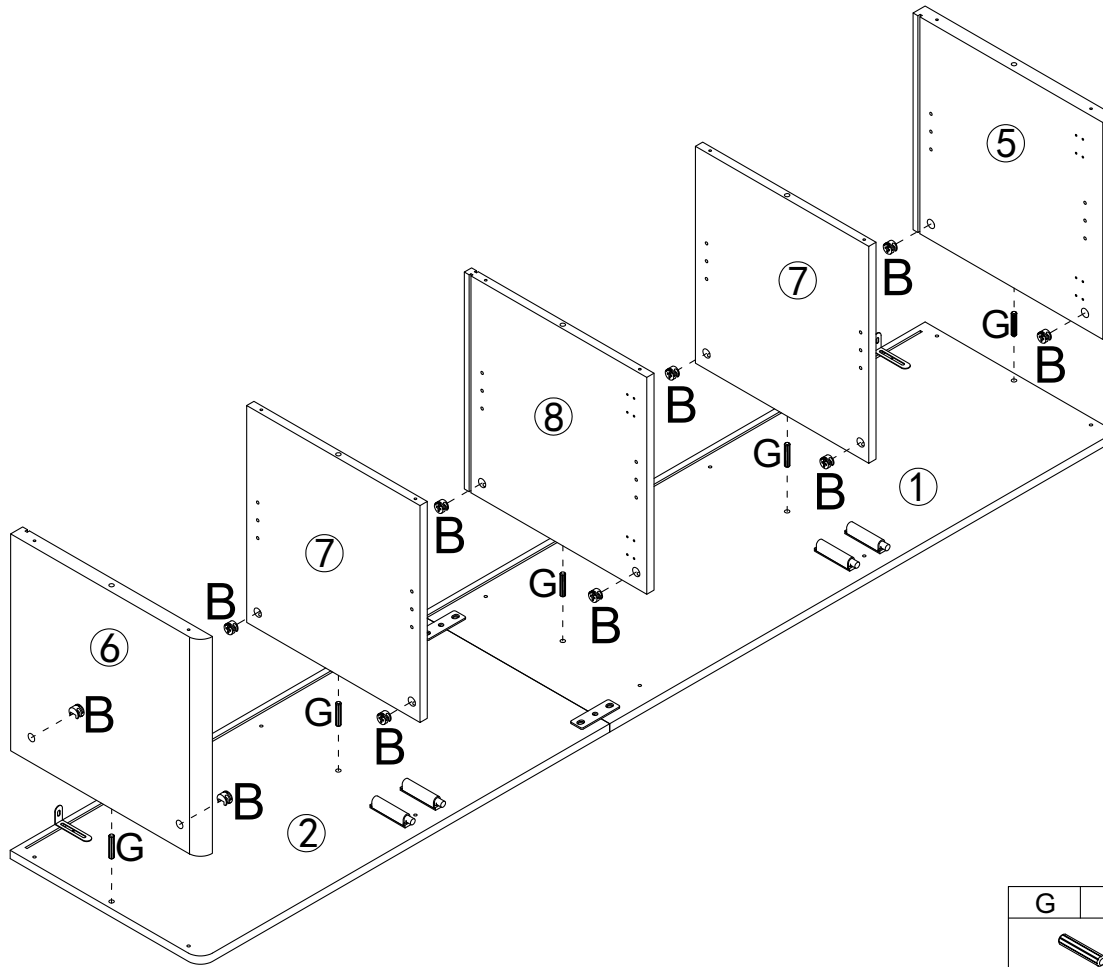

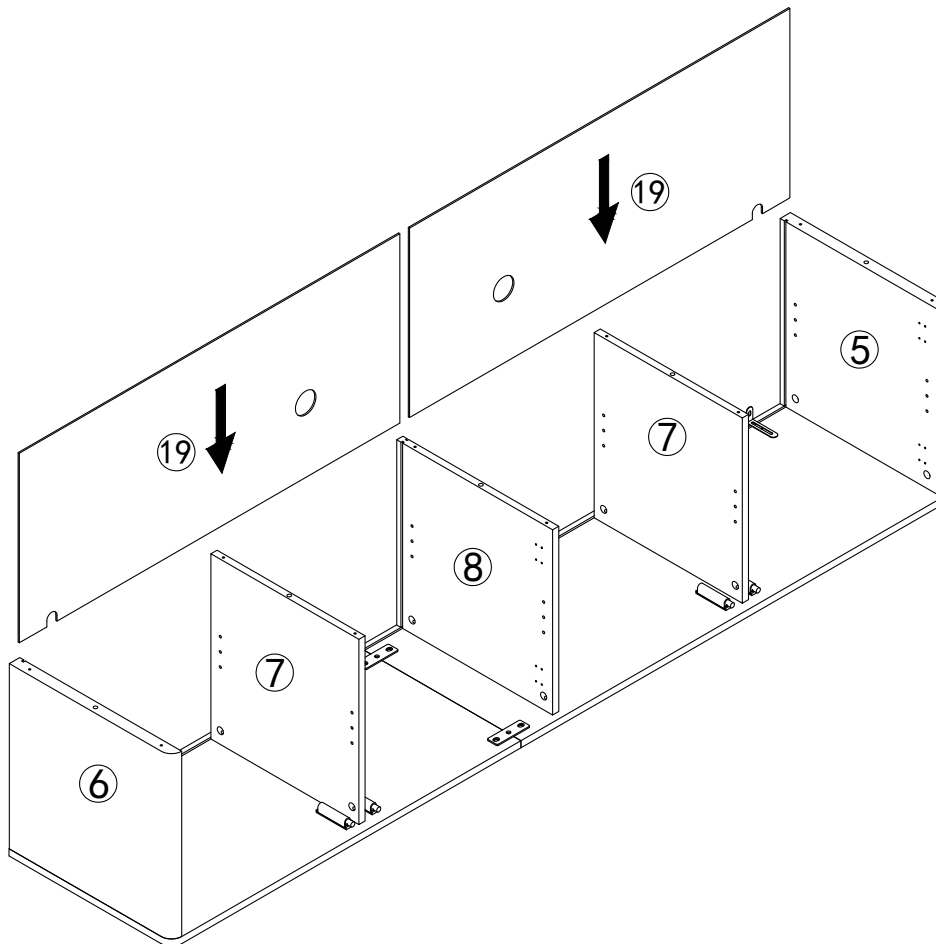

Step 5

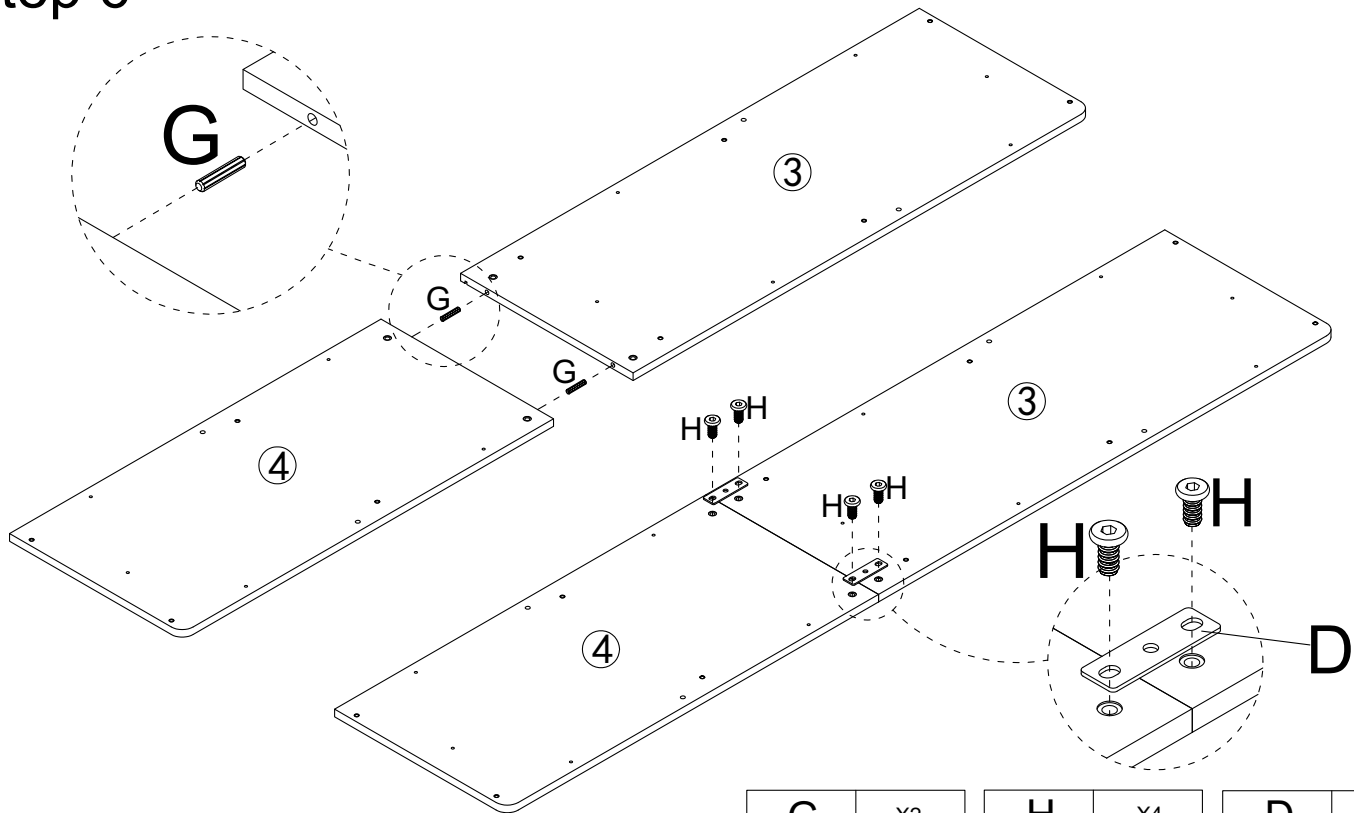

Assembly Instructions

Step 6

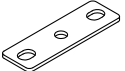

G	X2	H	X4	D	X2
					
		M6x12mm			

Step 7

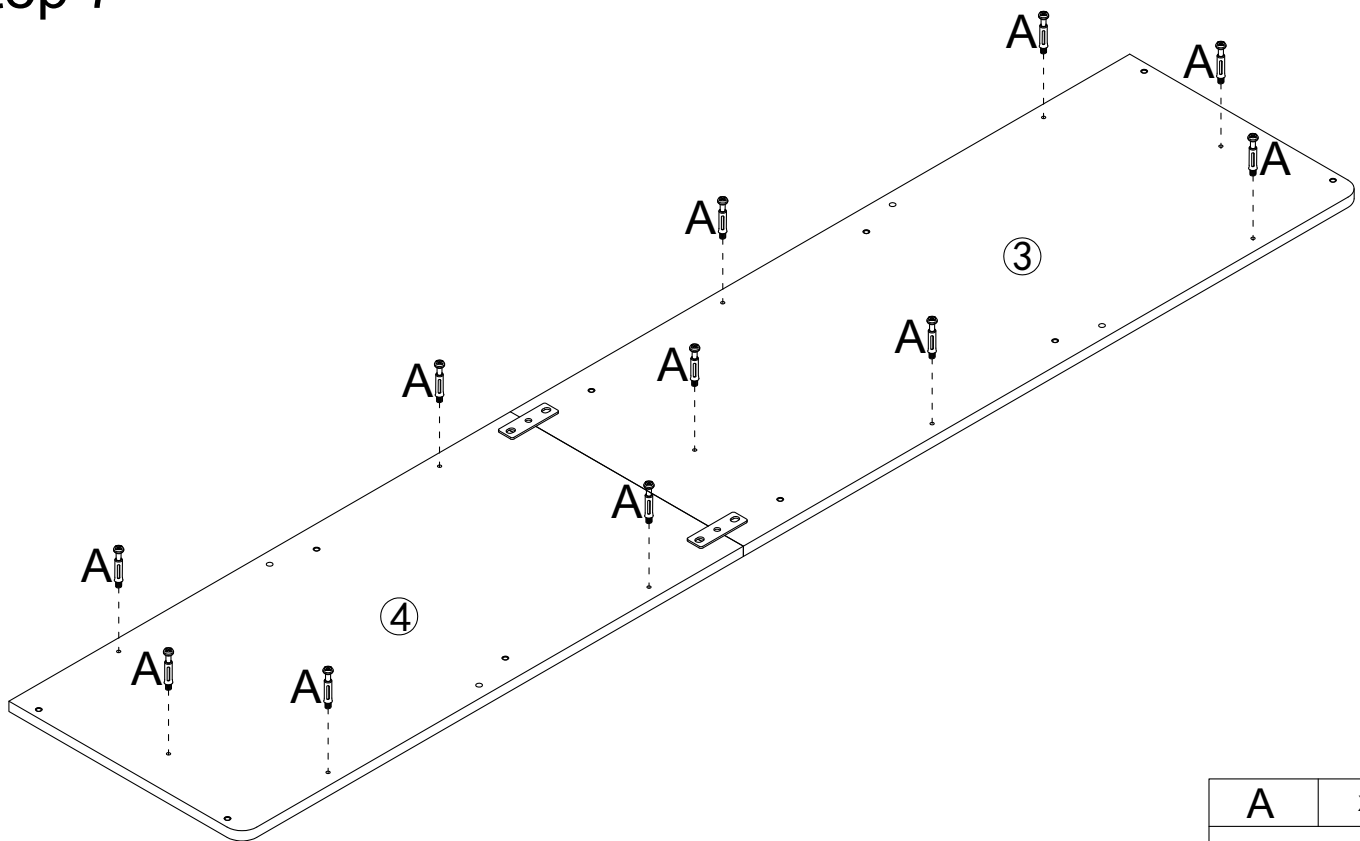



A	X11
	
M6x35mm	

Assembly Instructions

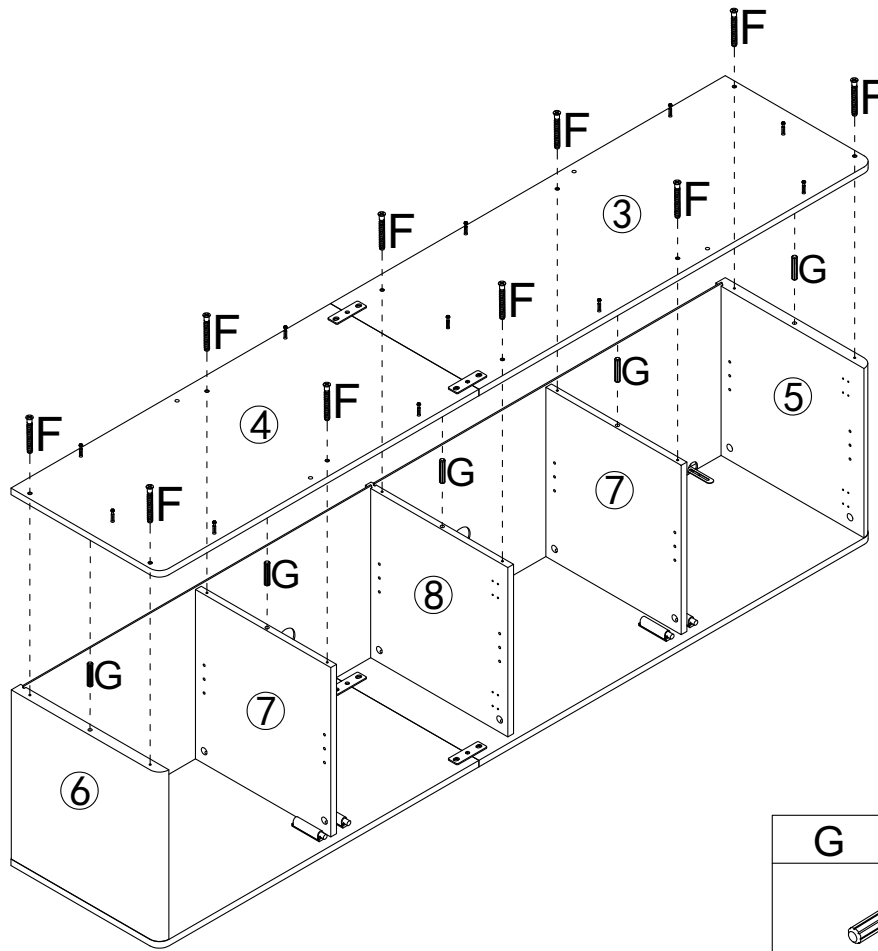

Step 8

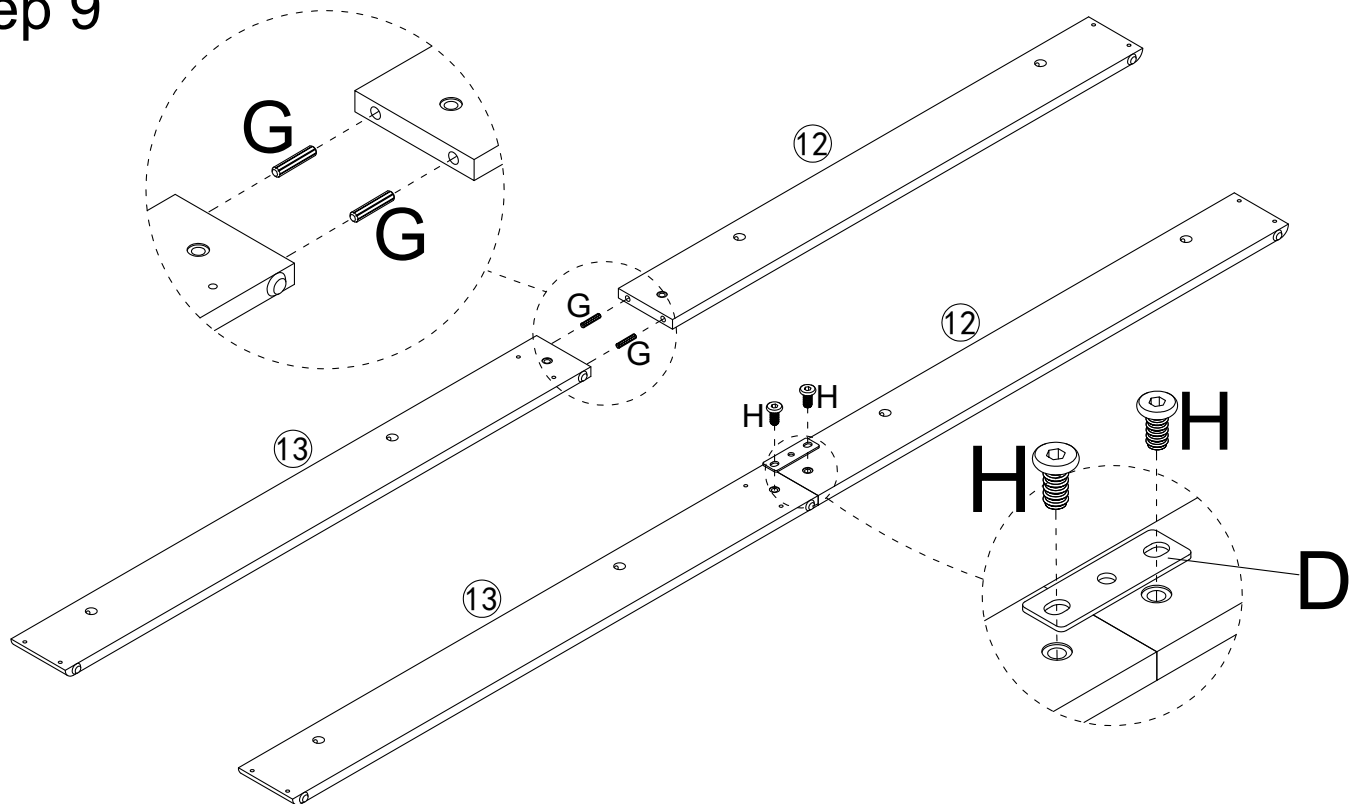

G	X5	F	X10
			
		M5x40mm	

Step 9

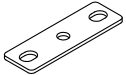

G	X2	H	X2	D	X1
					
		M6x12mm			

Assembly Instructions

Step 10

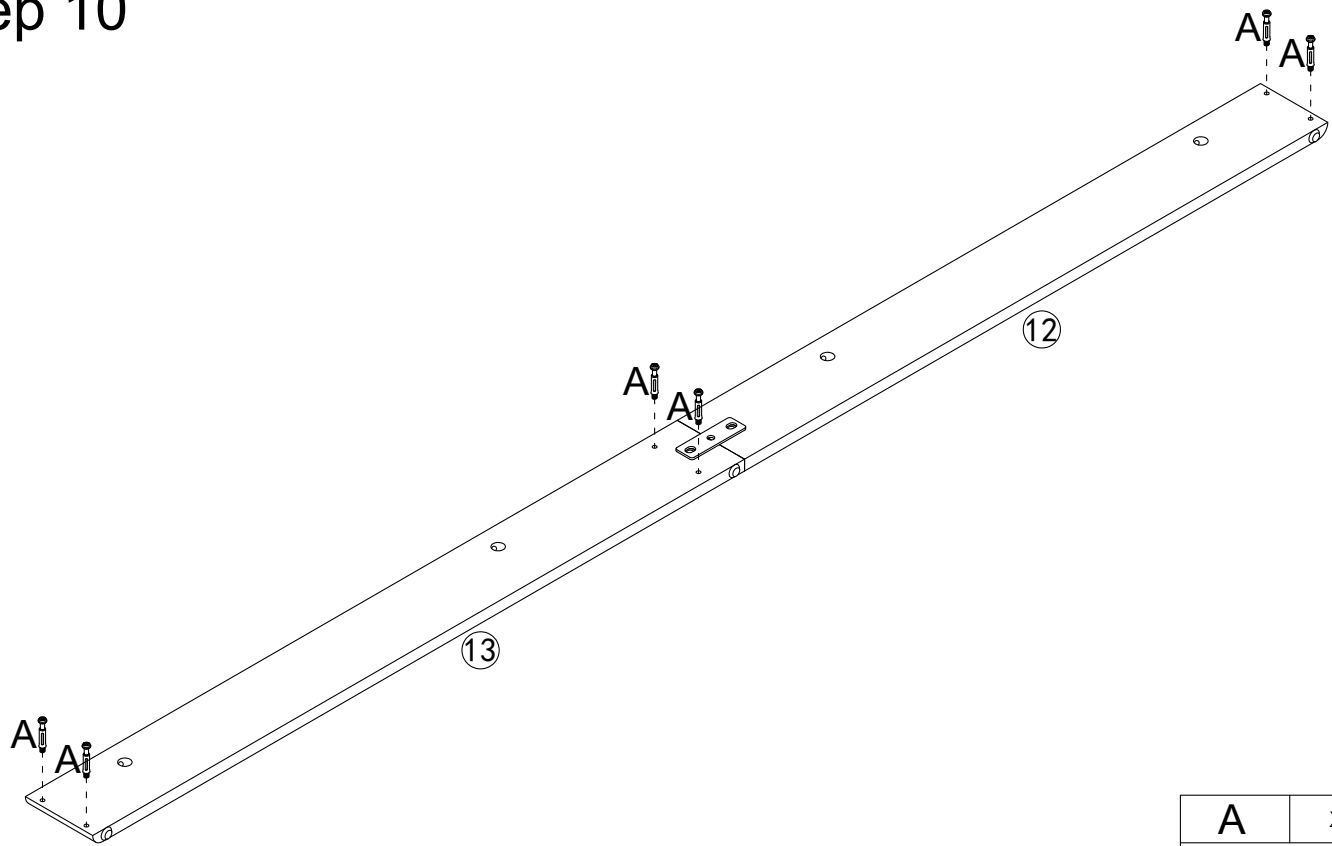

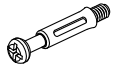
A	X6
	
M6x35mm	

Step 11

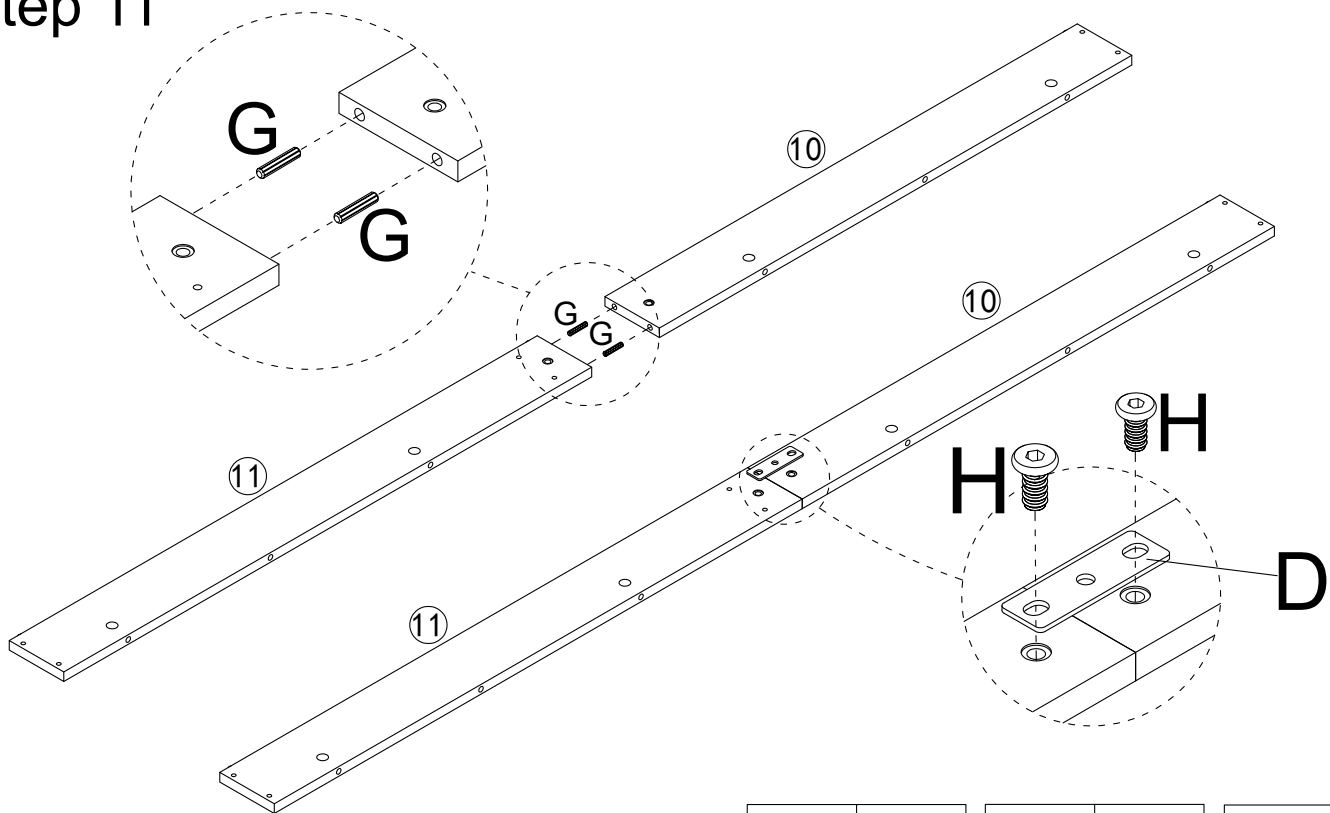

G	X2
	

H	X2
	
M6x12mm	

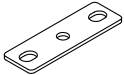
D	X1
	

Assembly Instructions

Step 12

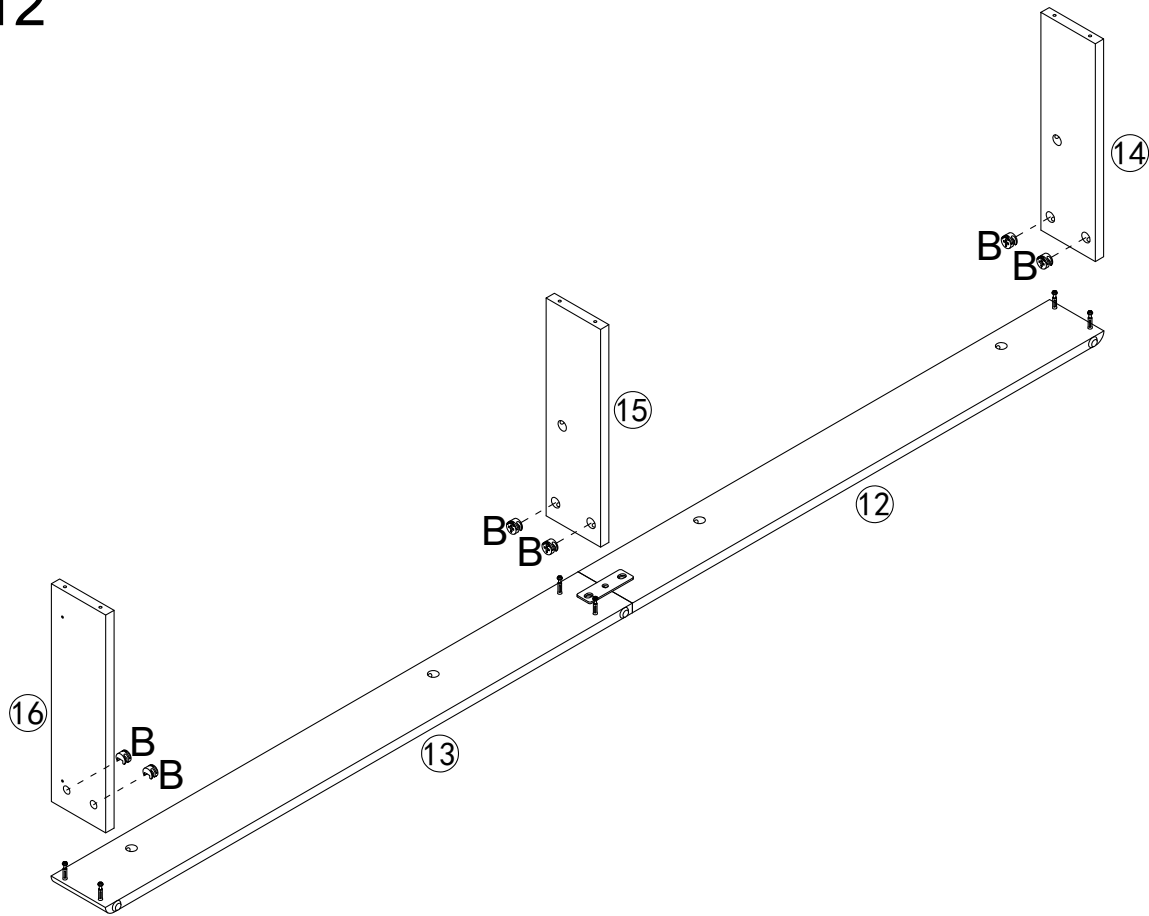

B	X6
	

Step 13

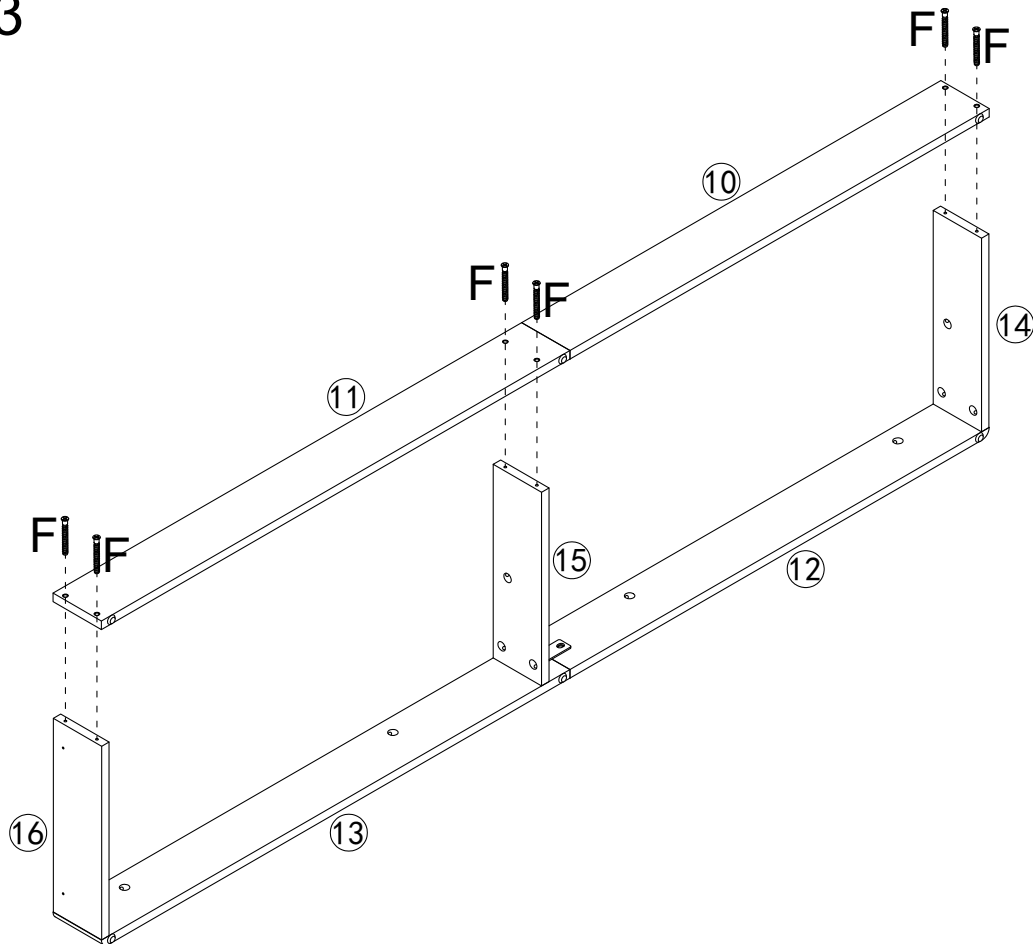

F	X6
	
M5x40mm	

Assembly Instructions

Step 14

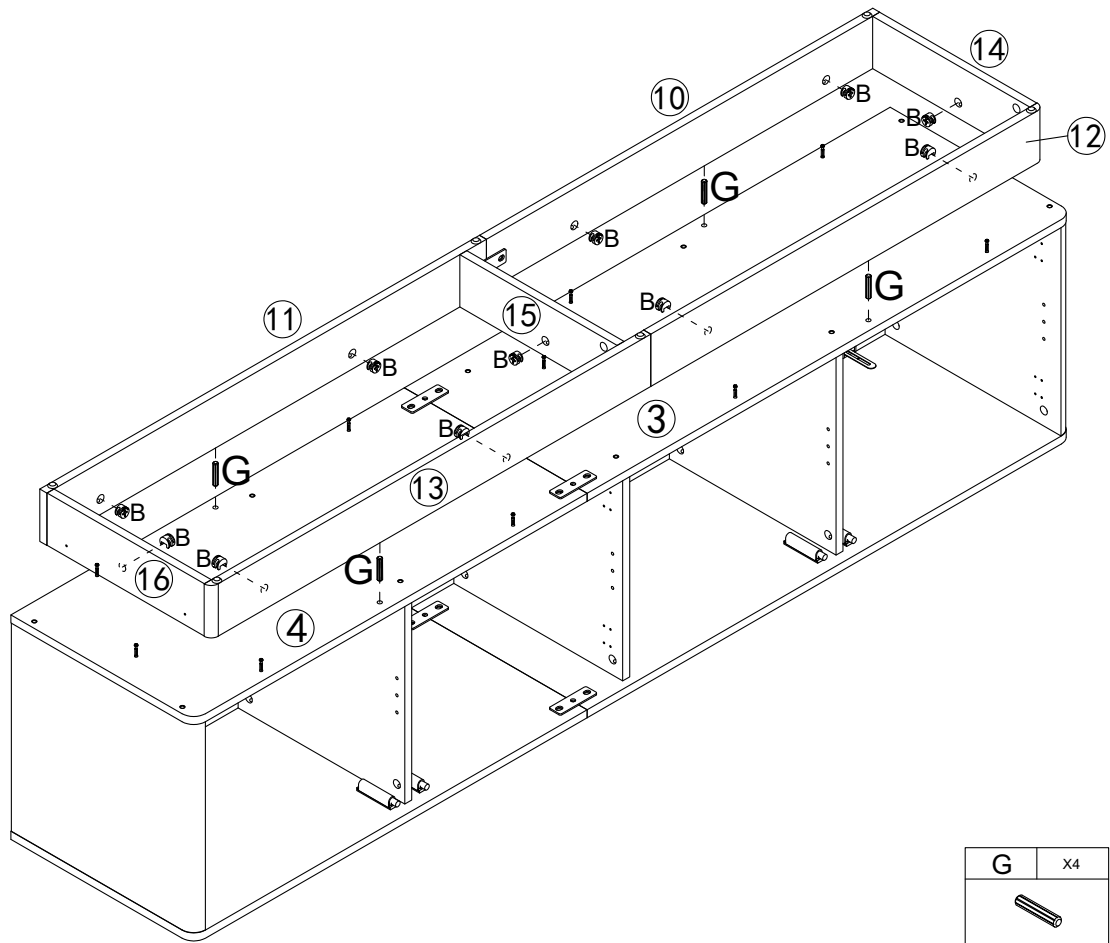

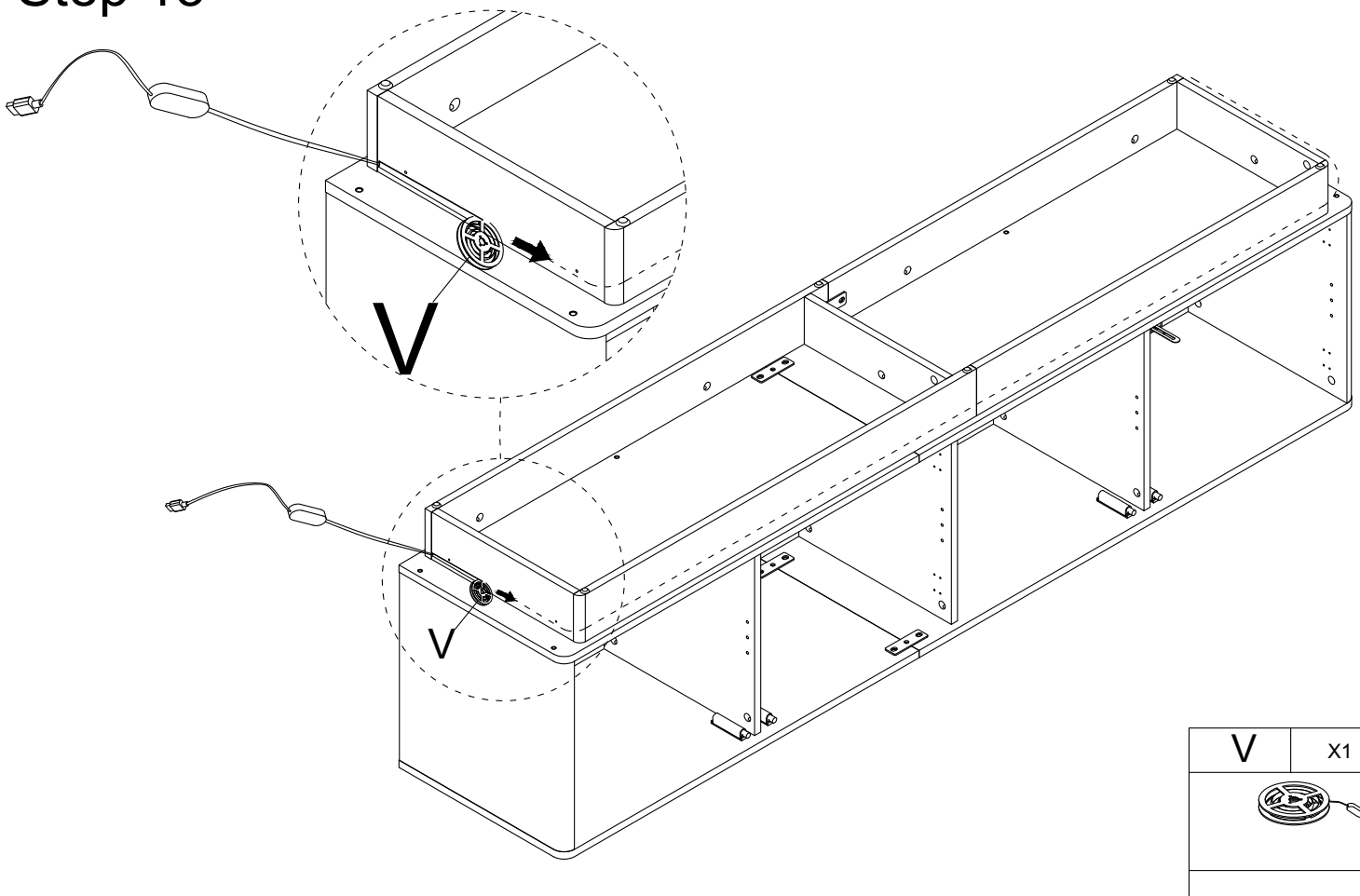

Step 15



Assembly Instructions

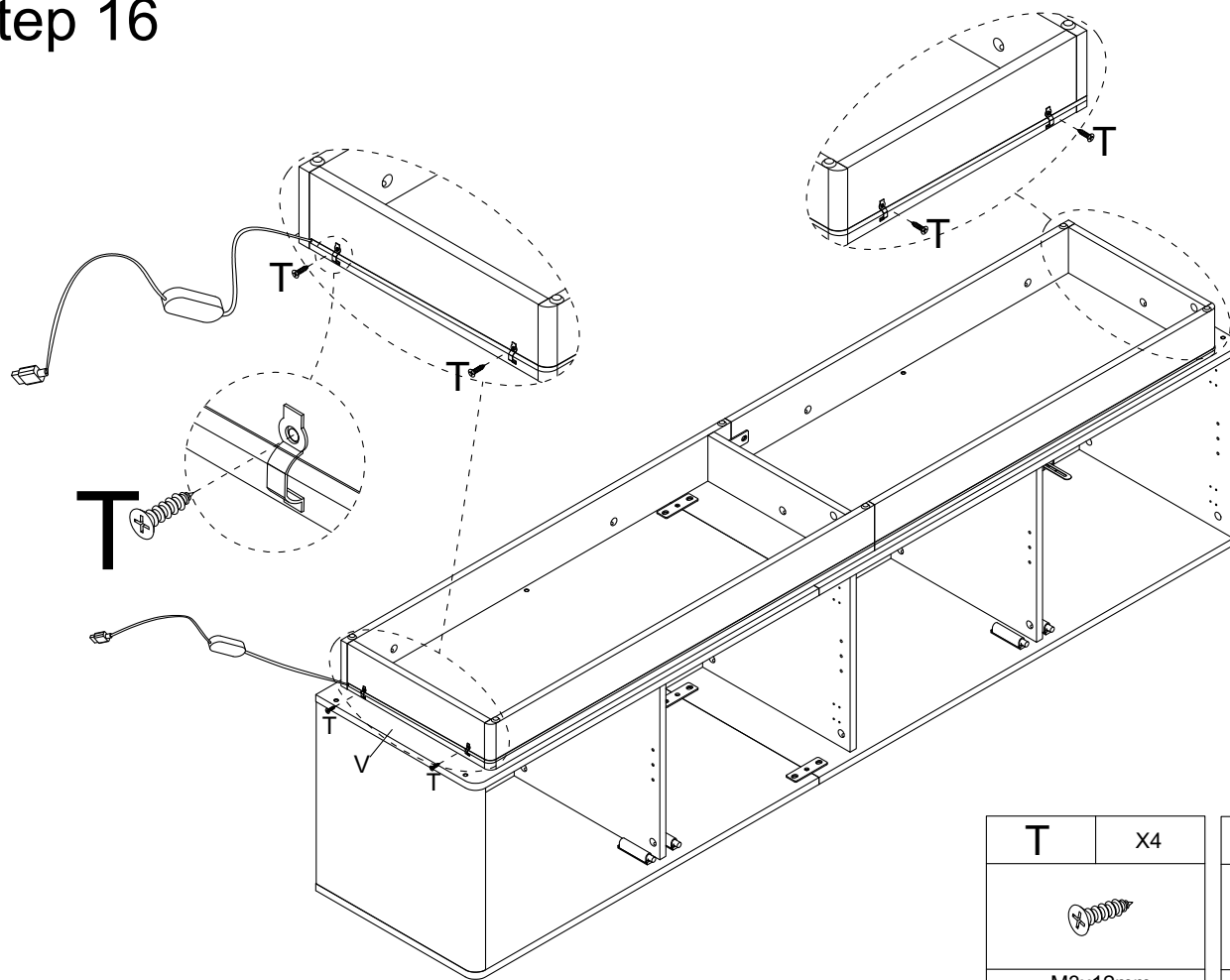

Step 16

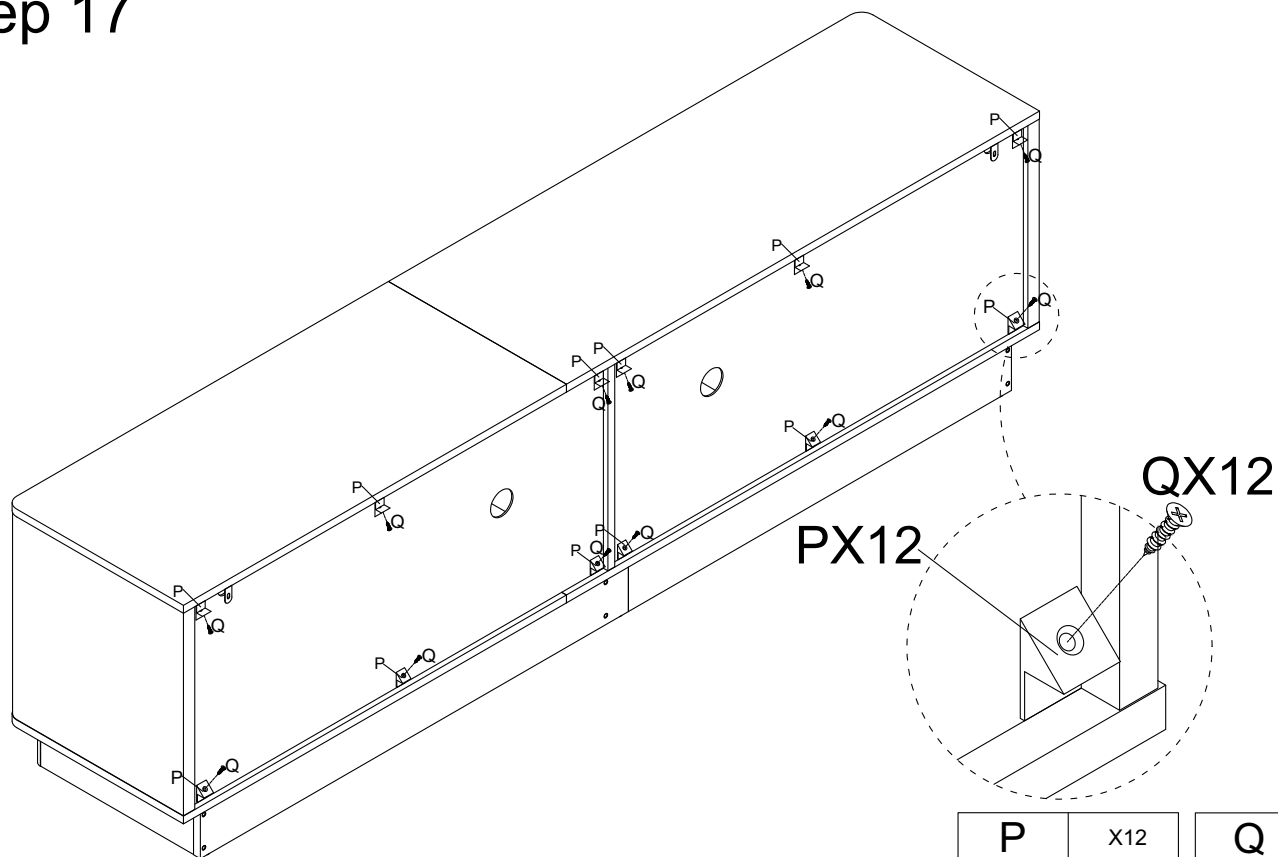

T	X4	U	X4
			
M3x12mm			

Step 17



P	X12	Q	X12
			
		M3x16mm	

Assembly Instructions

Step 18

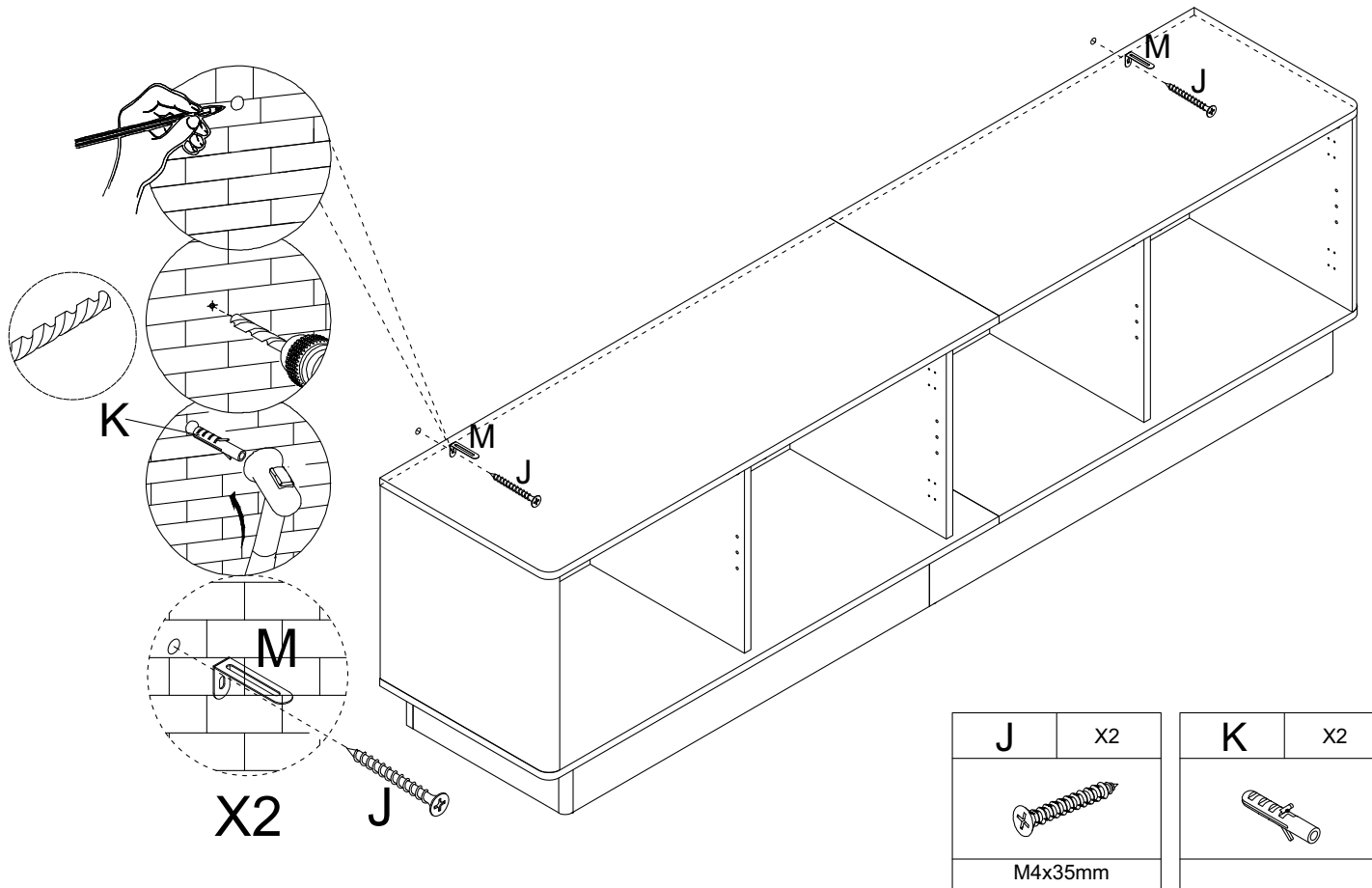

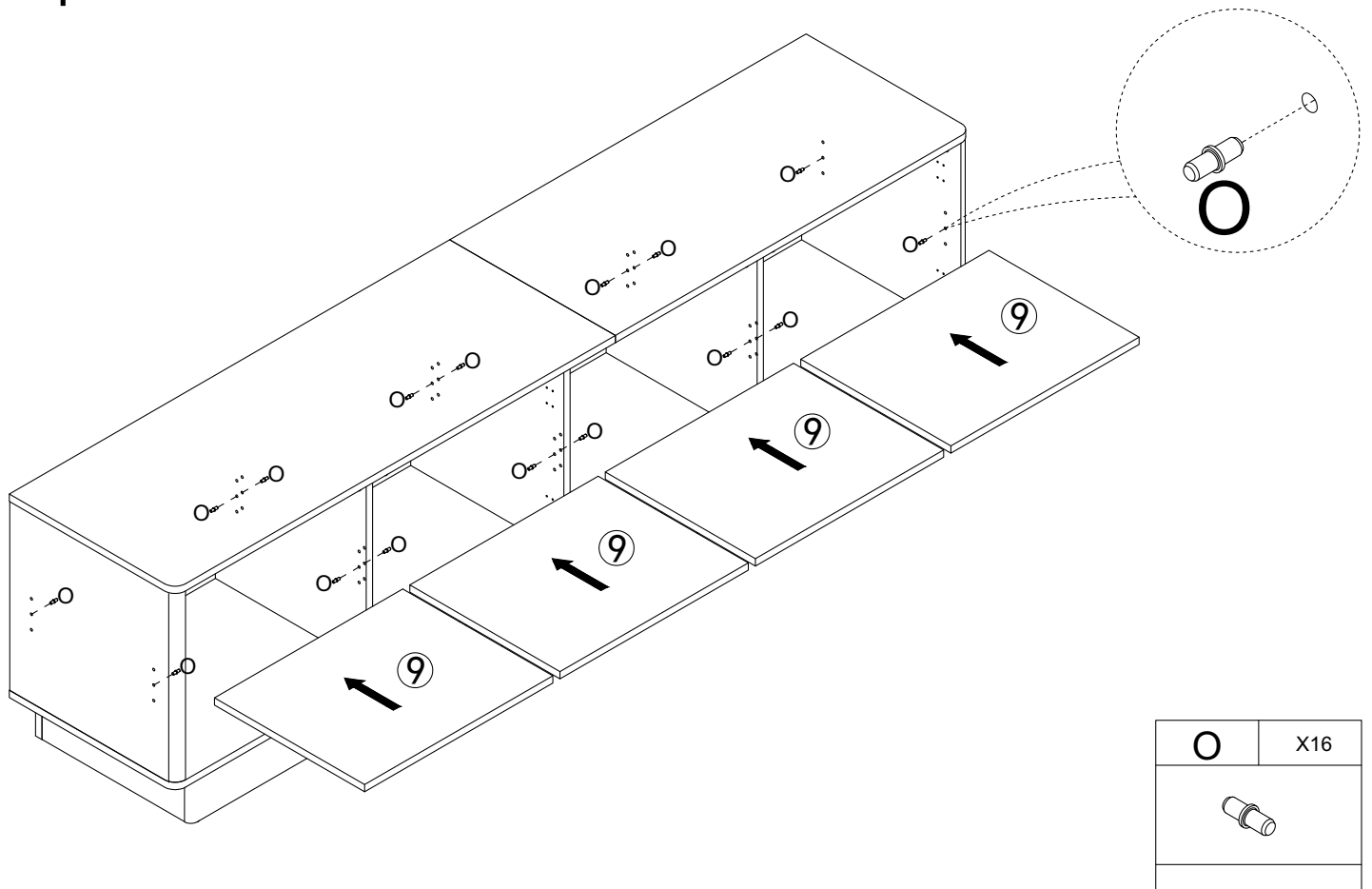

Step 19

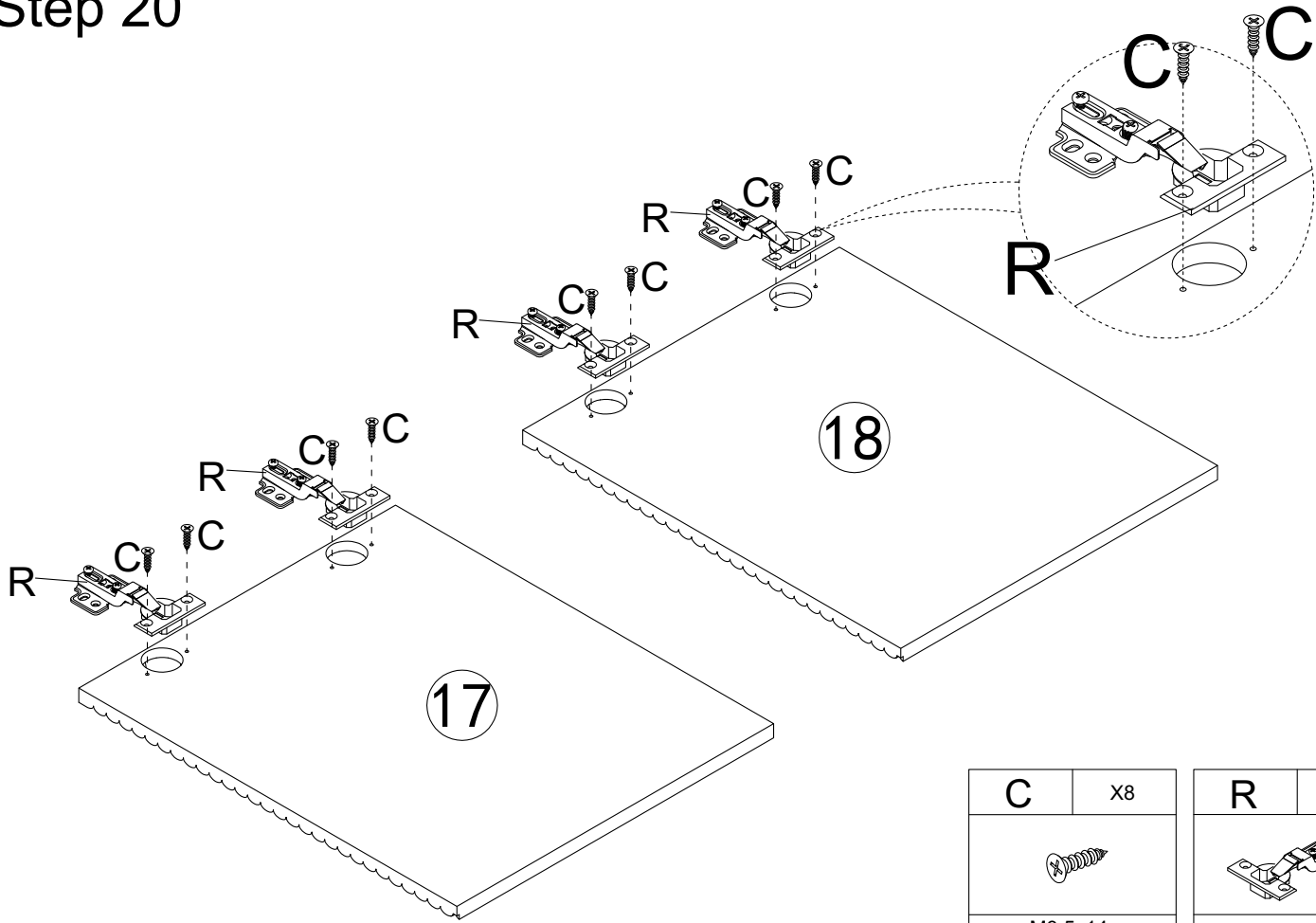

Assembly Instructions

Step 20

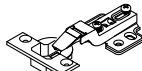

C	X8	R	X4
			
M3.5x14mm			

Step 21

Please install and adjust the hinges strictly in accordance with the detailed steps 1, 2, 3, 4 and 5 to assemble the doors

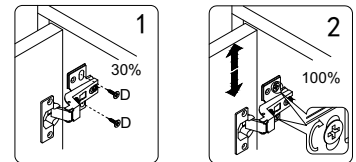
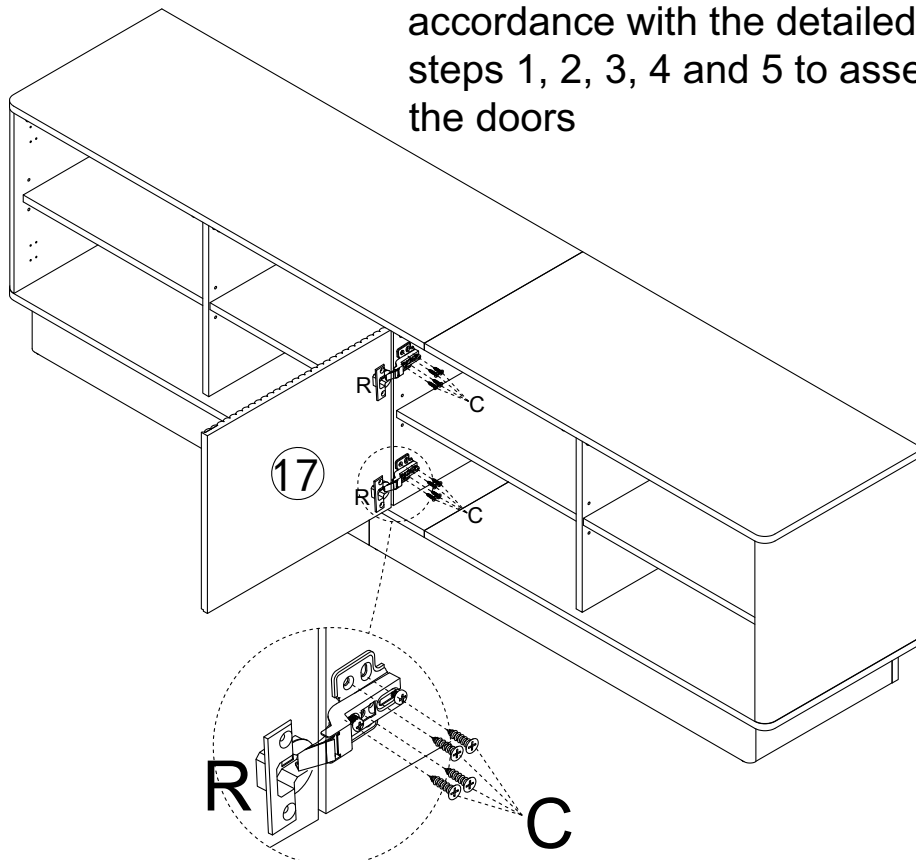

1
Tighten the screws only 30% as long as the door can be secured.

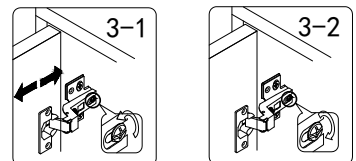

3-1
Loosen the screw **anti-clockwise**, and move the door **in** or **out** until it's aligned to side board.

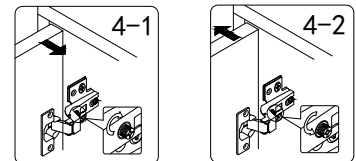

4-1
To adjust the gap between the door and the side board to be **larger**, turn the screw **clockwise**.

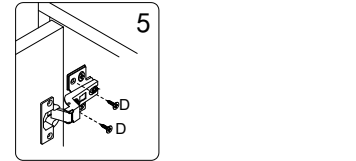

5
After adjusting the doors properly above, finally tighten these two screws and secured the door.

C	X8
	
M3.5x14mm	

Assembly Instructions

Step 22

Please install and adjust the hinges strictly in accordance with the detailed steps 1, 2, 3, 4 and 5 to assemble the doors

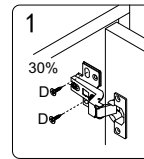
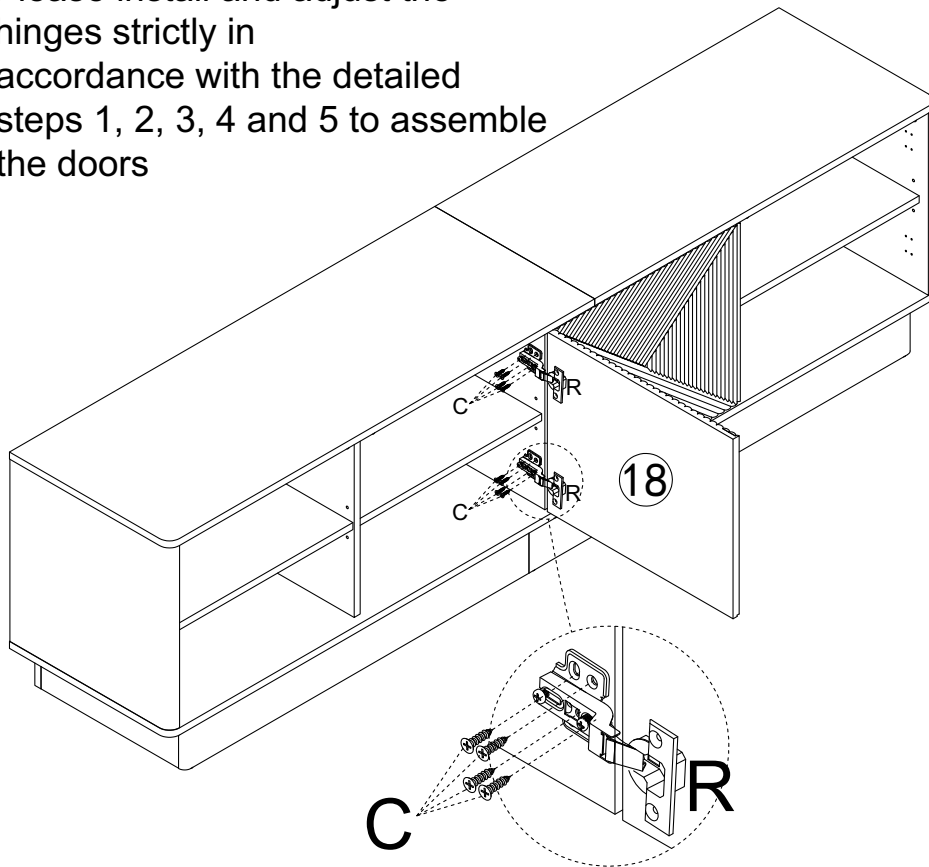

Tighten the screws only 30% as long as the door can be secured.

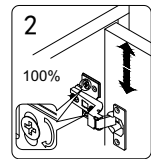

Move the door up and down until it is centred, then tighten the screw 100%.

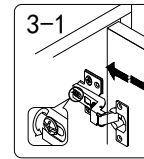

Loosen the screw anti-clockwise and move the door in or out until it's aligned to side board.

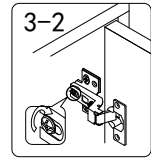

Tighten the screw clockwise once the door is aligned.

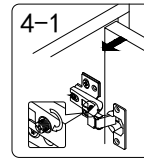

To adjust the gap between the door and the side board to be larger, turn the screw clockwise.

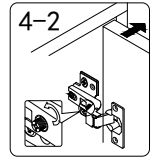

To adjust the gap between the door and the side board to be smaller, turn the screw anti-clockwise.

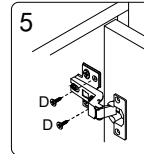

After adjusting the doors properly above, finally tighten these two screws and secured the door.

C	X8
	
M3.5x14mm	

Step 23

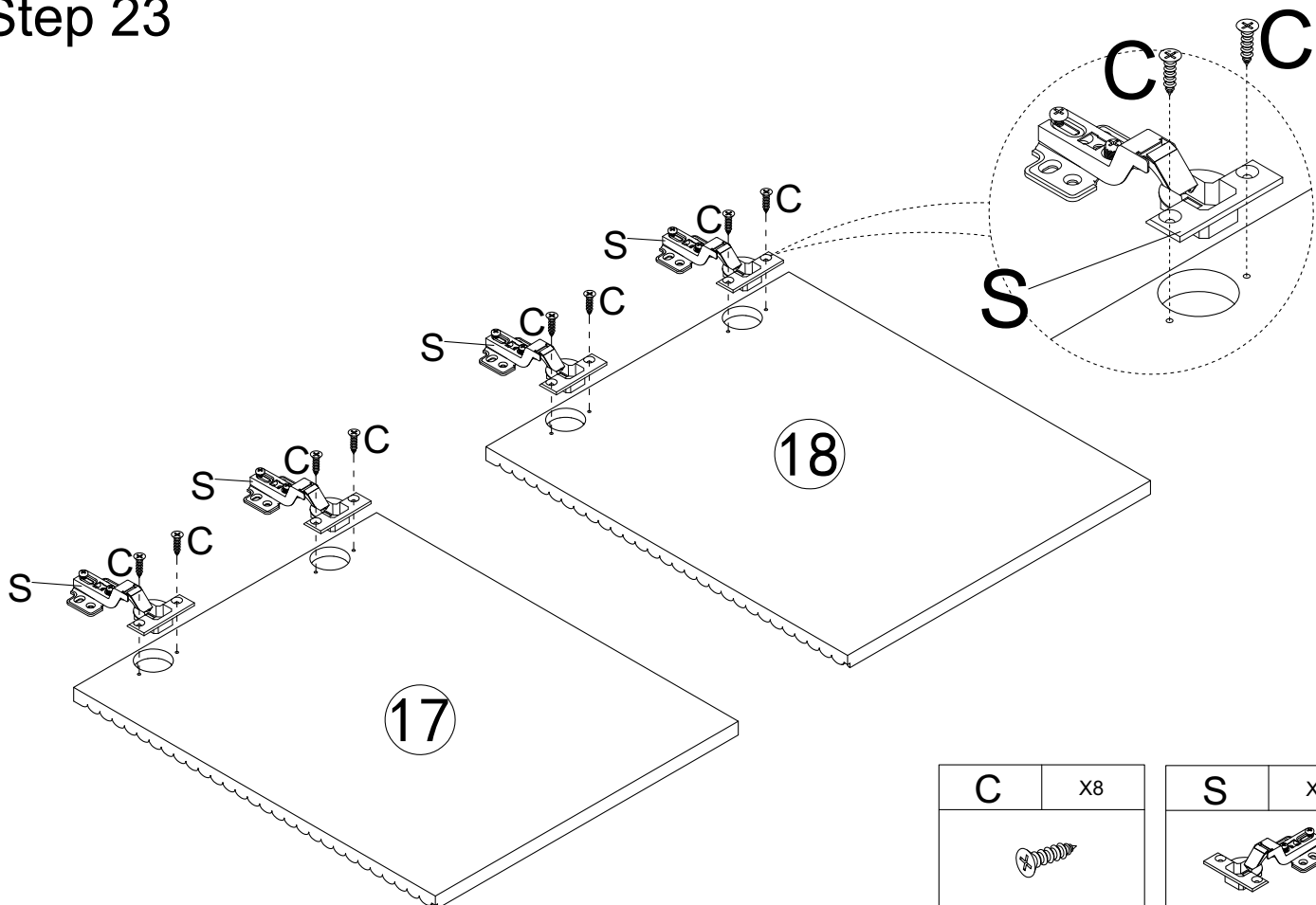

C	X8
	
M3.5x14mm	

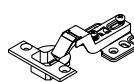
S	X4
	

Assembly Instructions

Step 24

Please install and adjust the hinges strictly in accordance with the detailed steps 1, 2, 3, 4 and 5 to assemble the doors

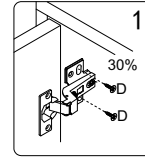
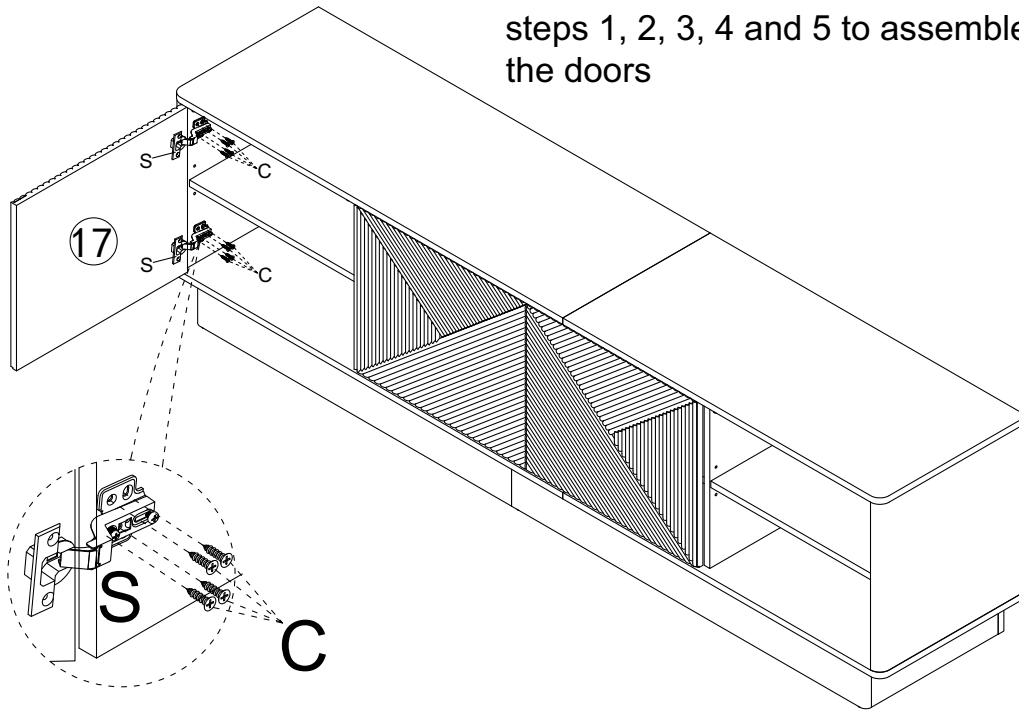

Tighten the screws only 30% as long as the door can be secured.

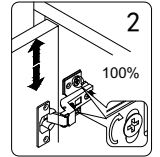

Move the door up and down until it is centred, then tighten the screw 100%.

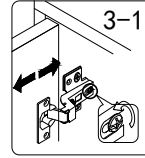

Loosen the screw anti-clockwise, and move the door in or out until it's aligned to side board.

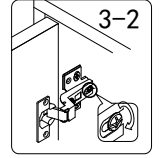

Tighten the screw clockwise once the door is aligned.

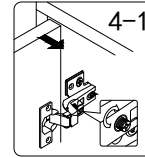

To adjust the gap between the door and the side board to be larger, turn the screw clockwise.

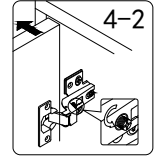

To adjust the gap between the door and the side board to be smaller, turn the screw anti-clockwise.

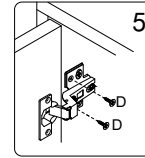

After adjusting the doors properly above, finally tighten these two screws and secured the door.

C	X8
	
M3.5x14mm	

Step 25

Please install and adjust the hinges strictly in accordance with the detailed steps 1, 2, 3, 4 and 5 to assemble the doors

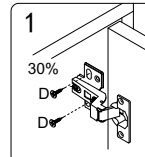
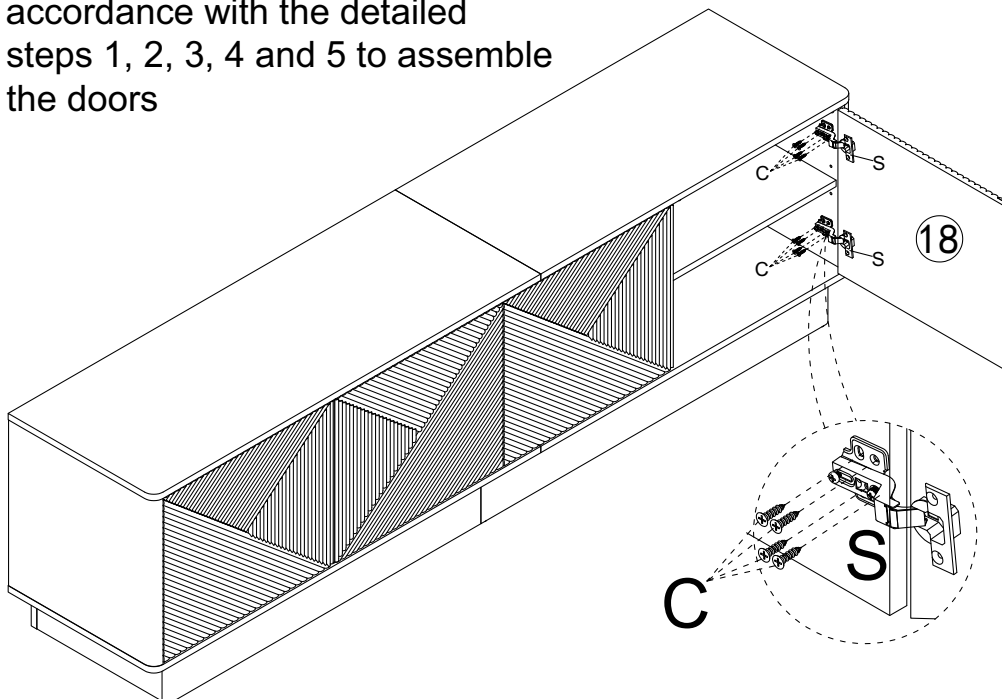

Tighten the screws only 30% as long as the door can be secured.

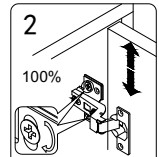

Move the door up and down until it is centred, then tighten the screw 100%.

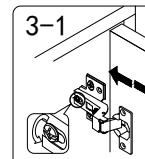

Loosen the screw anti-clockwise, and move the door in or out until it's aligned to side board.

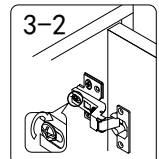

Tighten the screw clockwise once the door is aligned.

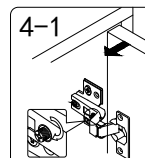

To adjust the gap between the door and the side board to be larger, turn the screw clockwise.

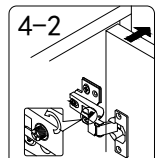

To adjust the gap between the door and the side board to be smaller, turn the screw anti-clockwise.

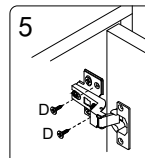

After adjusting the doors properly above, finally tighten these two screws and secured the door.

C	X8
	
M3.5x14mm	

Assembly Instructions

Step 26

