

ASSEMBLY INSTRUCTIONS

HYNS-003

HYNS-004

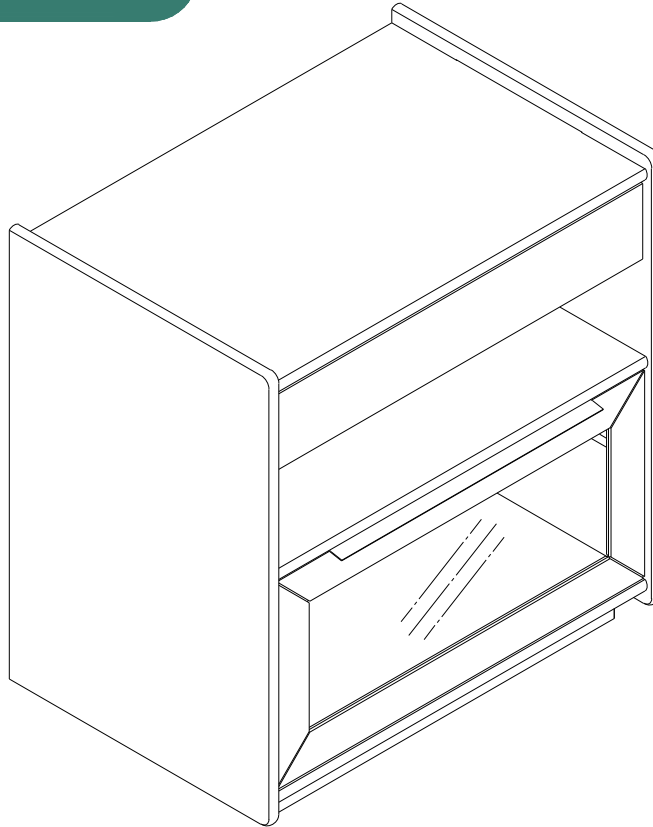

Notice:

1. Follow the installation instructions. Please confirm all accessories are preset before installation.
2. Do not fully tighten the screws during initial assembly. Fully tighten screws only once all pieces which are correctly assembled.
3. If you encounter any problems during installation, please contact our customer service.
4. Please unbox the item from the side with an open-label and put a carpet on the floor to avoid scratching it.

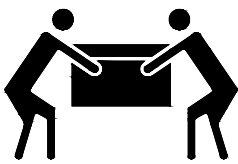

Recommended installers:2

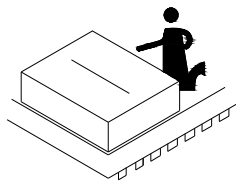

Put a carpet on the floor
before unpacking

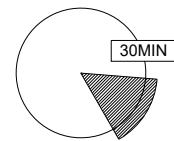

Estimate installation time:
30minutes





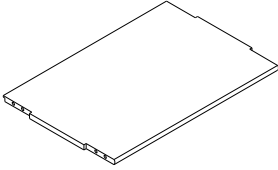
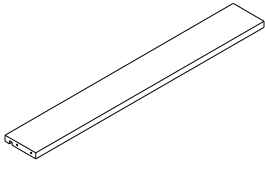
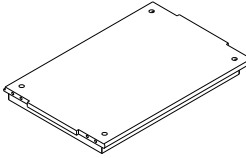
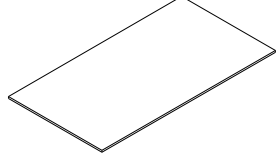
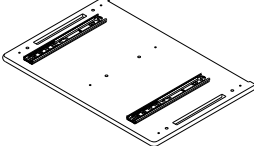
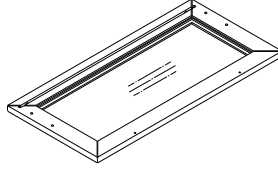
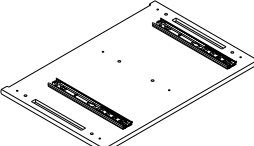
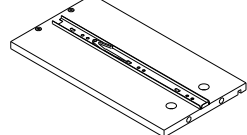
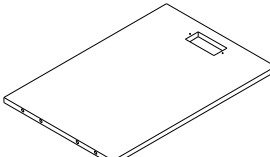
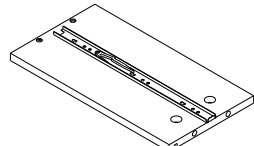
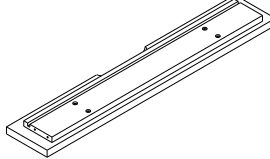
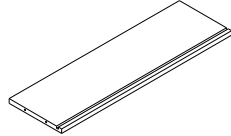
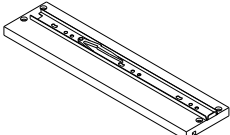
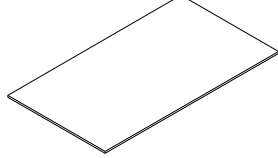
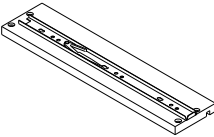
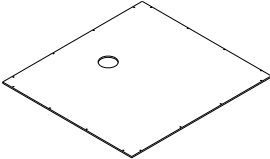

ASSEMBLY INSTRUCTIONS

PART LIST

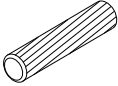
Item no.	Reference Image	Qty	Item no.	Reference Image	Qty
(A)		X1	(I)		X1
(B)		X1	(J)		X1
(C)		X1	(K)		X1
(D)		X1	(L)		X1
(E)		X1	(M)		X1
(F)		X1	(N)		X1
(G)		X1	(O)		X1
(H)		X1	(P)		X1

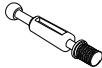
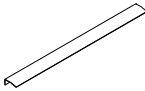
ASSEMBLY INSTRUCTIONS

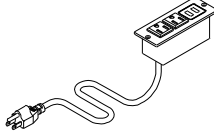
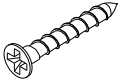
HARDWARE LIST

Item no.	Reference Image	Qty	Item no.	Reference Image	Qty
1	 Ø8*30mm	X12+1	5	 Ø3*15mm	X16+1
2		X16+1	6		X1
3	 Ø15*12mm	X12+1	7		X1
4	 Ø3.5*30mm	X12+1	8	 Ø3*15mm	X4
			9	 Ø15*9.5mm	X4

ASSEMBLY INSTRUCTIONS

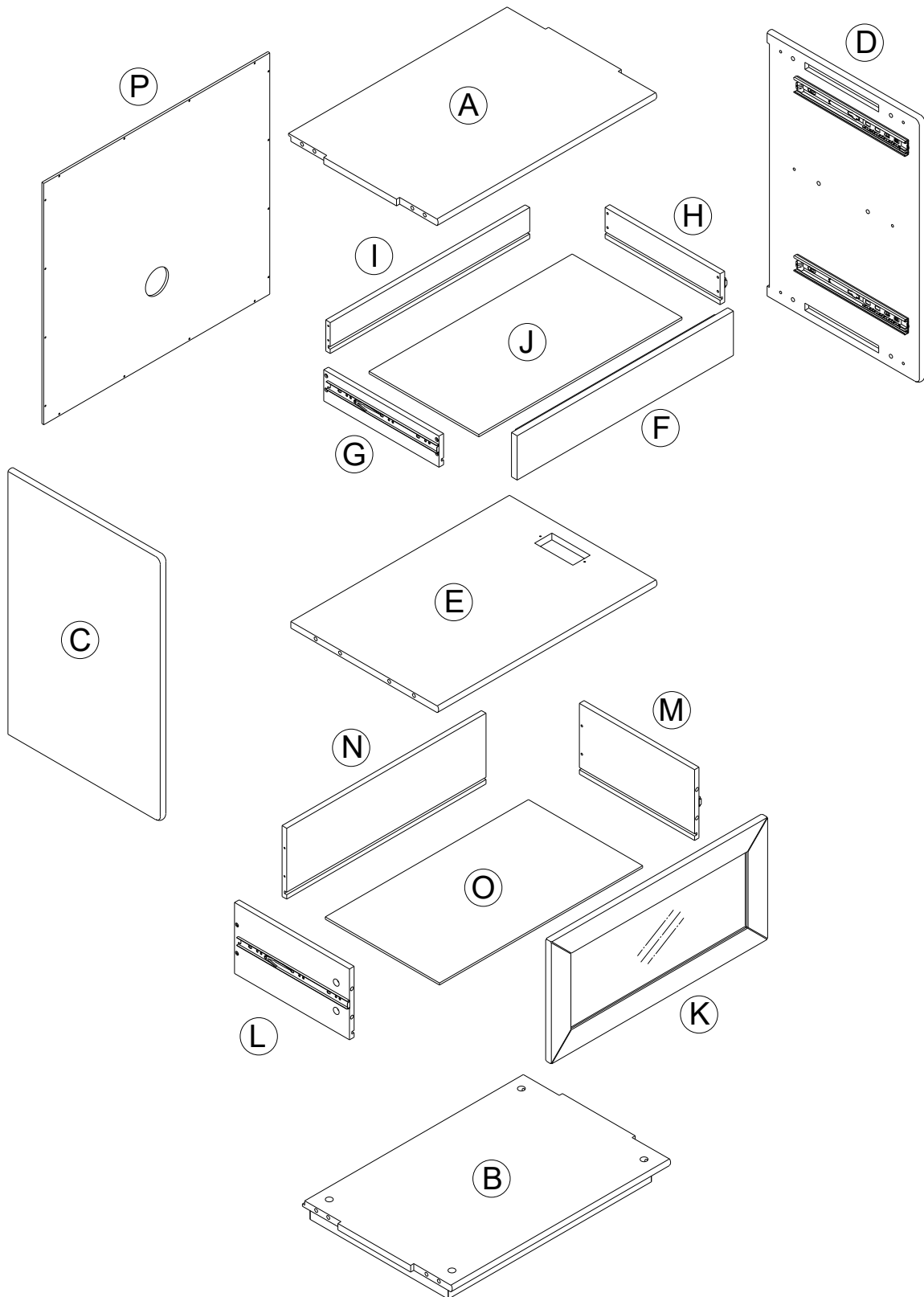

ASSEMBLY INSTRUCTIONS

1

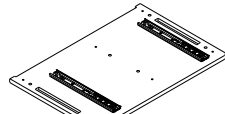

Ⓓ 1PC

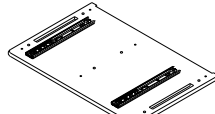

Ⓒ 1PC



② 12PCS

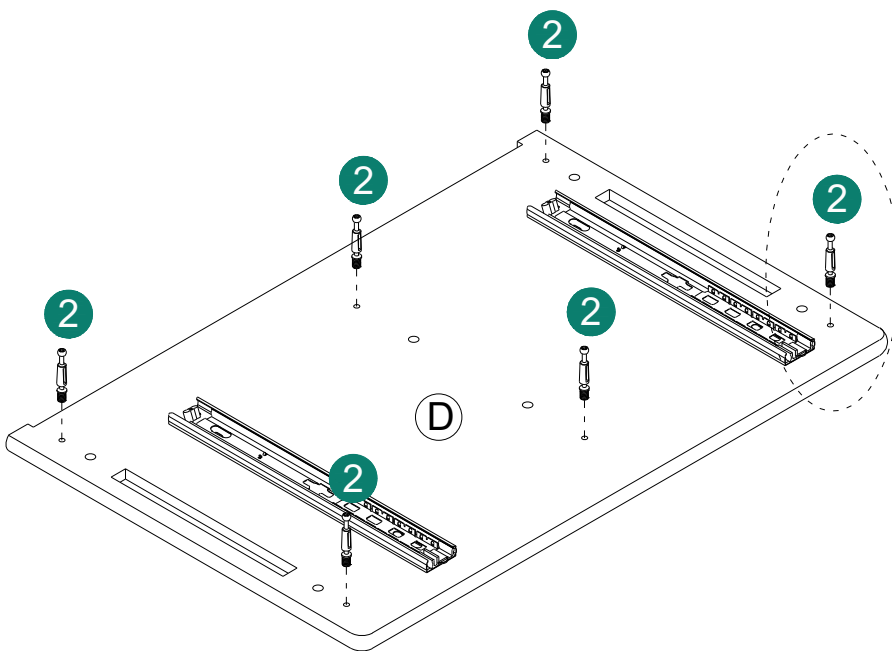
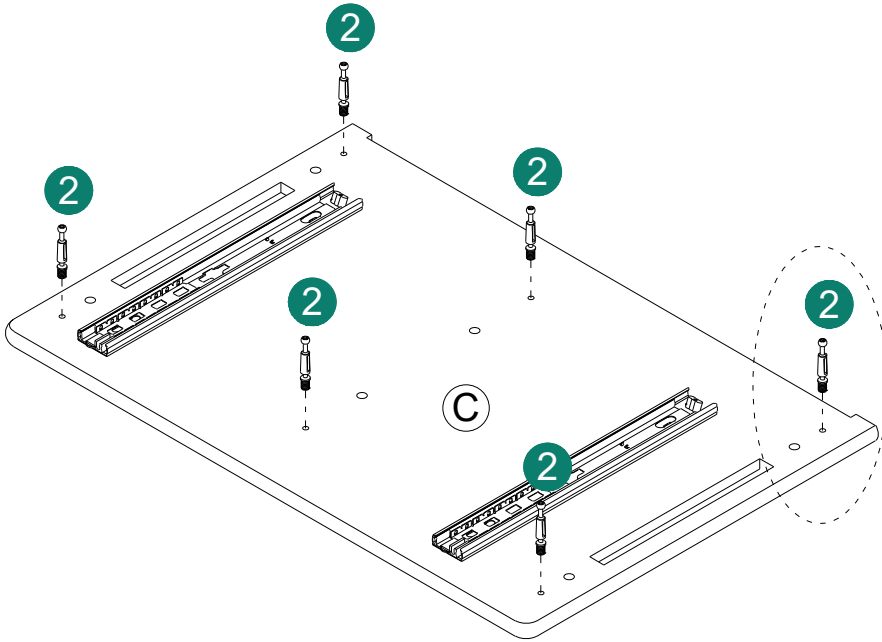

ASSEMBLY INSTRUCTIONS

2

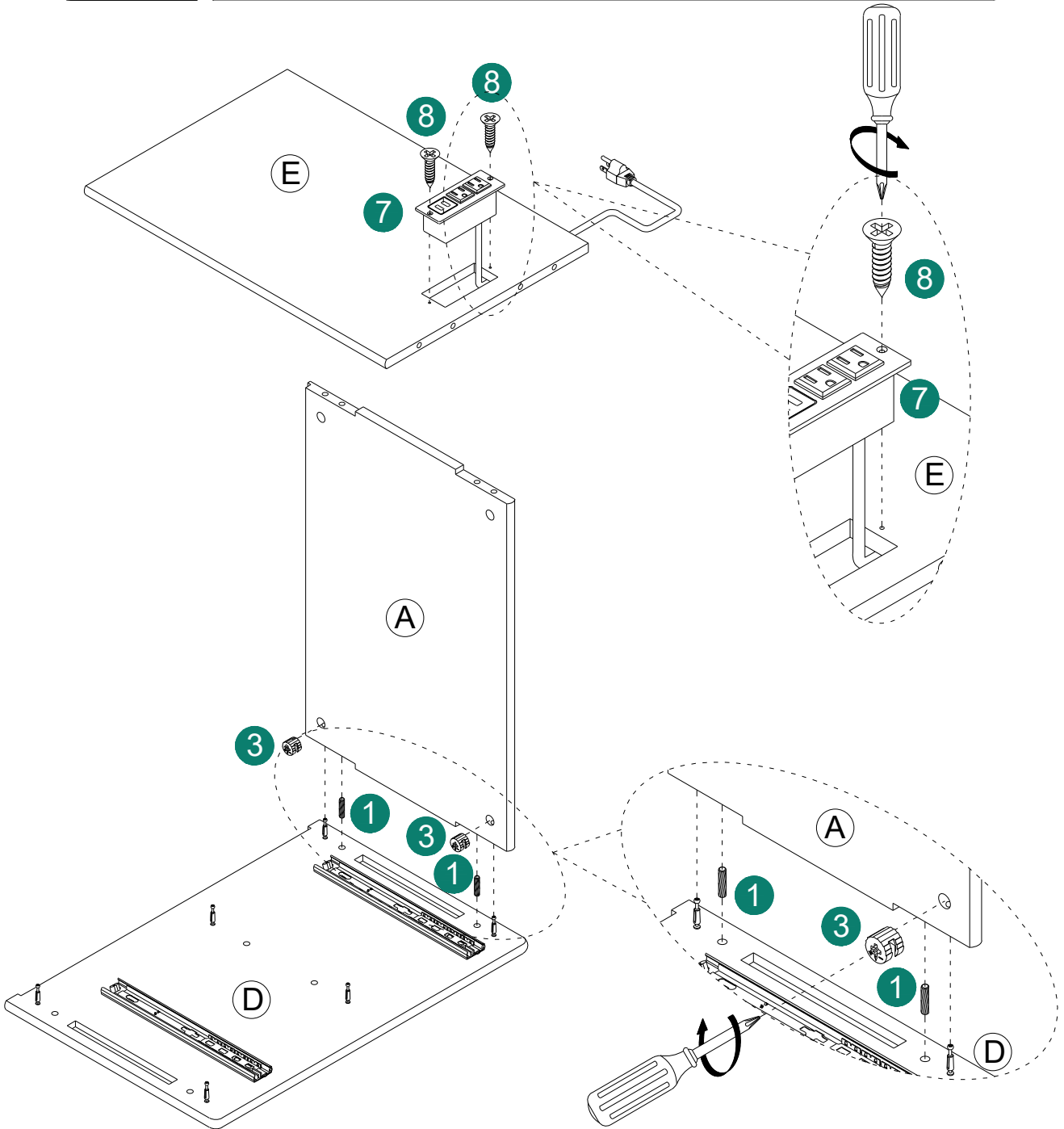
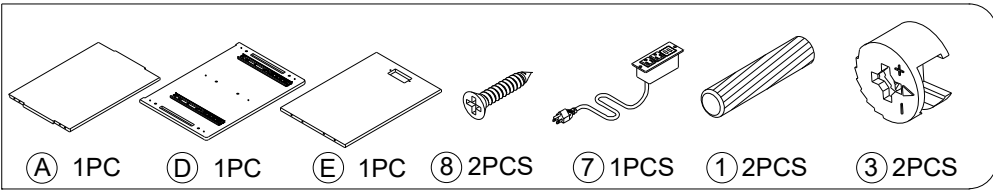

ASSEMBLY INSTRUCTIONS

3

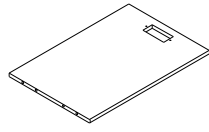

E 1PC

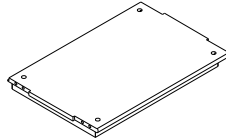

B 1PC

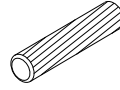

1 4PCS

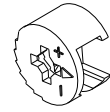

3 4PCS

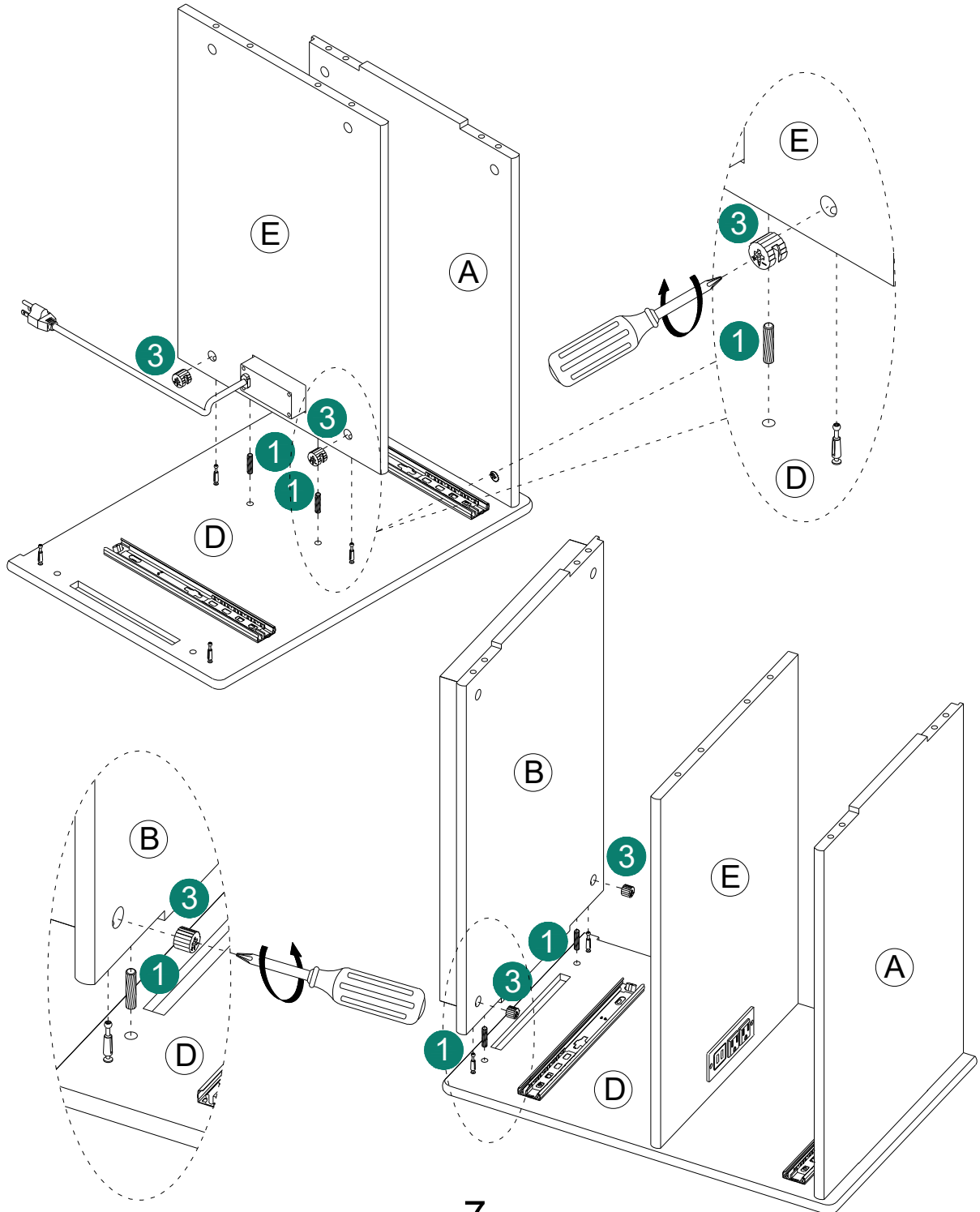

ASSEMBLY INSTRUCTIONS

4

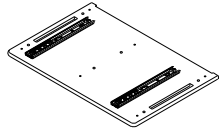

③ 1PC

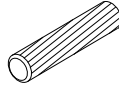

① 6PCS

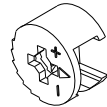

③ 6PCS

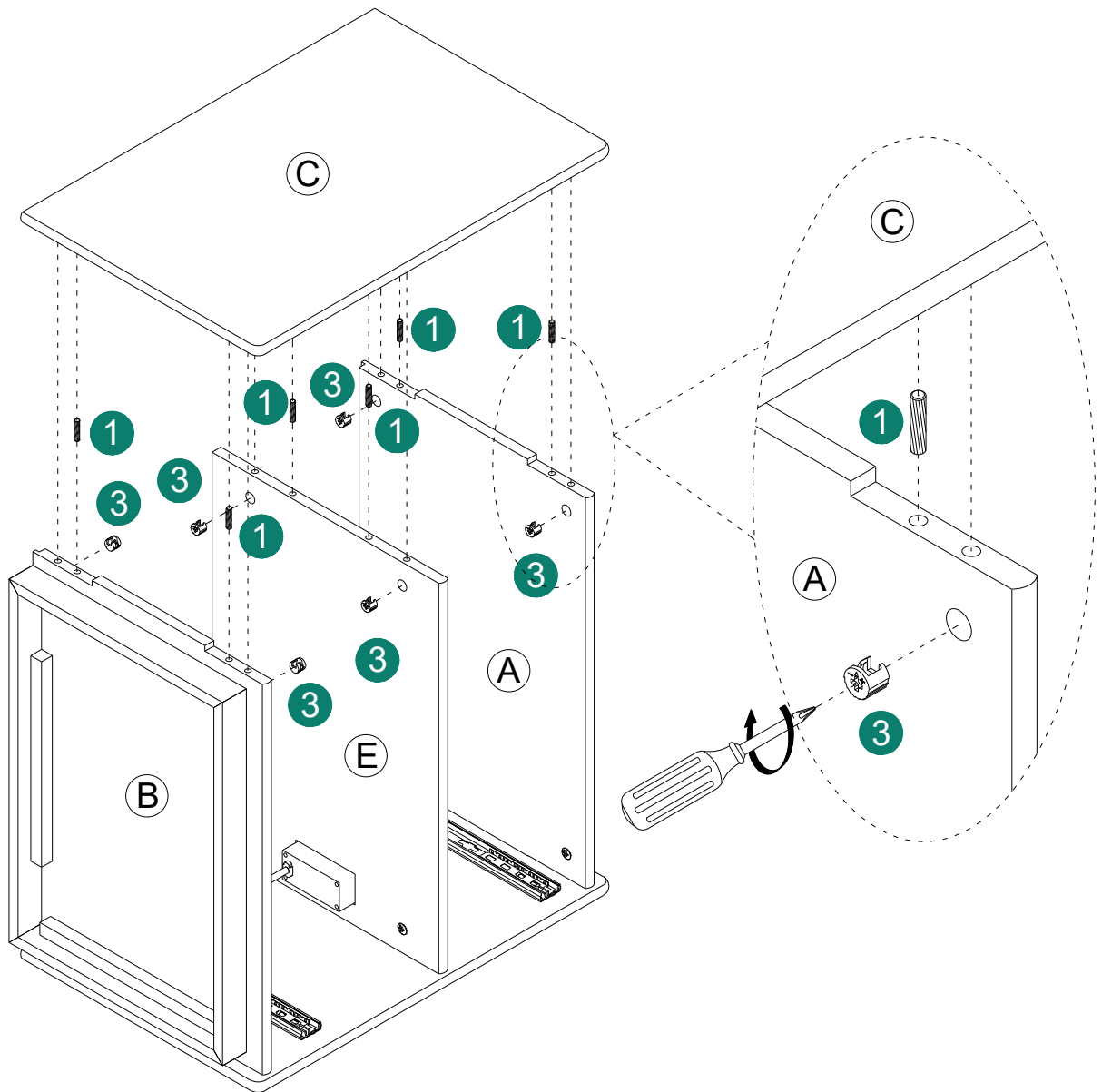

ASSEMBLY INSTRUCTIONS

5

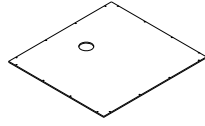

(P) 1PC

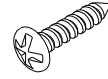

(5) 16PCS

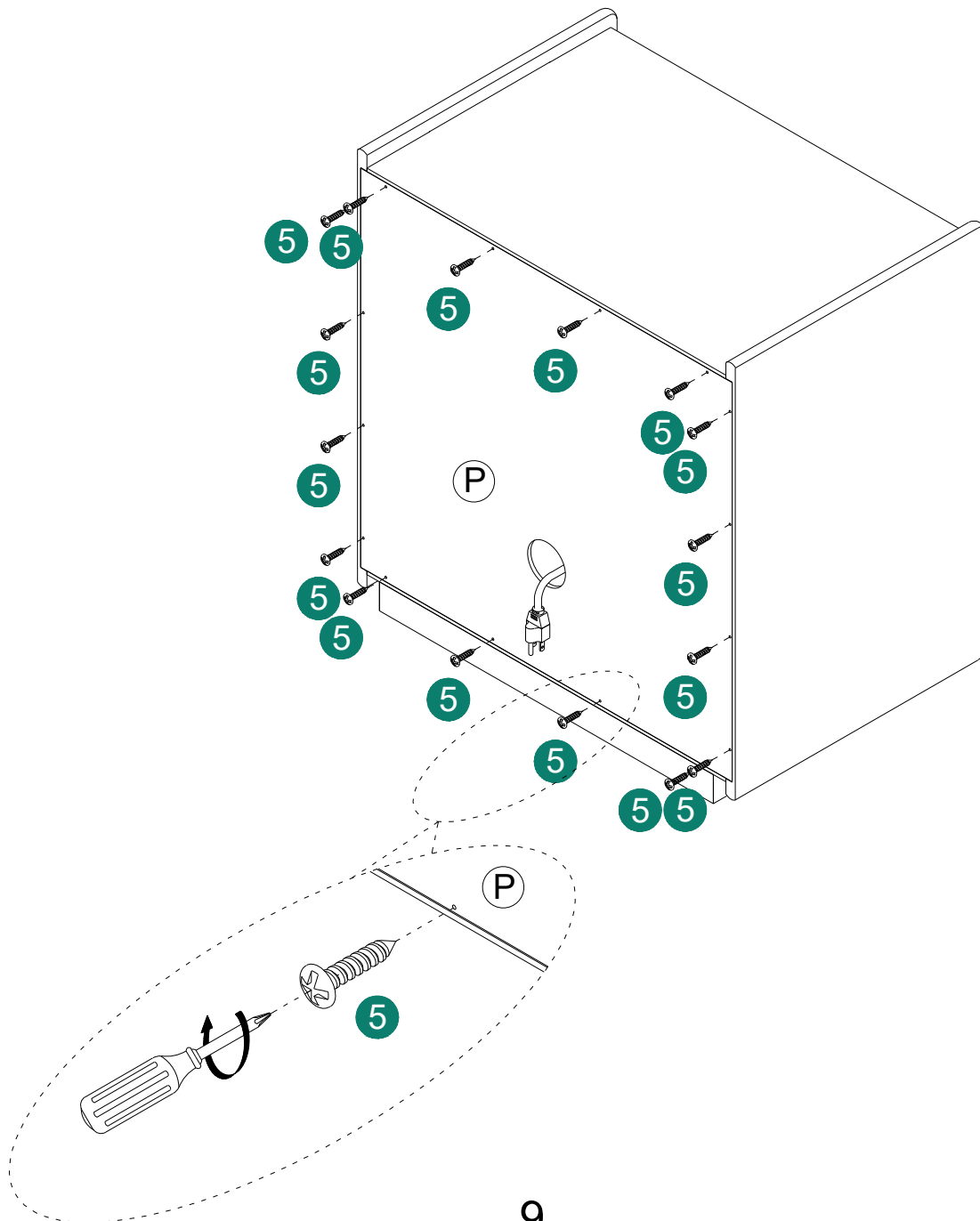

ASSEMBLY INSTRUCTIONS

6

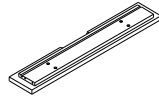

F 1PC

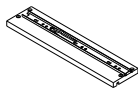

G 1PC

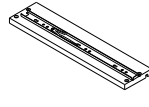

H 1PC

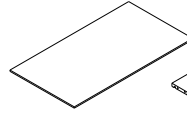

J 1PC

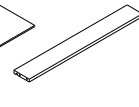

I 1PC



4 8PCS

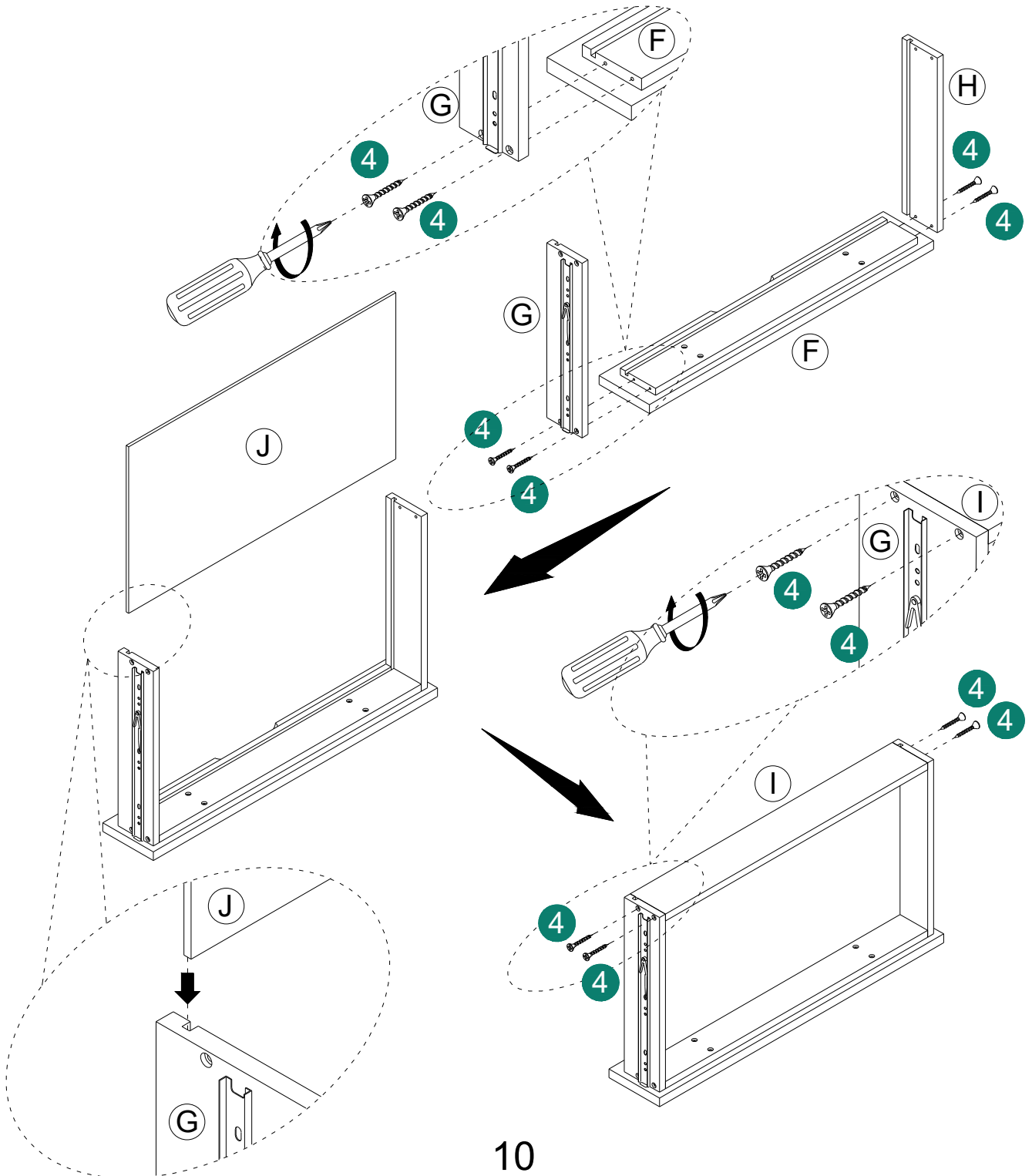

ASSEMBLY INSTRUCTIONS

7

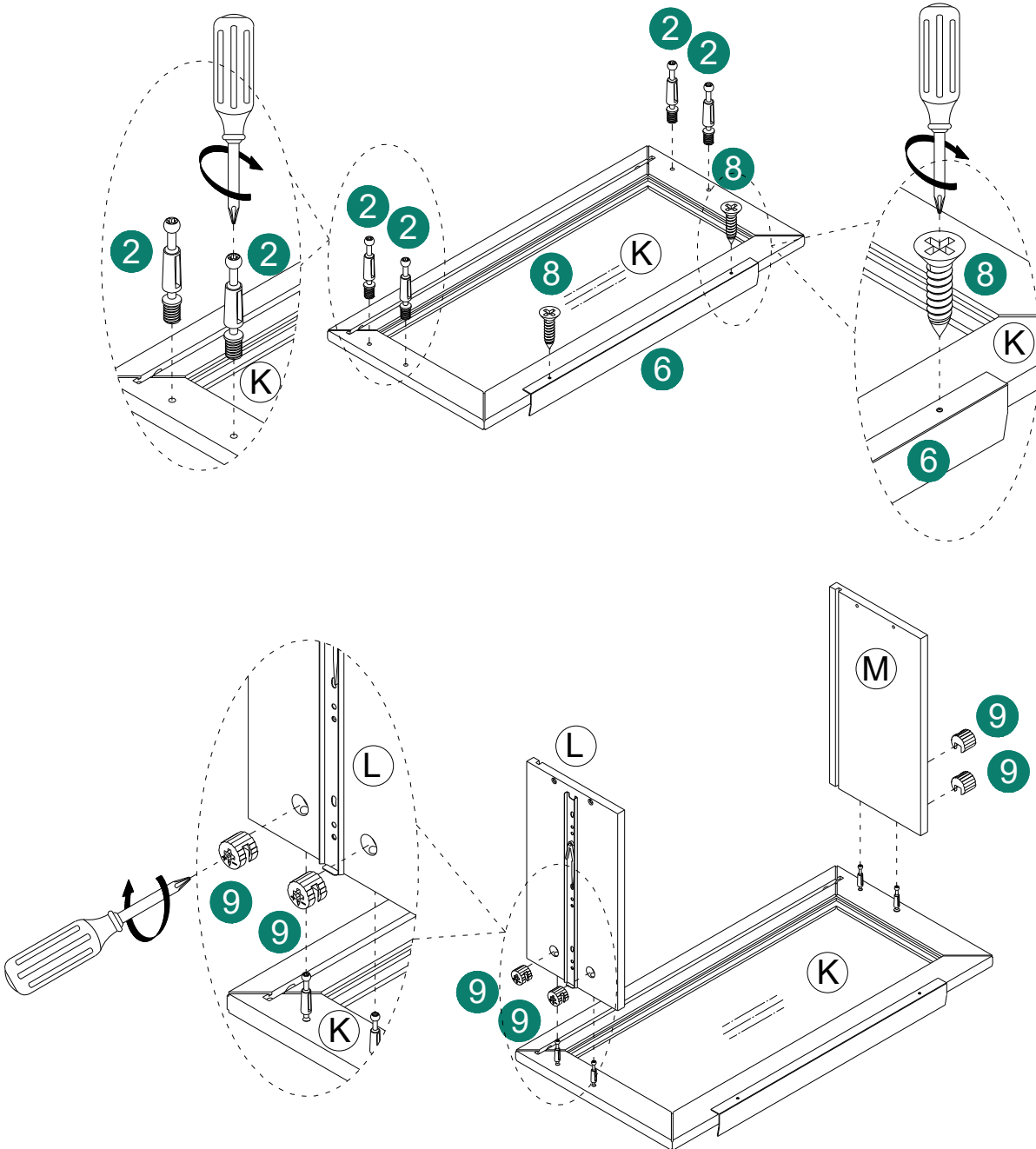
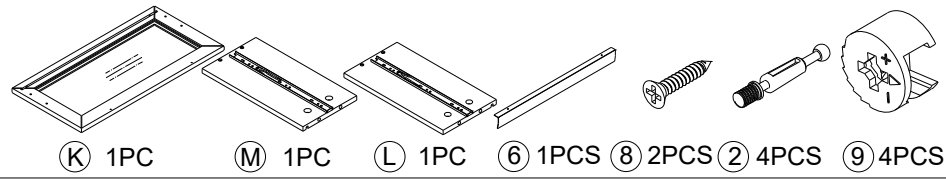

ASSEMBLY INSTRUCTIONS

8

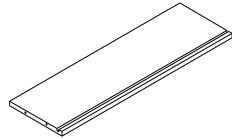

(N) 1PC

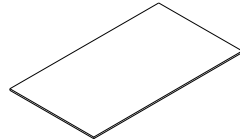

(O) 1PC

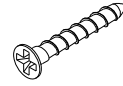

(4) 4PCS

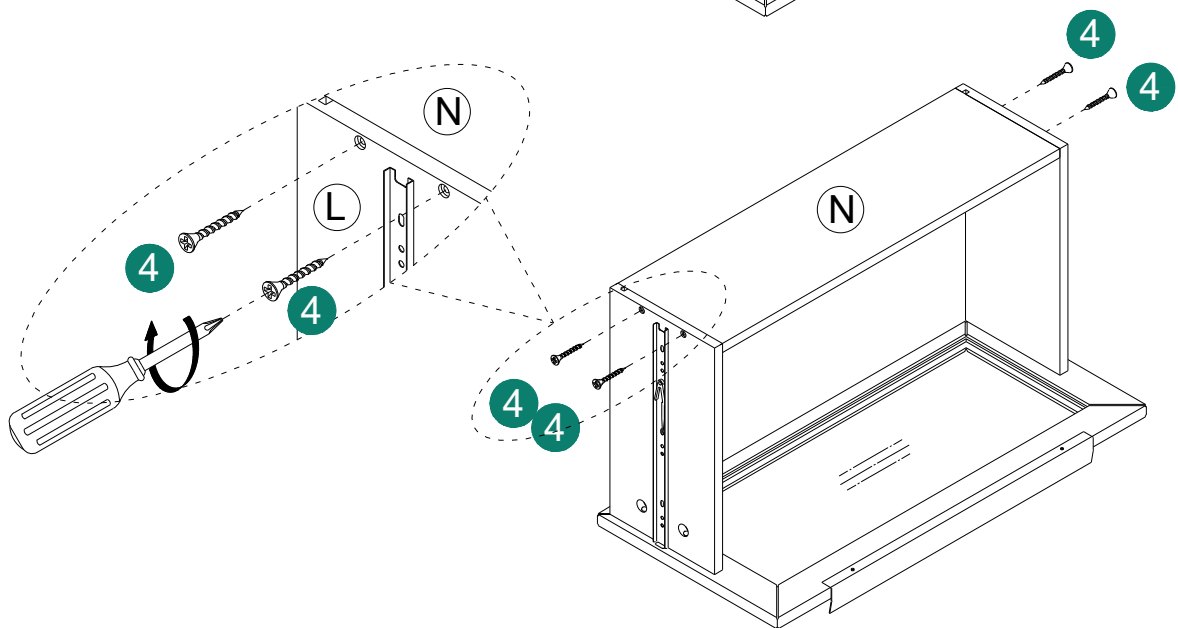
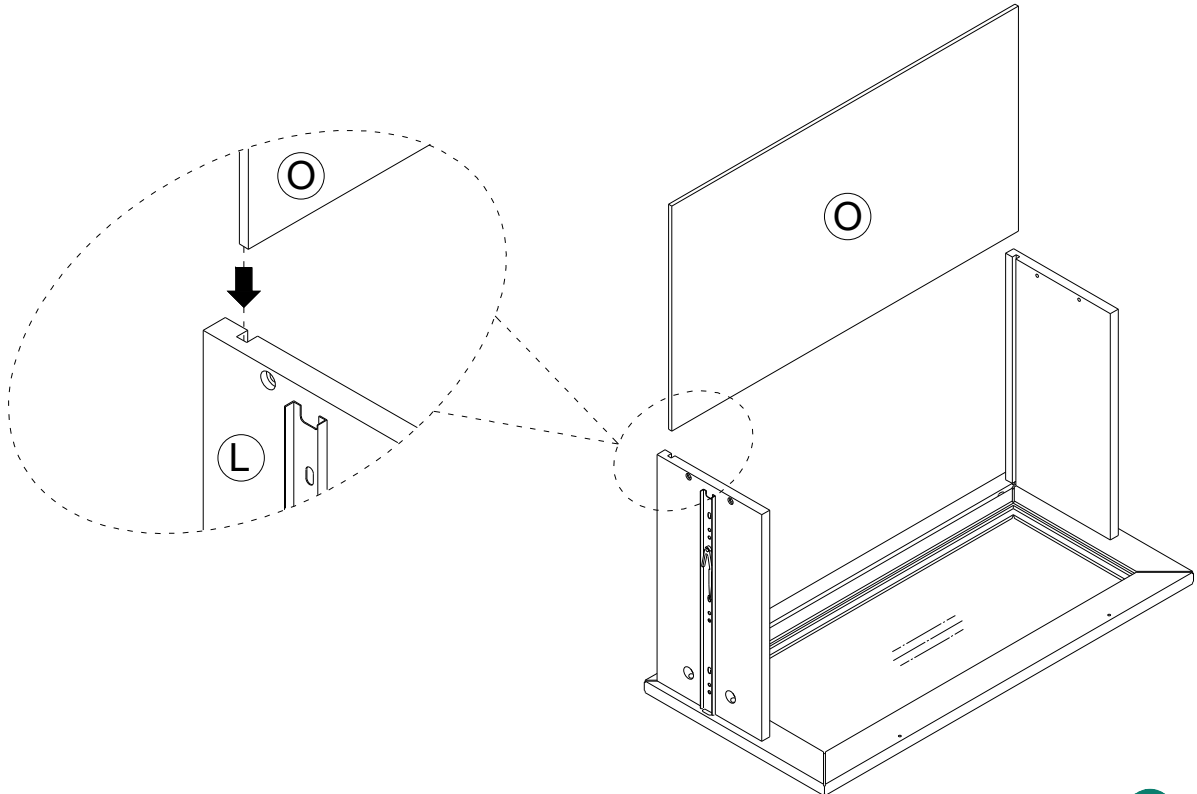

ASSEMBLY INSTRUCTIONS

9

