

# INSTALLATION MANUAL

## CEILING FAN WITH LIGHTS

Model No.: Y1095-BK

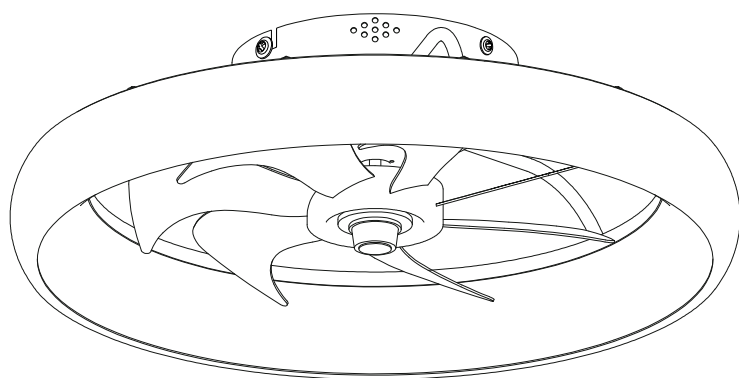

Scan for Installation Video



APP Control Applicable

### TOOLS REQUIRED



Ladder



Pliers



Wire  
Strippers

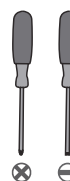

Screwdrivers

# Safety Rules

1. Be sure the power to the wires you are working on is disconnected, either the fuse is removed or the circuit breaker is turned off. Turning the power off using the light switch is not sufficient to prevent electrical shock.
2. A qualified licensed electrician is required for the installation.
3. The outlet box and support structure must be securely mounted and capable of reliably / supporting a minimum of 70 pounds. Use only UL (cUL for Canadian Installation) listed mounting boxes marked "FOR FAN SUPPORT".
4. The fan must be mounted with a minimum of 7 feet clearance from the trailing edge of the blades to the floor.
5. Do not operate reversing switch while fan blades are in motion (if applicable). Fan must be turned off and blades stopped before reversing blade direction.
6. Do not place any objects in the path of the blades.
7. To avoid personal injury or damage to the fan and other items, be cautious when working around or cleaning the fan.
8. Do not use water or detergents when cleaning the fan or fan blades. A dry dust cloth or lightly dampened soft cloth will be suitable for the cleaning.
9. After marking electrical connections, spliced conductors should be turned upward and pushed carefully up into outlet box. The wires should be spread apart with the grounded conductor on one side of the outlet box.
10. Electrical diagrams are reference only, different fan light may have different light shade and bulbs.
11. Use only our replacement parts. This equipment has been tested and found to comply with the limits for a class B digital device, pursuant to part 15 of the FCC Rules. These limits are to provide reasonable protection against harmful interference in a residential installation. This equipment generates, uses and can radiate radio frequency energy and if not installed and used in accordance with the instructions may cause harmful interference to radio communications.

## **Warning:**

To reduce the risk of personal injury, use only the two steel screws and washers provided with the outlet box for mounting to the outlet box. Most outlet boxes commonly used for the support of lighting fixtures are not acceptable for fan support and need to be replaced, consult a qualified electrician if in doubt.

To reduce the risk of fire, electric shock or person injury, mount fan to outlet box marked "acceptable for fan support".





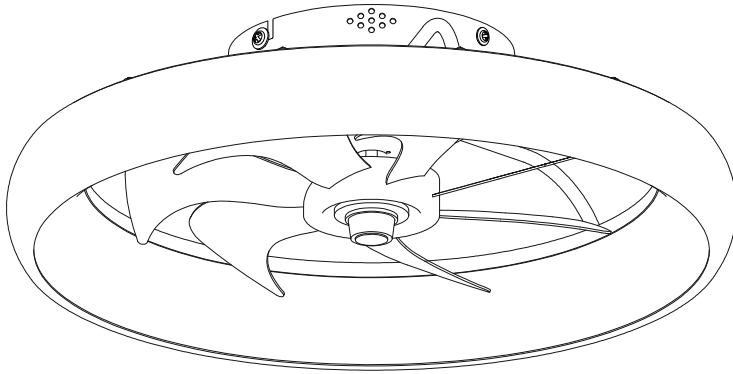







To reduce the risk of personal injury, do not bend the blade brackets (also referred to as flanges) during assembly or after installation. Do not insert objects in the path of the blades.

# PACKING LIST



**A** Fan Assembly ×1

# INSTALLATION KIT

<b>AA</b>  Mounting Bracket 1×	<b>BB</b>  Wire Nut 3×	<b>CC</b>  Outlet Box Screw 2×	<b>DD</b>  Flat Washer 2×	
<b>EE</b>  Wood Screw 4×	<b>FF</b>  Plastic Anchor 4×	<b>GG</b>  "S" Hook 1×	<b>HH</b>  Canopy Screw 4×	
<b>II</b>  Remote Holder Anchor 2×	<b>JJ</b>  Remote Holder Screw 2×	<b>KK</b>  Remote Control 1×	<b>LL</b>  Remote Holder 1×	<b>MM</b>  Pair of Gloves 1×

## NOTE:

1. The listed quantity is for installation, extra hardware may be included.
2. Mounting bracket (AA) and canopy screws (HH) are pre-installed on fan assembly (A).

# INSTALLATION

## 1. Install the Mounting Bracket

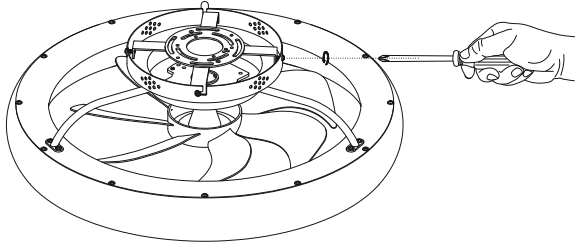

**Step 1:** Loosen and remove the canopy screws (HH) from the round holes, and loosen the canopy screws (HH) in the 'L' holes but do not remove them, and then remove the mounting bracket (AA) from the canopy.

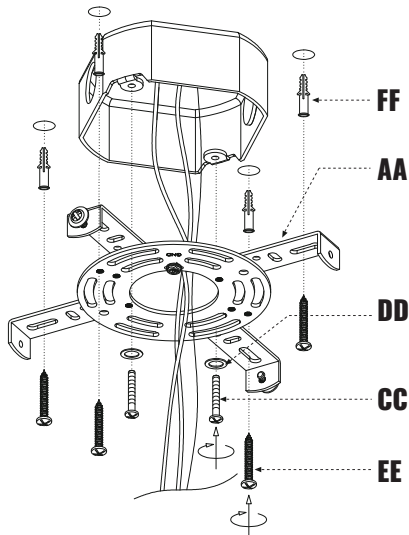

**Step 2:** Mark and drill screw holes in the ceiling, then insert the plastic anchors (FF).

**Step 3:** Use outlet box screws (CC) and flat washers (DD) to fix the mounting bracket (AA) to the outlet box, and then tighten it with wood screws (EE).

## 2. Hang the Fan

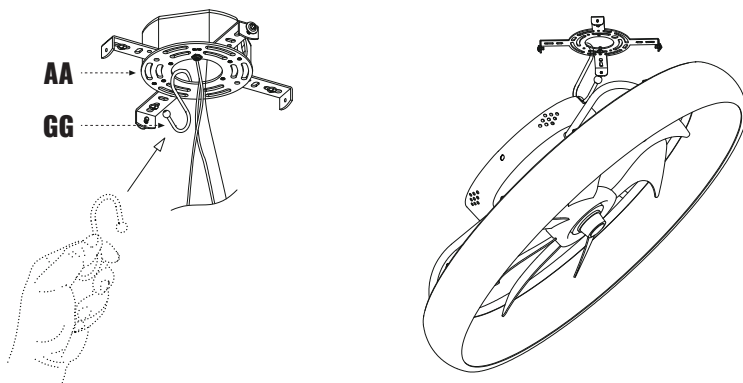

Hang the fixture onto the mounting bracket (AA) with "S" hook (GG) provided.

### 3. Connect the Wires

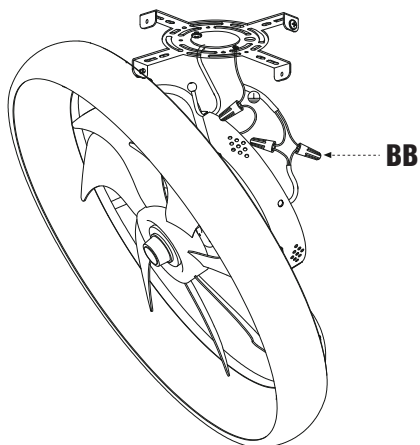

**Step 1:** Connect the wires from the fan to the house supply wires with wire nuts (BB), ground wire (green, green/yellow, or bare copper) to ground wire, neutral wire (white) to neutral wire, and hot wire (black) to hot wire. Wrap the connection with electrical tape.

**Step 2:** Spread apart the wires so that the hot wires are on one side of the outlet box and the neutral wires are on the other side.

**Note:**

This fan only needs one set of input wires (black, white, and ground wire). Both of the fan and lights will be controlled by the remote controller. This fan can only be connected to an on/off switch if you have one, not a dimmer switch.

### 4. Attach the Canopy

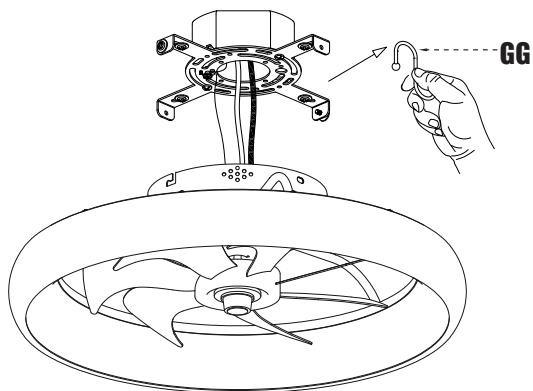

Take away the "S" hook (GG).

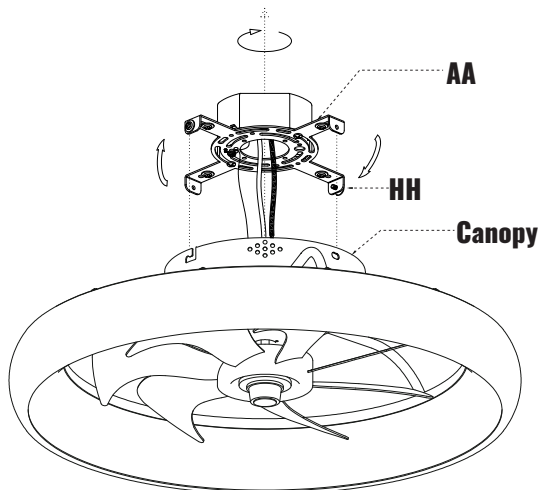

Align the "L" slots from the canopy to the canopy screws (HH) on the mounting bracket (AA), rotate the canopy to lock it onto the mounting bracket (AA).

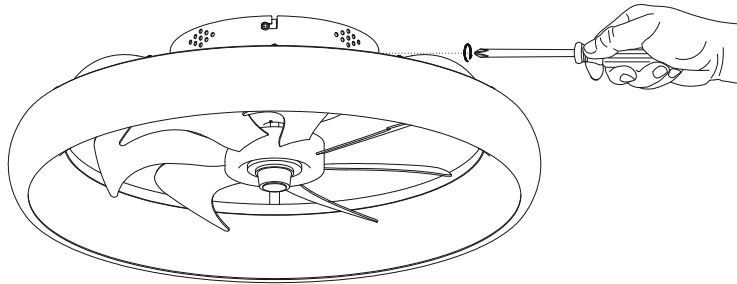

Tighten the canopy screws (HH).

## 5. Install the Remote Holder

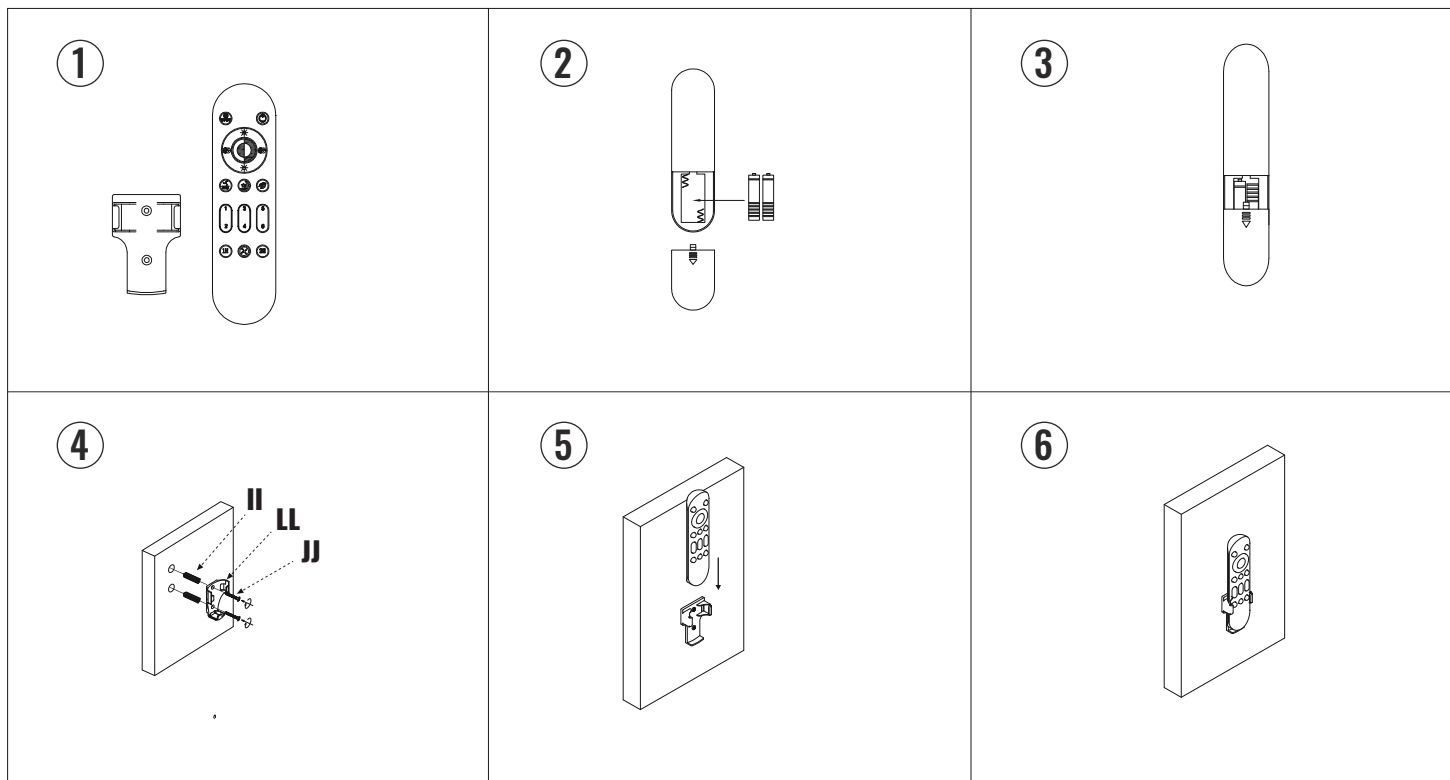

1. Insert 2 batteries before using: AAA 1.5V battery x 2pcs (not included).
2. Mark and drill screw holes in the wall, then insert the remote holder anchors (II).
3. Use remote holder screws (JJ) to fix the remote holder (LL) onto the wall.

# REMOTE CONTROL INSTRUCTIONS

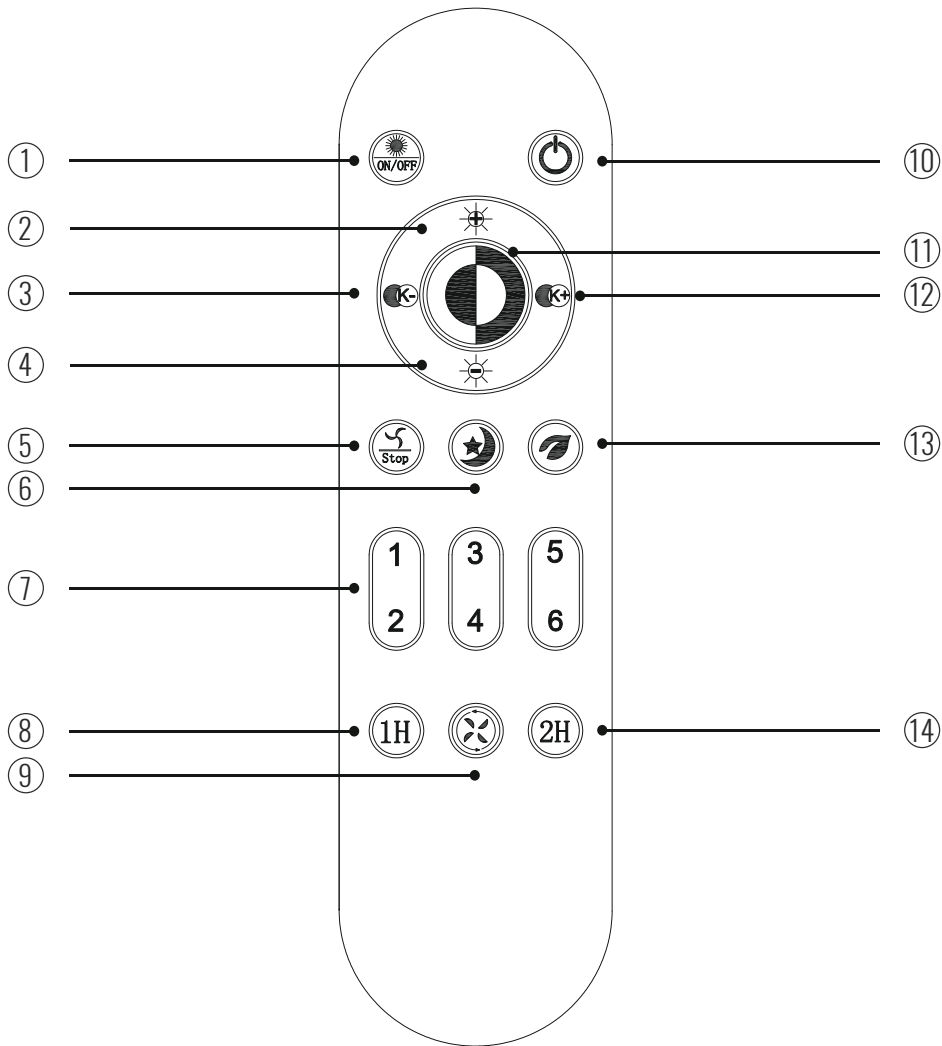

- ① Turn on/off the light.
- ② ④ Adjust the brightness of the light.
- ③ ⑫ Adjust the light color temperature.
- ⑤ Stop the fan.
- ⑥ Night mode, lights will be dimmed when press this button.
- ⑦ 1-6 fan speed.
- ⑧ ⑭ Timing the fan
- ⑨ Fan moves forwards or reversely.
- ⑩ Turn off fan and light.
- ⑪ Quick switch of the light color: Yellow Light→White Light→Natural Light
- ⑬ Natural wind of the fan, fan speed will change automatically.

















## REMOTE SIGNAL PAIRING:

If the remote control loses signal of the fan, press and hold ⑪ button at the very beginning after it's turned on from wall switch. After the light flashes, it's done.

# APP CONTROL INSTRUCTIONS

Install the "FanLamp Pro" app from Google Play, Apple App Store, or other app stores by scanning the QR code or searching for the app name. Ensure that your phone is connected to the internet and Bluetooth enabled.



-  Pairing: Click the Pair button within 5 seconds after turning on the fan from the wall switch. Once the fan flashes or beeps, it has been successfully paired with your phone and can now be controlled through the app.
-  Slide the slider to change the fan speed.
-  Slide the slider to change the brightness of the light.
-  Quick switch for "White" light color.
-  Quick switch for "Yellow" light color.
-  Quick switch for "Natural" light color.
-  Night mode: Dim the lights.
-  Fan moves forward.
-  Fan moves reversely.
-  Change the direction of the wind. (Not supported)
-  Timing the fan.
-  Natural wind: The fan speed will change automatically when you use this function
-  Sleeping wind. (Not supported)
-  Turn on/off the light.
-  Turn on/off the fan.
-  Unpairing: Click the unpair button within 5 seconds after turning on the fan. Once the fan flashes or beeps, it has been successfully unpaired from your phone.