

# INSTALLATION GUIDE FOR DS19226B AND DS19226B1

## SAFETY INFORMATION

Released Date: 2021-10-11

Please read and understand this entire manual before attempting to assemble, install or operate the product.

### WARNING

- RISK OF ELECTRIC SHOCK - Before beginning installation, turn off electricity at the circuit breaker box or the main fuse box.
- RISK OF FIRE - Use bulbs specified by the markings and/or labels on the fixture.

### CAUTION

- For your safety, read instructions completely before beginning installation.
- If in doubt about electrical installation, consult a licensed electrician.
- Turn off electricity to fixture before replacing the bulb(s).

### TOOLS REQUIRED

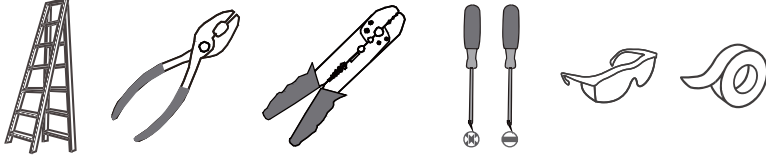

## CARE AND MAINTENANCE

- Wipe clean using soft, dry cloth or static duster. Always avoid using harsh chemicals and abrasives to clean fixture as they may damage the finish.

If you need further assistance email [customer care@ashleyharbour.com](mailto:customer care@ashleyharbour.com).

## PACKAGE CONTENTS

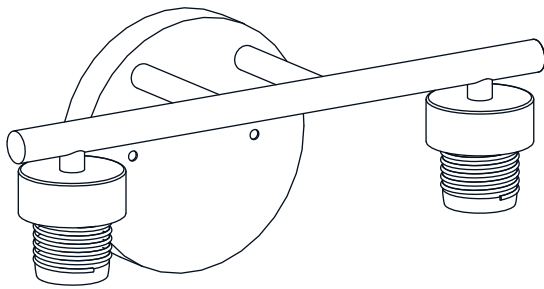

**A** Fixture Body  
x 1

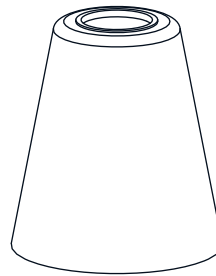

**B** Shade  
x 2

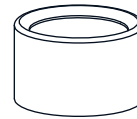

**C** Socket Collar  
(preassembled  
on Fixture Body)  
x 2

## MOUNTING HARDWARE

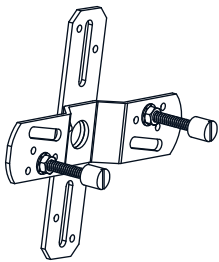

**AA** Inner Backplate  
x 1



**BB** Wire Connector  
x 3



**CC** Outlet Box Screw  
x 2

# INSTALLATION

## 1 Install Crossbar Assembly

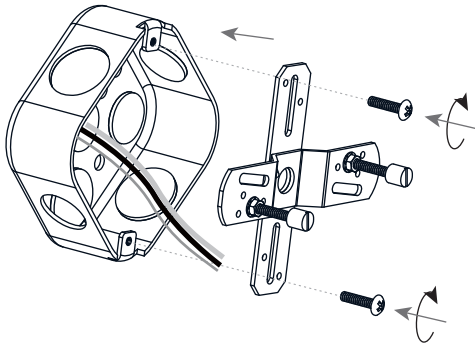

## 2 Wiring

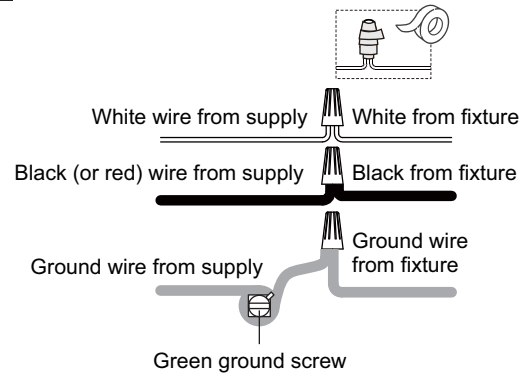

## 3 Install Fixture

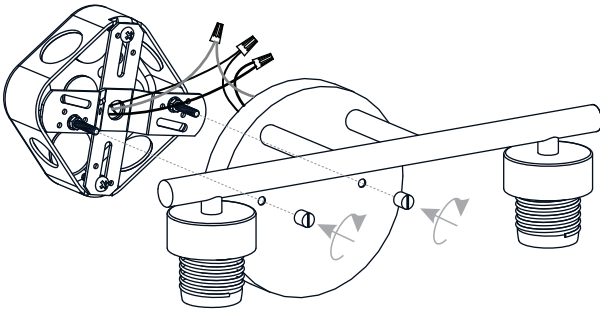

## 4 Install Shades and Bulbs

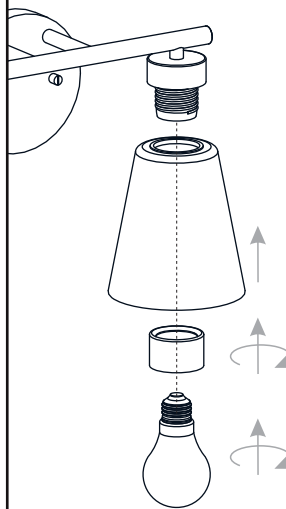

Install two correct bulbs referring to fixture markings and/or labels for maximum wattage.

**Recommended Bulb Type (not included):**

  
BULB BASE TYPE  
Medium (E26)

  
100W  
MAX  
BULB TYPE  
TYPE A

Your installation is now complete! Restore electricity and save this sheet for future reference.