











Assembly Instructions

Caution : You must read this before you proceed

Care & Maintenance

- ⊘  ● Not for commercial use. For residential use only.
 - ✓  ● Furniture may scratch floors. We recommend using furniture pads to protect your floors.
 - ⊘  ● Do not put hot items directly on furniture surface.
 - ⊘  ● Do not clean furniture with harsh cleansers or polish.
 - ⊘  ● Do not place furniture under direct sunlight.
 - ⊘  ● Do not place furniture near heating or cooling vents.
 - ⊘  ● Do not write on furniture without a padded barrier to protect the surface.
 - ⊘  ● Do not place furniture outside . For indoor use only.
 - ⊘  ● Stains may be removed with mild soap solution and damp cloth.
 - ⊘  ● Children should not climb or jump on the furniture.
- ✓  ● Dust and pick-up spills using a clean, non-colored, lint-free cloth.

Please look in packaging cardboard box for hardware packs and legs.
Sets often ship in multiple boxes and may arrive a day or two apart.

Left Armchair

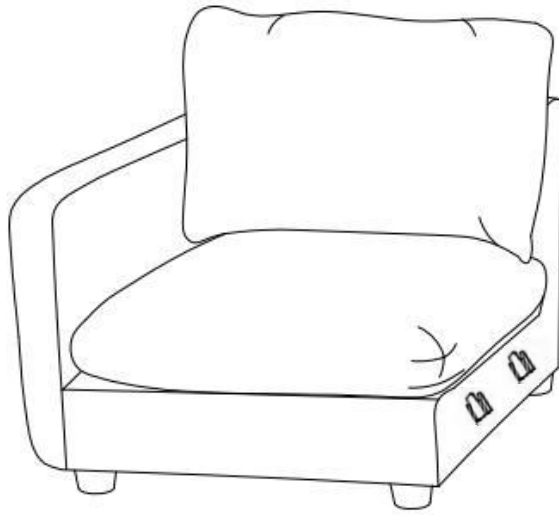





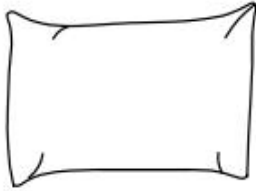

Parts List

Label	Picture	Description	QTY
A	A line drawing of a curved, rectangular armrest with a small notch on the bottom edge.	Left armrest	1
B	A line drawing of a rectangular seat base with a recessed top surface and a slightly raised edge.	Seat base	1
C	A line drawing of a rectangular backrest with a curved top edge and a slightly raised bottom edge.	Backrest	1
D	A line drawing of a cylindrical wooden leg with a small black cylindrical cap on top.	Wooden leg	4

E		Seat cushion	1
F		Back cushion	1

Hardware

Label	Picture	Description	QTY
①		Screw	6
②		Connecting piece	2
③		Allen wrench	1
④		Spring gasket	6
⑤		Gasket	6
⑥		Plastic gasket	7



- Read instructions, cover to cover-



- Have 2 adults on hand for assembly-



- Do not assemble on flooring or carpet-



- Assemble on a clean non-marring surface (packing foam)-



- Save all packaging until finished-

Assembly Steps

Overview

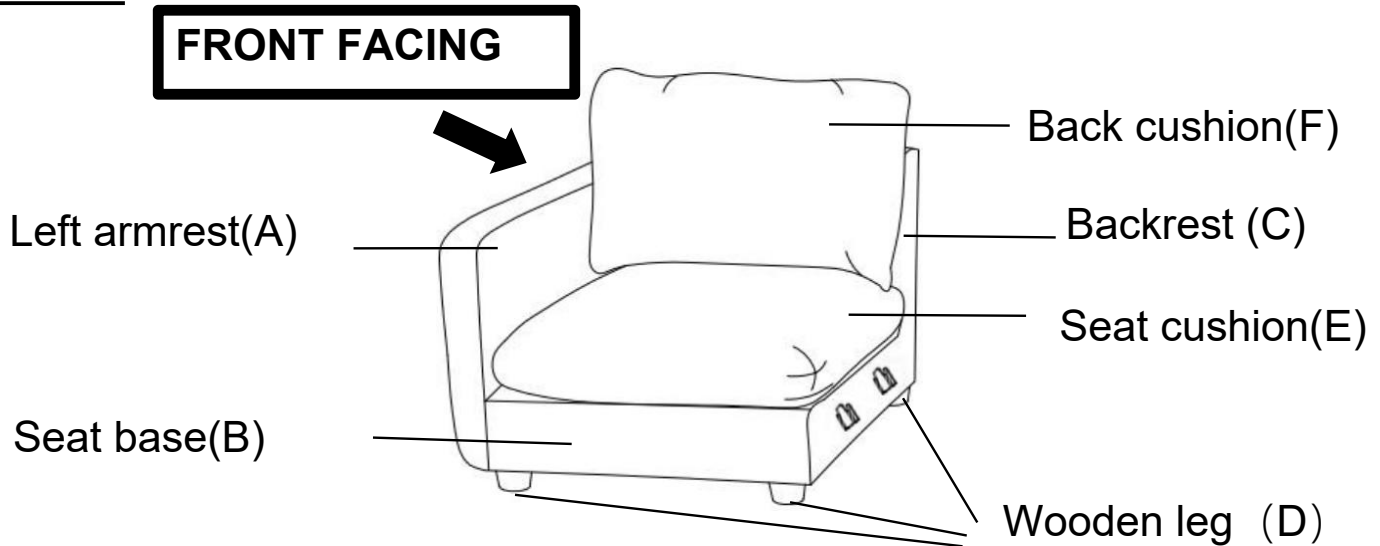

This Left Armchair has multiple parts and may require up to some 15 minutes to assemble. To give you an overview of the parts, the above picture is to help you put the various parts into perspective. Please read through the instructions below to familiarise yourself with the parts and steps before assembly.

Step 1

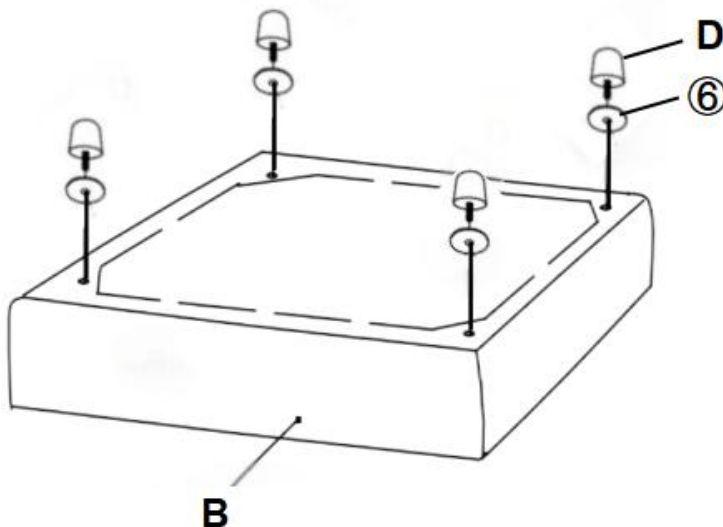

Assemble Wooden leg(D) and Plastic gasket(6) with Seat base B and rotate clockwise

Step 2

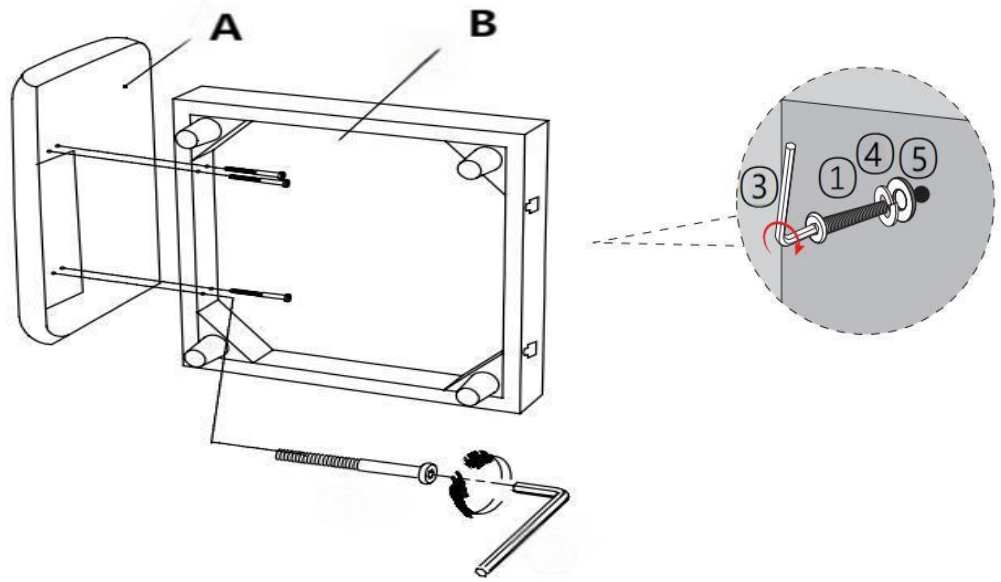

Place the Seat base(B) and the Left armrest(A) on the side, and then fix them together with Screws (①), Spring gasket (④), Gaskets(⑤), Allen wrench(③) . There are a total of 4 Screws.

Step 3

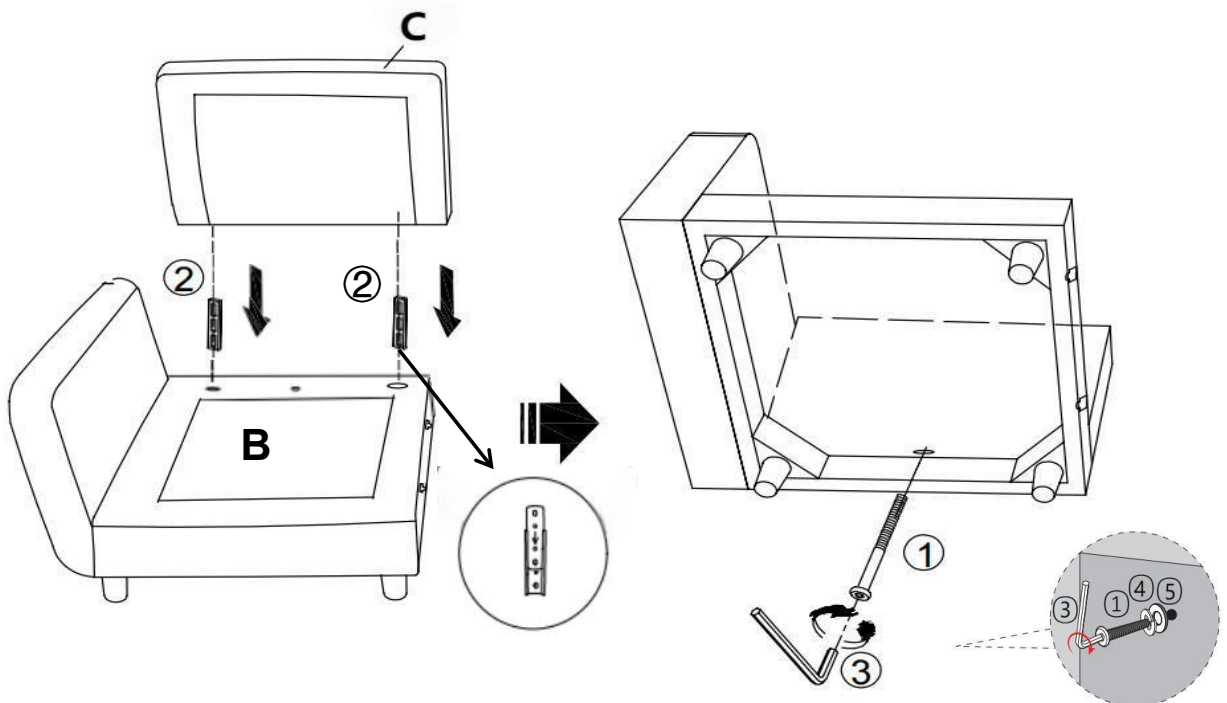

First, install the Connecting piece (②) on the Seat base (B), then install the Backrest (C) onto the Seat base (B) through the Connecting piece (②), and then place the Seat base (B) on the side. Use an Allen wrench(③) to tighten the Screw(①) , Spring gasket (④), Gaskets(⑤) from the bottom.

Step 4

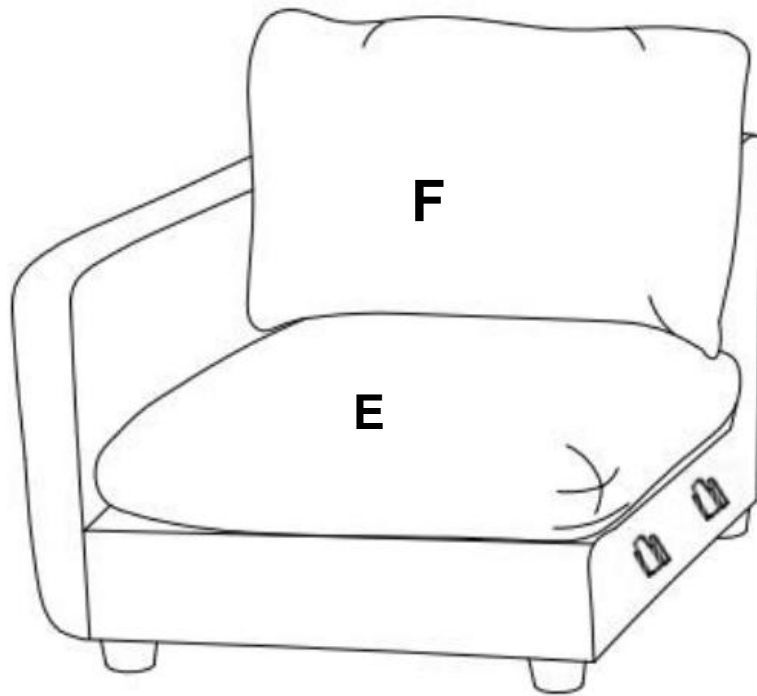

Unpack the Back cushion (F) and Seat cushion (E) (restore to their original state in 3 minutes), and arrange as shown above.

Step 5

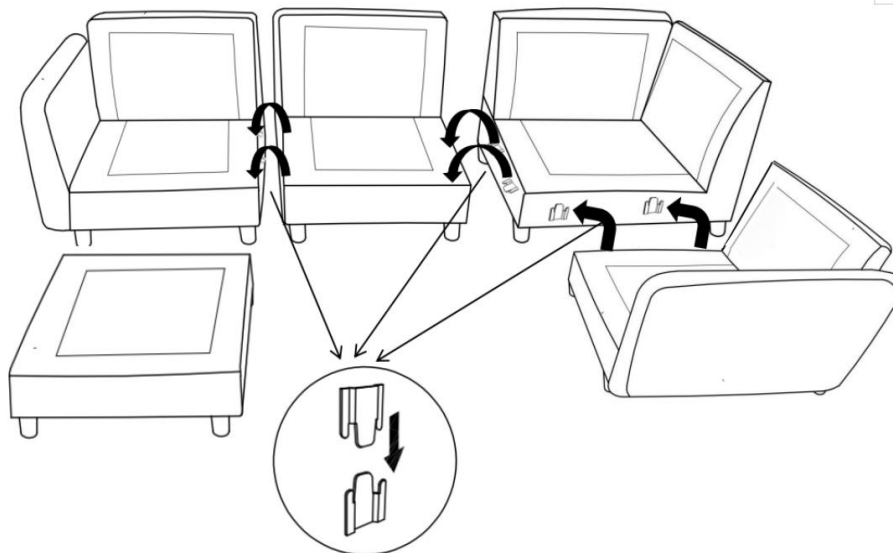

With the assistance of your adult partner, place the Chairs facedown and connect the chair using the installed mountain shaped insert.

Note: This is an optional step in case you want to connect all the Chairs in the set together and should be performed before affixing the cushions.

Questions & Answers about Proposition 65

- What is Proposition 65?

Proposition 65 requires businesses to provide warnings to Californians about significant exposures to chemicals that cause cancer, birth defects or other reproductive harm.

These chemicals can be in the products that Californians purchase, in their homes or workplaces, or that are released into the environment. By requiring that this information be provided, Proposition 65 enables Californians to make informed decisions about their exposures to these chemicals.

Proposition 65 also prohibits California businesses from knowingly discharging significant amounts of listed chemicals into sources of drinking water.

Proposition 65 requires California to publish a list of chemicals known to cause cancer, birth defects or other reproductive harm. This list, which must be updated at least once a year, has grown to include approximately 900 chemicals since it was first published in 1987.

- What types of chemicals are on the Proposition 65 list?

The list contains a wide range of naturally occurring and synthetic chemicals that include additives or ingredients in pesticides, common household products, food, drugs, dyes, or solvents. Listed chemicals may also be used in manufacturing and construction, or they may be byproducts of chemical processes, such as motor vehicle exhaust.

- What does a warning mean?

If a warning is placed on a product label or posted or distributed at a workplace, a business, or in rental housing, the business issuing the warning is aware or believes that it is exposing individuals to one or more listed chemicals.

By law, a warning must be given for listed chemicals unless the exposure is low enough to pose no significant risk of cancer or is significantly below levels observed to cause birth defects or other reproductive harm.











- Where can I get more information on Proposition 65?

If you have specific questions on the administration or implementation of Proposition 65, you can contact OEHHA's Proposition 65 program at P65.Questions@oehha.ca.gov, or by phone at (916) 445-6900.

Assembly Instructions

Caution : You must read this before you proceed

Care & Maintenance

- ⊘  ● Not for commercial use. For residential use only.
- ✓  ● Furniture may scratch floors. We recommend using furniture pads to protect your floors.
- ⊘  ● Do not put hot items directly on furniture surface.
- ⊘  ● Do not clean furniture with harsh cleansers or polish.
- ⊘  ● Do not place furniture under direct sunlight.
- ⊘  ● Do not place furniture near heating or cooling vents.
- ⊘  ● Do not write on furniture without a padded barrier to protect the surface.
- ⊘  ● Do not place furniture outside . For indoor use only.
- ⊘  ● Stains may be removed with mild soap solution and damp cloth.
- ⊘  ● Children should not climb or jump on the furniture.



- Dust and pick-up spills using a clean, non-colored, lint-free cloth.

Please look in packaging cardboard box for hardware packs and legs.
Sets often ship in multiple boxes and may arrive a day or two apart.

Right Armchair

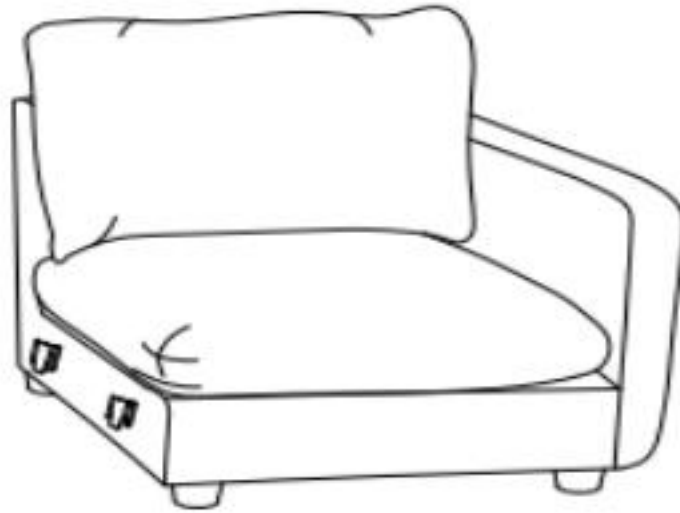





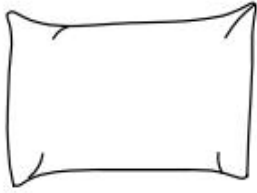

Parts List

Label	Picture	Description	QTY
A	A line drawing of a right armrest, showing its curved shape and the attachment points on the sides.	Right armrest	1
B	A line drawing of a rectangular seat base, showing its flat top surface and slightly raised edges.	Seat base	1
C	A line drawing of a rectangular backrest, showing its slightly curved top edge and the attachment points on the sides.	Backrest	1
D	A line drawing of a wooden leg, consisting of a cylindrical base with a small black cylindrical cap on top.	Wooden leg	4

E		Seat cushion	1
F		Back cushion	1

Hardware

Label	Picture	Description	QTY
①		Screw	6
②		Connecting piece	2
③		Allen wrench	1
④		Spring gasket	6
⑤		Gasket	6
⑥		Plastic gasket	7



- Read instructions, cover to cover-



- Have 2 adults on hand for assembly-



- Do not assemble on flooring or carpet-



- Assemble on a clean non-marring surface (packing foam)-



- Save all packaging until finished-

Assembly Steps

Overview

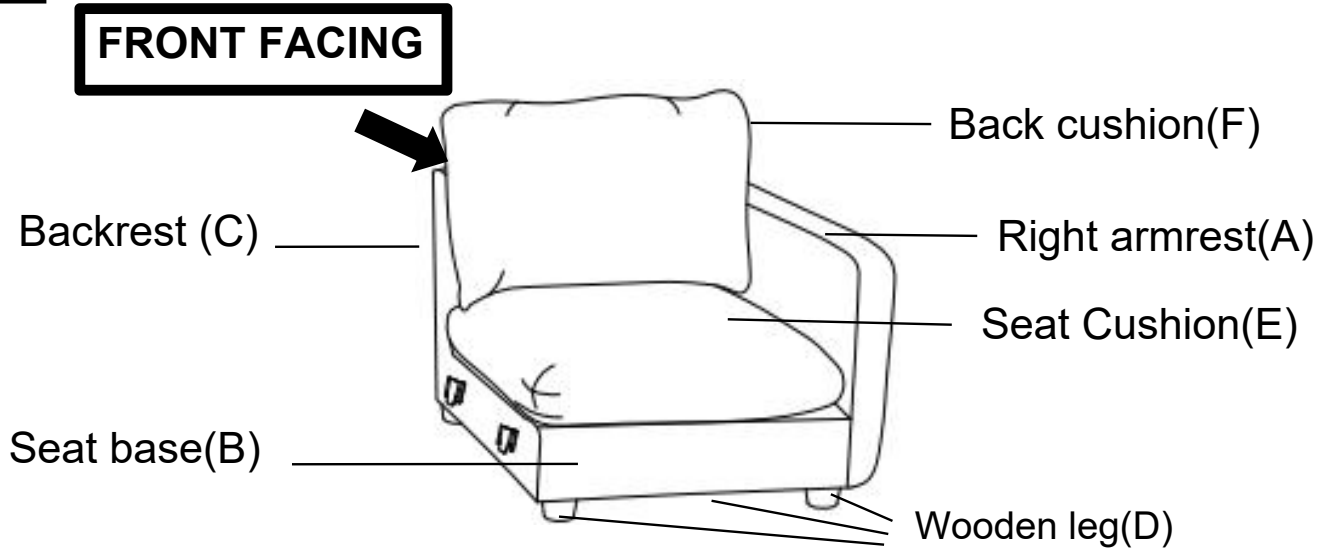

This Right Armchair has multiple parts and may require up to some 15 minutes to assemble. To give you an overview of the parts, the above picture is to help you put the various parts into perspective. Please read through the instructions below to familiarise yourself with the parts and steps before assembly.

Step 1

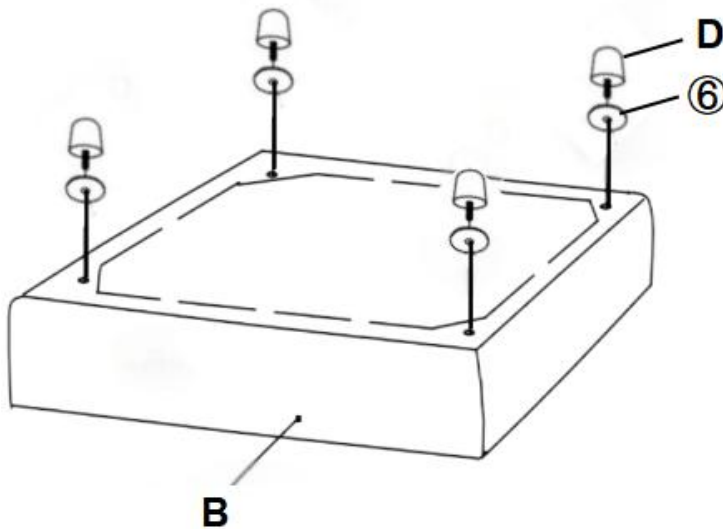

Assemble Wooden leg (D) and Plastic gasket(6) with Seat base (B) and rotate clockwise

Step 2

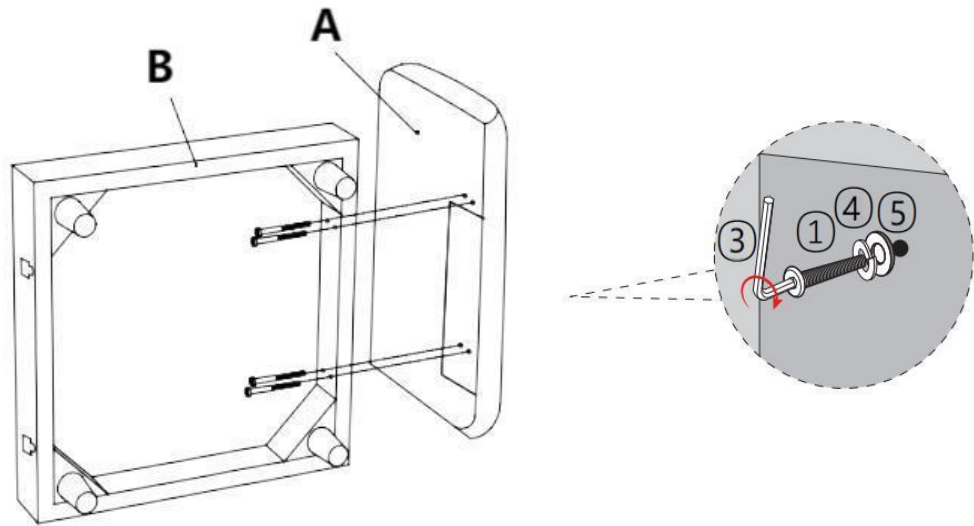

Place the Seat base(B) and the Left armrest(A) on the side, and then fix them together with Screws (①), Spring gasket (④), Gaskets (⑤), Allen wrench(③). There are a total of 4 Screws.

Step 3

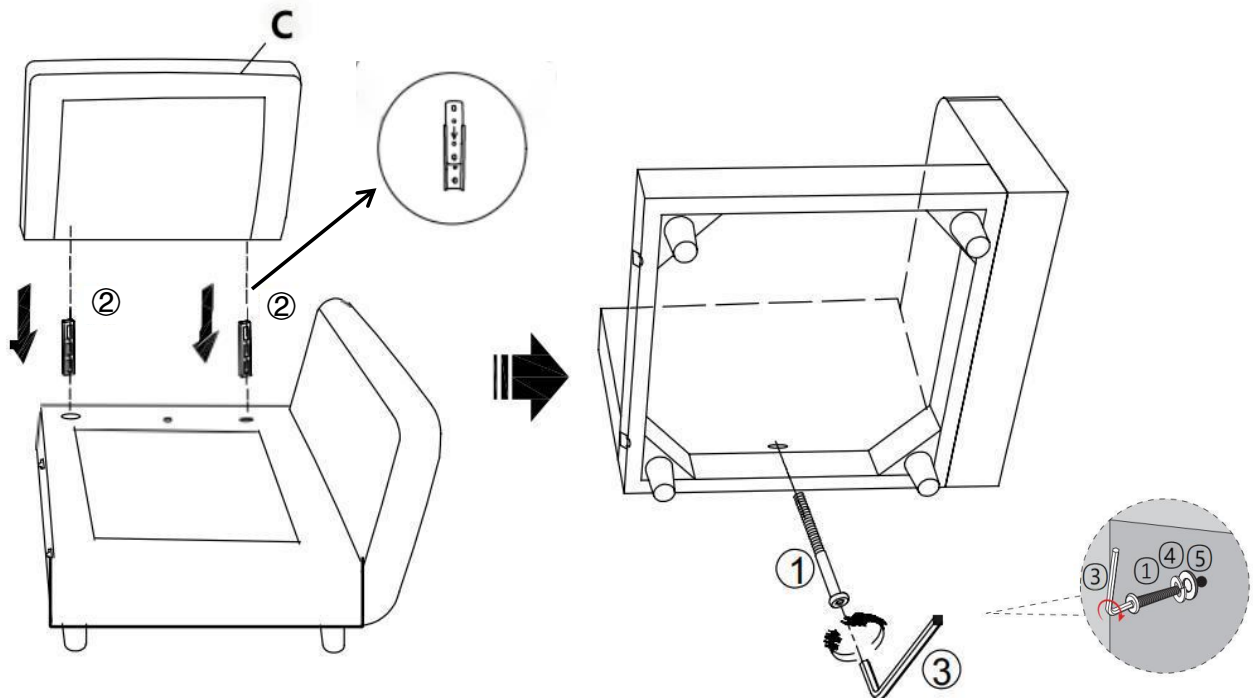

First, install the Connecting piece (②) on the Seat base (B), then install the Backrest (C) onto the Seat base (B) through the Connecting piece (②), and then place the Seat base (B) on the side. Use an Allen wrench(③) to tighten the Screw(①), Spring gasket (④), Gaskets (⑤) from the bottom.

Step 4

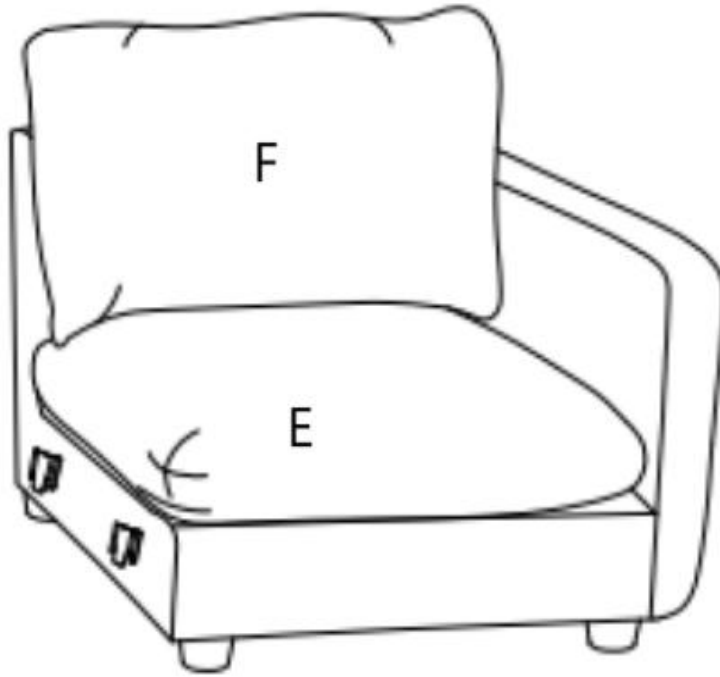

Unpack the Back cushion (F) and Seat cushion (E) (restore to their original state in 3 minutes), and arrange as shown above.

Step 5

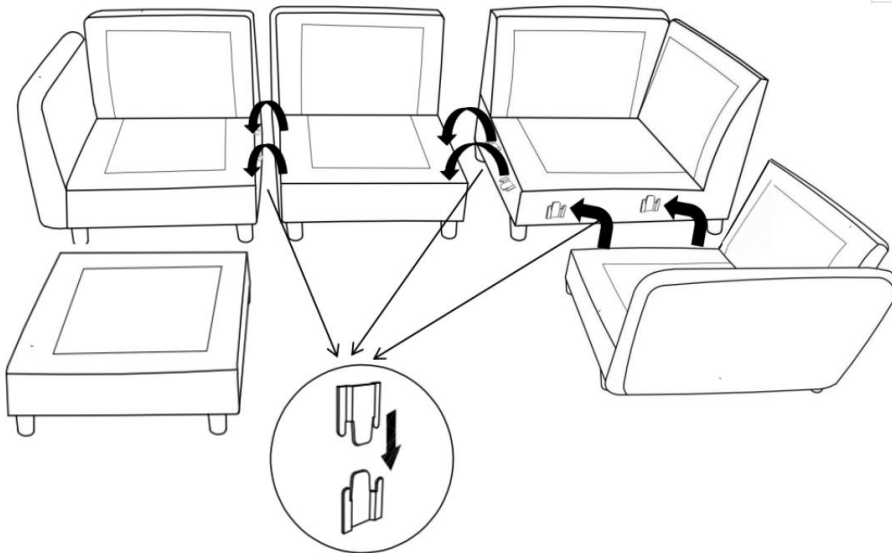

With the assistance of your adult partner, place the Chairs facedown and connect the chair using the installed mountain shaped insert.

Note: This is an optional step in case you want to connect all the Chairs in the set together and should be performed before affixing the cushions.

Questions & Answers about Proposition 65

- What is Proposition 65?

Proposition 65 requires businesses to provide warnings to Californians about significant exposures to chemicals that cause cancer, birth defects or other reproductive harm. These chemicals can be in the products that Californians purchase, in their homes or workplaces, or that are released into the environment. By requiring that this information be provided, Proposition 65 enables Californians to make informed decisions about their exposures to these chemicals.

Proposition 65 also prohibits California businesses from knowingly discharging significant amounts of listed chemicals into sources of drinking water.

Proposition 65 requires California to publish a list of chemicals known to cause cancer, birth defects or other reproductive harm. This list, which must be updated at least once a year, has grown to include approximately 900 chemicals since it was first published in 1987.

- What types of chemicals are on the Proposition 65 list?

The list contains a wide range of naturally occurring and synthetic chemicals that include additives or ingredients in pesticides, common household products, food, drugs, dyes, or solvents. Listed chemicals may also be used in manufacturing and construction, or they may be byproducts of chemical processes, such as motor vehicle exhaust.

- What does a warning mean?

If a warning is placed on a product label or posted or distributed at a workplace, a business, or in rental housing, the business issuing the warning is aware or believes that it is exposing individuals to one or more listed chemicals.

By law, a warning must be given for listed chemicals unless the exposure is low enough to pose no significant risk of cancer or is significantly below levels observed to cause birth defects or other reproductive harm.

- Where can I get more information on Proposition 65?

If you have specific questions on the administration or implementation of Proposition 65, you can contact OEHHA's Proposition 65 program at P65.Questions@oehha.ca.gov, or by phone at (916) 445-6900.