

John Deere S140 Lawn Tractor

Parts and Maintenance Information

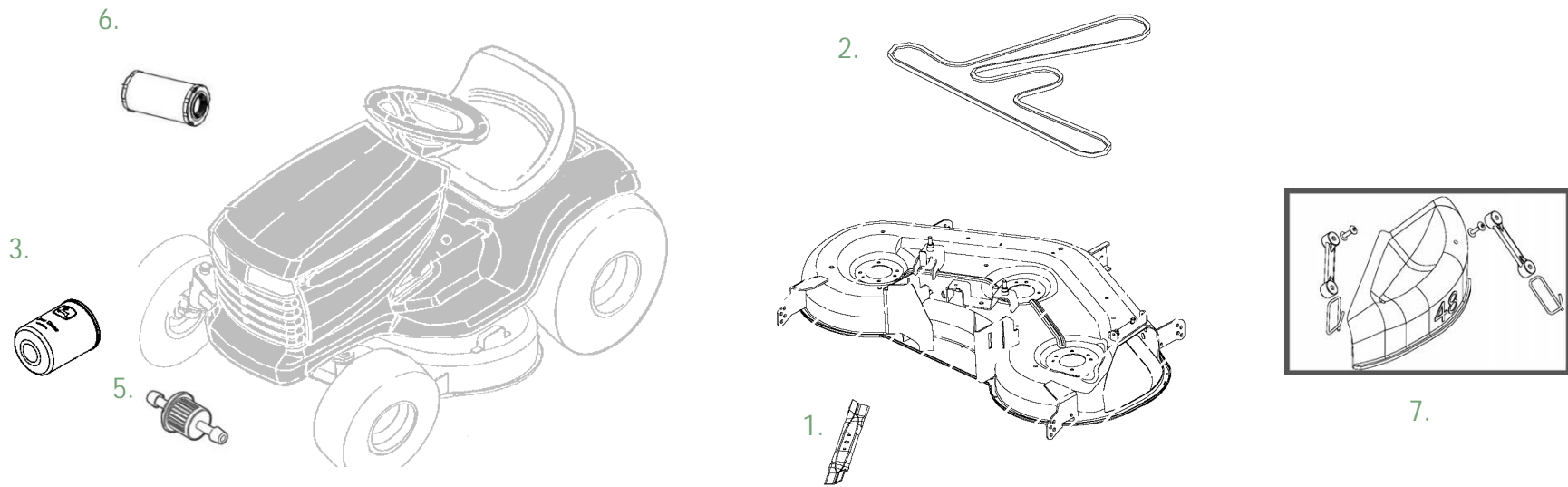

Key	Description	Part Number	Lowe's Item #
1.	48-inch Mower Blade (3-pack)	GY20852	228461
2.	48-inch Mower Deck Belt	GX21833	228875
3.	Oil Filter	GY20577	228877
4.	Oil	TY22029	48763
5.	Fuel Filter	GY20709	228878
6.	Air Filter	GY21435	336262
7.	Mulch Cover	GY20417	317781

John Deere S140 Lawn Tractor

Parts and Maintenance Information

- Service Intervals

After 8 Hours	Yearly or Every 50 Hours (Whichever Comes First)
Lubricate mower spindles and pivot points.	Change engine oil & replace filter. (Service more frequently under dusty conditions.)
Check mower deck spindle brakes (Manual PTO)	Clean/replace air filter precleaner & element. (Service more frequently under dusty conditions.)
Lubricate front axle pivot and axle spindles.	Replace fuel filter.
Lubricate front axle wheel bushings.	Sharpen/replace mower blades.
Every 25 Hours	Check/replace mower drive belt.
Lubricate mower spindles and pivot points.	Every 200 Hours
Lubricate front axle pivot and axle spindles.	Check/adjust valve clearance. See your John Deere dealer for this service.
Lubricate front axle wheel bushings.	

For complete parts information for 100 Series Tractors: Visit your local John Deere Dealer or www.Deere.com

*Refer to Operators Manual for a complete listing of service intervals.