

HOROW®

Installation & User Manual

HOROW T03-10

Smart Toilet

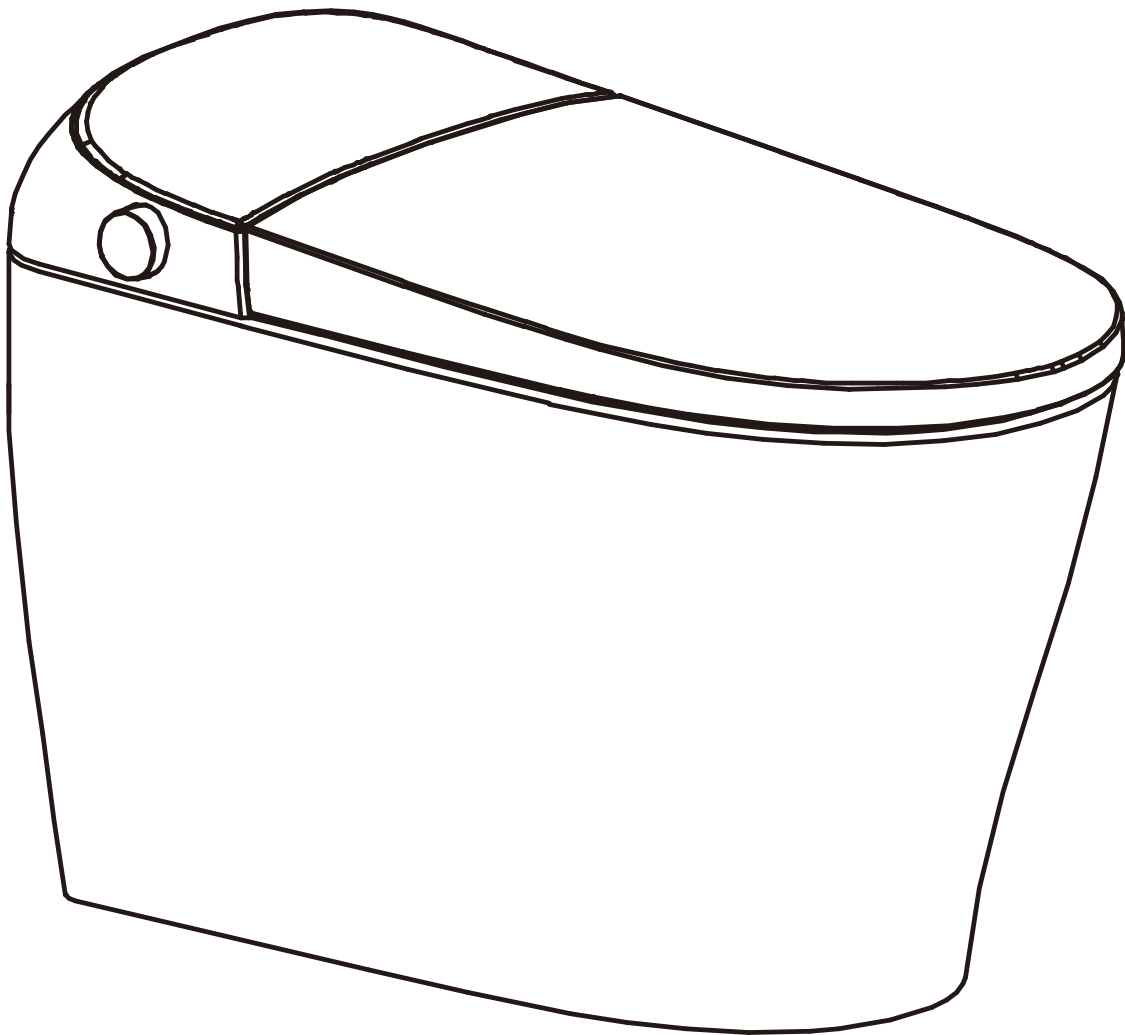

Contents

Important Safeguards	1
Important Information	1
Grounding Instructions	2
Explanation of Terms and Symbols	2
Overall Sketch	8
Function Table	9
Product Installation	10
Tools Needed for Installation	10
Parts Included	10
Prior to Installation	11
Installation of Smart Toilet	12
Installation of Battery Pack	15
Installation of Remote Control Holder	16
Product Test Run	17
Usage Instructions	18
Function Explanations	18
Knob Operations	20
Remote Control Operations	21
Daily Maintenance	23
Maintenance of Ceramics, Seat and Lid	24
Maintenance of the Nozzle	24
Maintenance During Winter Season	24
Troubleshooting	25
Specifications	27
Warranty	28

- Thank You for Choosing HOROW. Please read the instructions carefully before installation and keep it available for future maintenance or reference.
- We are not responsible for the accidents resulting from the user's negligence.
- HOROW reserves the right to make revisions to this manual without notice.



Need help? Contact HOROW Customer Service Team.

Phone: (+1)209-200-8033

Monday to Friday

Email: support@horow.com

Important Safeguards

Read All Instructions Before Using

Important Information

When using electrical products, especially when children are present, basic safety precautions should always be followed, including the following:



DANGER - To reduce the risk of electrocution:

1. Do not use while bathing.
2. Do not place or store product where it can fall or be pulled into a tub or sink.
3. Do not place in or drop into water or other liquid.
4. Do not reach for a product that has fallen into water. Unplug it immediately.
5. Do not wash the main unit or electrical plug with water or detergent.
6. During installation, disassembly, repair and maintenance of the product, the power plug must be switched off and the water supply be shut off.



WARNING - To reduce the risk of burns, electrocution, fire, or injury to persons:

1. Close supervision is necessary when this product is used by, on, or near children or invalids.
2. Use this product only for its intended use as described in this manual. Do not use attachments not recommended by HOROW.
3. Never operate this product if the cord or plug is damaged, if it is not working properly, or if it has been dropped, damaged, or immersed in water. If any of these conditions apply, contact our Customer Service Team directly.
4. Keep the cord away from heated surfaces.
5. Never block the air openings of the product or place it on a soft surface, such as a bed or couch, where the openings could be blocked. Ensure that the air openings remain free of lint, hair, and similar debris.
6. Never use while sleeping or drowsy.
7. Never drop or insert any object into any opening or hose.
8. Do not use outdoors or in environments where aerosol (spray) products are being used or oxygen is being administered.
9. Connect this product to a properly grounded outlet only. See **Grounding Instructions**.
10. Caution - Risk of electric shock. Do not remove the toilet lid (or back) on your own. Refer servicing to qualified service personnel.

Grounding Instructions





This product should be grounded. In the event of an electrical short circuit, grounding reduces the risk of electric shock by providing an escape wire for the electric current. The product is equipped with a cord that has a grounding wire and a grounding plug. The plug must be inserted into an outlet that is properly installed and grounded.

+	<p>DANGER - Improper use of the grounding plug can result in a risk of electric shock.</p> <ol style="list-style-type: none"> 1. If repair or replacement of the cord or plug is necessary, do not connect the grounding wire to either fat blade terminal. The wire within insulation having an outer surface that is green with or without yellow stripes is the grounding wire. 2. Check with a qualified electrician or serviceman if the grounding instructions are not completely understood, or if in doubt as to whether the product is properly grounded. 3. This product is factory equipped with a specific electric cord and plug to permit connection to a proper electric circuit. Make sure that the product is connected to an outlet having the same configuration as the plug. 4. No adapter should be used with this product. Do not modify the plug provided - if it will not fit the outlet, have the proper outlet installed by a qualified electrician. If the product must be reconnected for use on a different type of electric circuit, the reconnection should be made by qualified service personnel.
----------	---

Explanation of Terms and Symbols

To ensure proper and safe use of this product, please read this section carefully before use. After reading, store this manual in a safe place for any needed future reference.

The hazards and warnings listed herein are important to our user's safety. Significant consequences may result from failure to heed warnings. The company will not be held liable for any injuries or damages caused by improper use or failure to follow the safety instructions.

Warning	Indicate possible injury resulting from improper usage due to negligence of this sign.
Attention	Indicate human injury or property loss that may result from improper usage due to negligence of this sign.
	Indicate a strict request to follow noted precautions when used with the above "Warning" and "Attention" signs.
	Prohibit any individual from performing any action with this symbol.
	Prohibit any individual from dismantling product.
	Keep product away from any wet environments, including, but is not limited to, humid environments, close proximities to baths, showers or sinks.

 Do not touch!

 Do not touch with a wet hand!

 Keep away from any extreme heat or fire!

 Operate only as instructed!

 Pull out the power plug!

 Protective grounding.

Warning

This product needs to be properly grounded.

- ✘ Risk of electric shock.
- ✘ If unsure, contact an electrician.



Do not place a lit cigarette along with other burning objects into the unit.

- ✘ Risk of fire.



Do not touch, insert or pull out the power plug with a wet hand.

- ✘ Risk of electric shock.



Do not use during thunderstorms (pull out the power plug during storms).

- ✘ Failure in doing so may lead to injury or fault in the product.



Do not use a power socket in poor condition or a damaged power plug.

- ✘ Risk of fire and/or electric shock.

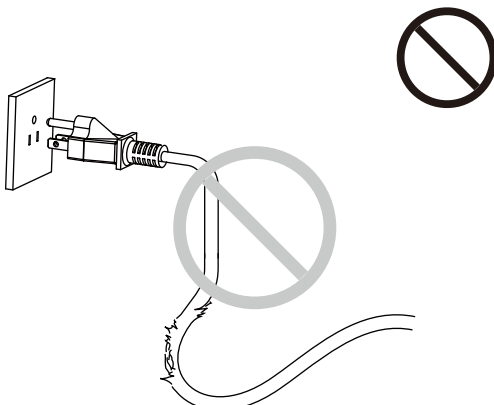

When the seat ring or the lid is damaged, to avoid any harm, be sure to pull off the power plug, close the water source and contact your local electrical installation company for replacement.

- ✘ Risk of fire and/or electric shock.



The power socket in use should be within the specified range.

※ Risk of fire and/or electric shock.

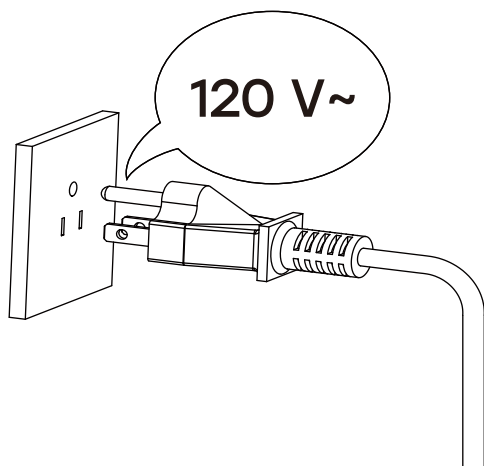

Regularly pull out the power plug and wipe off any dust on the power plug using a clean dry cloth.

※ Risk of fire.



Any person with a disability, the elderly, and children should be using this product with the supervision of another individual.

※ Be advised that sitting on the heated seat for an extended amount of time may result in burns.



Do not pull, damage, bend, twist, stretch, roll, bundle, clamp or squeeze the cord. Do not place anything on the cord.

※ Risk of fire and/or electric shock.



This product is not a toy. Advise children not to play with product.

※ Risk of injury.



If the power cord is damaged, to prevent any injuries or accidents, it should be replaced by a professional.

※ Risk of fire and/or electric shock.



Do not dismantle, repair or alter this product on your own. Call in a professional for further advice.

※ Risk of fire, electric shock, and/or other accident that may lead to injury.



For cleaning or maintenance of plastic parts, do not use any harsh cleaning agents. (These include, but are not limited to products such as concentrated sulfuric acid, concentrated nitric acid, glacial acetic acid, carbon tetrachloride, chloroform, benzene, phenol, methylphenol, dimethylformamide, methyl ether, soybean oil, acetate, 40% nitric acid, thick salt acid, 95% alcohol, gasoline, kerosene, etc.)

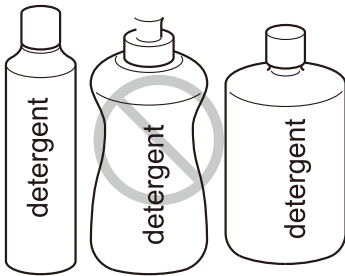

※ Risk of damaging parts that can lead to accidents and injuries.

Do not use polluted water or water meant for industrial use.



- ※ Risk of cystitis and dermatitis.
- ※ Untreated water may also cause internal corrosion of the product and may cause electrical shock or a fire.

Do not apply any force to the unit's seat and lid. Do not stand on the lid or open or close the lid and the seat forcefully.

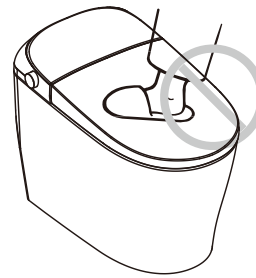

※ Risk of product damage and/or user injury.

Do not add water or detergent into the unit or onto the wireless remote control. Do not soak the product with water or cleaner.



※ Risk of fire and/or electric shock.

Do not place your hand or any other object into the dryer trap, and do not cover the dryer and dryer trap during product use.

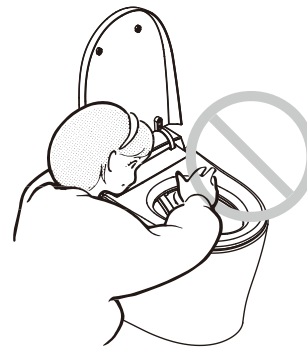

※ Risk of fire, electric shock and/or other accident that may lead to user injury.

Do not install the product in a humid environment or a soaked room. Do not spray or soak this product with any form of liquid to prevent any damage to the product.



※ Risk of fire, electric shock, and/or other accident that may lead to user injury.

Do not spray urine at the dryer.



※ Risk of electric shock.

 **Battery Warning**

Read the following for proper battery usage.

- ① Properly install the battery according to its correct polarity.
- ② Remove the battery during long periods without use.
- ③ Replace the battery in time.
 - ✘ Failure to do so may result in interrupted control signals.
- ④ Cover the battery with tape before disposal. This will prevent battery fluid leaks that may cause fire and/or other damages.
- ⑤ Place the battery out of children and infant reach.
 - ✘ If battery is swallowed, contact a doctor immediately.
- ⑥ If battery fluid leaks onto user, quickly rinse off using clean water.
- ⑦ If battery fluid gets into eyes, do not rub your eyes. Quickly rinse it with clean water and consult a doctor immediately.
 - ✘ Failure to do so may result in vision impairment or blindness.

**When the battery is in use, do not do the following operations:**

- ① Do not hold or store with metal objects (such as a necklace or a watch).
- ② Do not mix new and old batteries.
- ③ Do not pull apart battery or throw it into water and/or fire. Battery fluids may cause a fire.



 **Attention**

Do not use the heated seat or warm dryer temperature for an extended amount of time.

- ※ Extended use may result in burns.



Avoid direct sunlight or heat.

- ※ Risk of product discoloration.



While using this product, make sure that the skin is in contact with the seat sensor area. Otherwise, the product may not operate correctly.

- ※ Children and smaller individuals may have trouble staying in contact with sensor area.



Do not spray urine in the direction of the bidet nozzle.

- ※ Doing so may result in blockage to the bidet nozzles and cleaning area.



Do not supply electricity with an external switch, i.e., connecting the universal part to a timer switch.

- ※ Risk of problems caused by improperly resetting the thermal breaker.



Pull out the power plug when the product is in disuse for an extended amount of time. Make sure to shut off the water and remove the water inside the product.

- ※ Risk of fire, leakage and product damage.



When storing or transporting in cold climate, make sure to remove all water from the unit. Product may crack and other damages may occur due to freezing water.

- ※ Risk of fire, leakage and product damage.



In case of sudden power failure, pull out the power plug and turn off the angle valve to prevent water leakage.

- ※ Risk of water leakage and/or property loss.



Overall Sketch

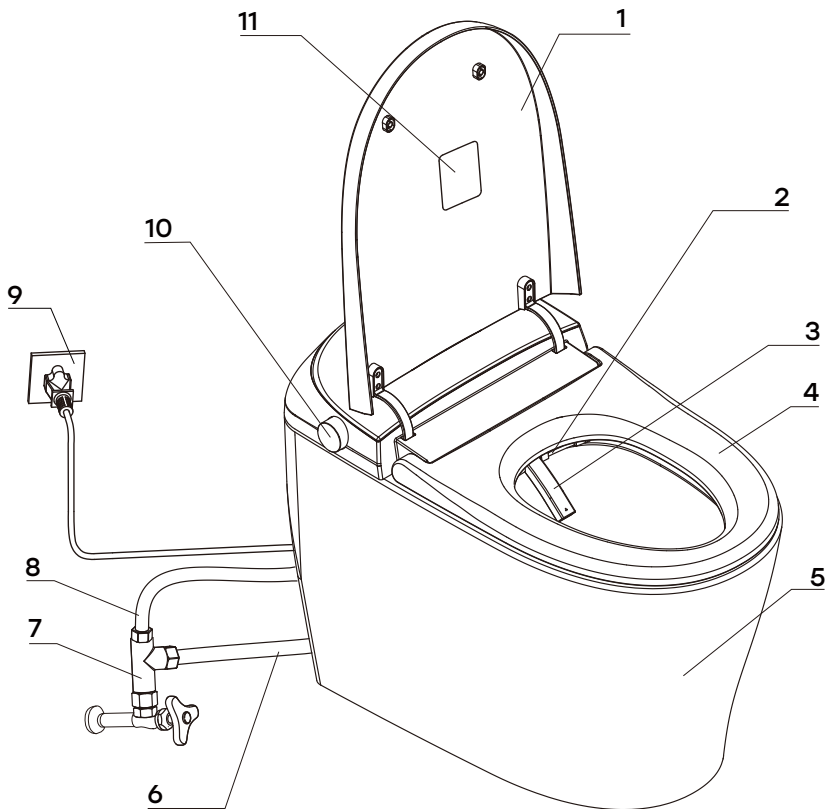

1	Lid
2	Warm Dryer
3	Detachable Nozzle
4	Heated Seat
5	Ceramic Toilet Bowl
6	Flush Water Hose
7	T-valve
8	Clean Water Hose
9	Power Plug
10	Knob
11	Caution

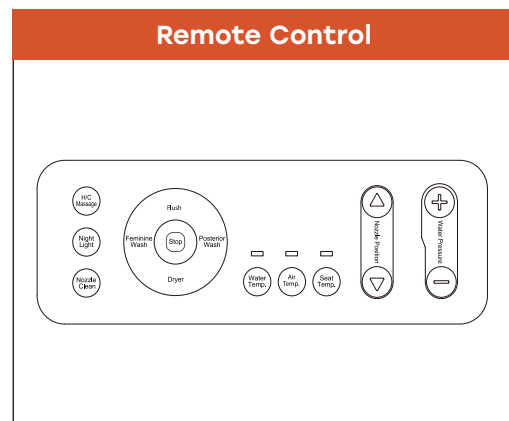
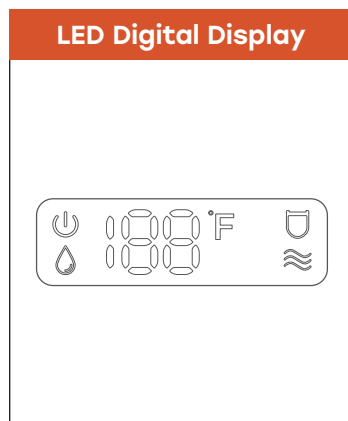
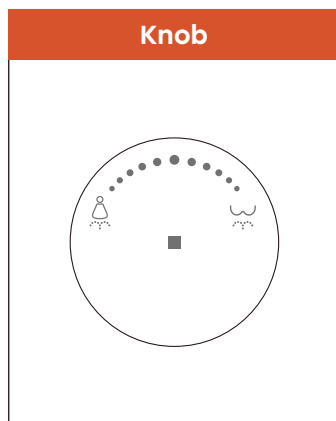

※ Two AAA batteries for the remote control are included in the product package.

Function Table

Category	Model	
	Functions	T03-10
Hygiene	Feminine Wash	●
	Posterior Wash	●
	Movement Wash	●
	H/C Massage	●
	Self-cleaning Nozzle	●
	Detachable Nozzle	●
	Nozzle Clean	●
	Anti-bacterial Seat	●
	Easy-clean Glaze	●
	Pre-wet	●
Comfort	Instant Heating	●
	Adjustable Water Temperature	●
	Adjustable Water Pressure	●
	Bubble Wash (Water & Air Mixed)	●
	Adjustable Nozzle Position	●
	Heated Seat	●
	Adjustable Seat Temperature	●
	Warm Dryer	●
	Adjustable Dryer Temperature	●
	Auto Deodorization	●
Convenience	Auto Wash	●
	Auto Flush	●
	Drying Flush	●
	Blackout Flush	●
	Remote Flush	●
	LED Digital Display	●
	Night Light	●
	Energy-saving Mode	●
	Soft Close	●
	Factory Data Reset	●
Safety	SUS Filter	●
	Air Isolation & Backflow Prevention	●
	Multiple Protections	●
	Fire and Heat Resistant	●

Note:

The blackout flush battery pack for power outage is not included and must be purchased separately. If you want to purchase the battery pack, please contact our Customer Service Team.

Product Installation





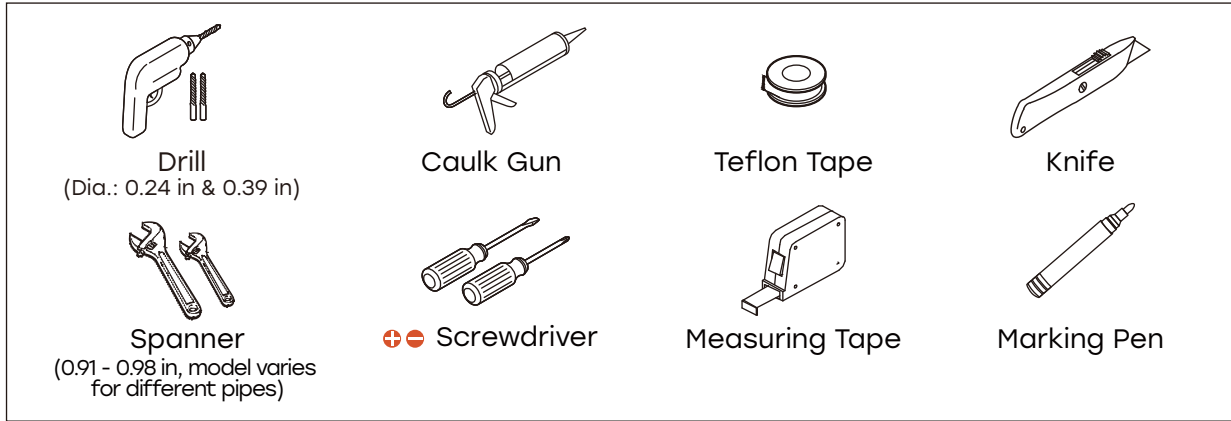





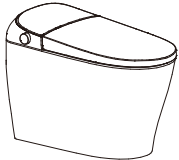
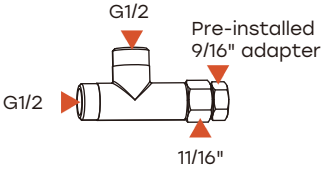
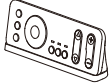
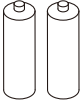
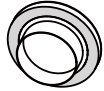
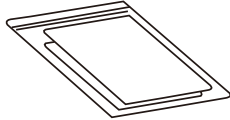
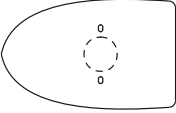
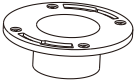













Tools Needed for Installation

Please have these tools prepared prior to installation.



Parts Included

Please confirm that all items below are inside the box.

<p>Smart Toilet (1 pc)</p> 	<p>T-valve (1 pc)</p> 	<p>Remote Control Set (1 pc)</p>  <p>(holder 1 pc, screw 2 pcs)</p>									
<p>Two AAA Batteries</p> 	<p>Wax Ring (1 pc)</p> 	<p>Installation & User Manual</p> 									
<p>Installation Template (1 pc)</p> 	<p>Floor Flange (1 pc)</p> 										
<p>Mounting Accessory Kit:</p> <table border="0"> <tr> <td> Expansion Bolt (8 pcs)</td> <td> Mounting Block (2 pcs)</td> <td> Fixing Sleeve (2 pcs)</td> </tr> <tr> <td> Screw (4 pcs)</td> <td> Hexagon Screw (4 pcs)</td> <td> Toilet Screw (2 pcs)</td> </tr> <tr> <td> Decorative Cap (2 pcs)</td> <td> Washer (8 pcs)</td> <td></td> </tr> </table>			 Expansion Bolt (8 pcs)	 Mounting Block (2 pcs)	 Fixing Sleeve (2 pcs)	 Screw (4 pcs)	 Hexagon Screw (4 pcs)	 Toilet Screw (2 pcs)	 Decorative Cap (2 pcs)	 Washer (8 pcs)	
 Expansion Bolt (8 pcs)	 Mounting Block (2 pcs)	 Fixing Sleeve (2 pcs)									
 Screw (4 pcs)	 Hexagon Screw (4 pcs)	 Toilet Screw (2 pcs)									
 Decorative Cap (2 pcs)	 Washer (8 pcs)										

Prior to Installation

Please confirm that all the aforementioned items in the package are present. In case of any missing parts, please feel free to contact our Customer Service Team. Illustrations above are for reference only. The ceramic product may have slight deformation during the firing process. Please consult the actual product for accurate details.

Verify the product dimensions and secure enough installation space. The rough-in size refers to the distance between the center of the toilet flange to the finished back wall.

※ All dimensions are manually measured with a certain degree of error. For the specific size, please refer to the actual product received.

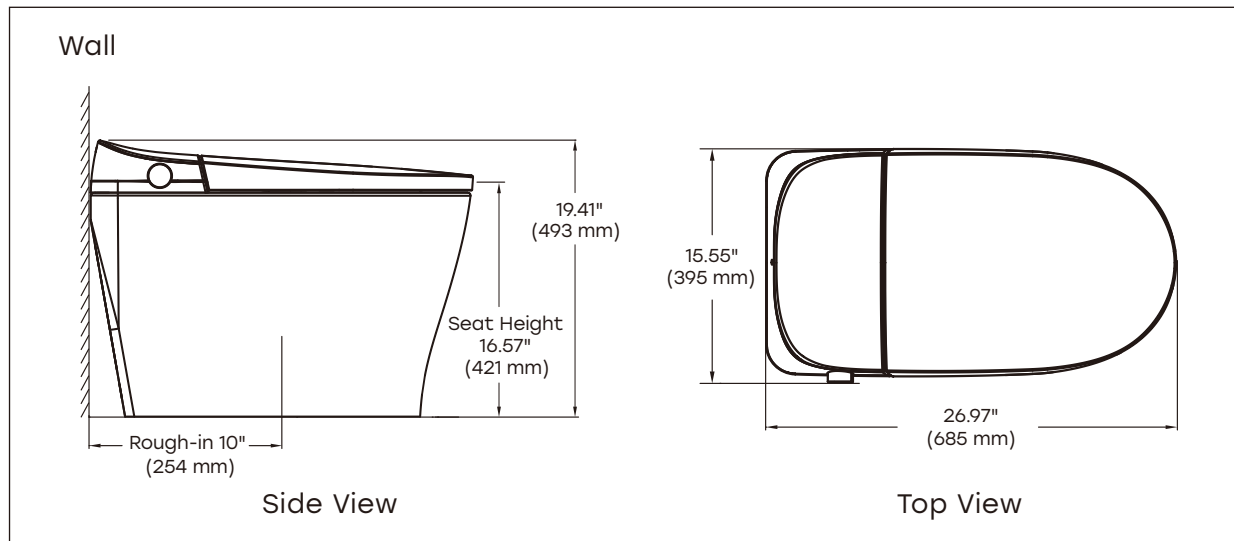

To ensure proper installation, the distance between the water supply valve and the centerline of the toilet should be greater than half the width of the toilet bottom. The water supply valve should be about 8 inches away from the toilet centerline. For larger valves, a greater distance may be necessary to ensure proper clearance. For easy installation and maintenance, a range of 9 to 11 inches is recommended.

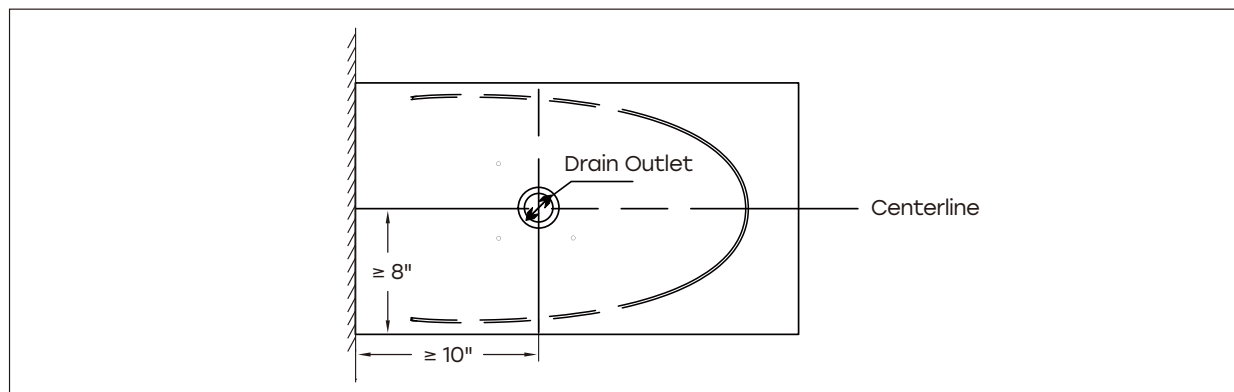

The minimum water pressure required is 11.6 psi, and the maximum water pressure is 108 psi. If the minimum water pressure is not met, the smart toilet may not achieve the optimal cleaning performance. However, since the product includes a built-in water tank and pump, its ceramic scouring effect is not affected by external water flow, pressure, or other environmental factors.

Electrical requirements for this product: 16 Amps at AC 120 V, 60 Hz.

Installation of Smart Toilet

Install your toilet using the following steps:

Please remove the old toilet first if any and ensure the mounting surface is clean and level before the new toilet is installed.

1 Open the box right side up

Remove the accessories first, then lift the toilet with two people, remove the packaging, and gently place the toilet on the floor, as shown in the diagrams below.

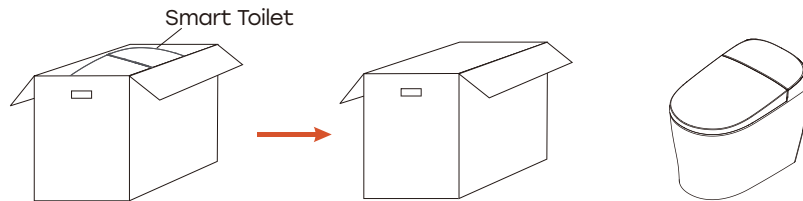

2 Install with installation template

Align the installation template with the centerline of drain outlet.

Mark eight mounting holes on the ground based on the installation template with the marking pen: four for the flange and four for the mounting blocks. Then, outline the edges of the template to mark the toilet placement for later installation.

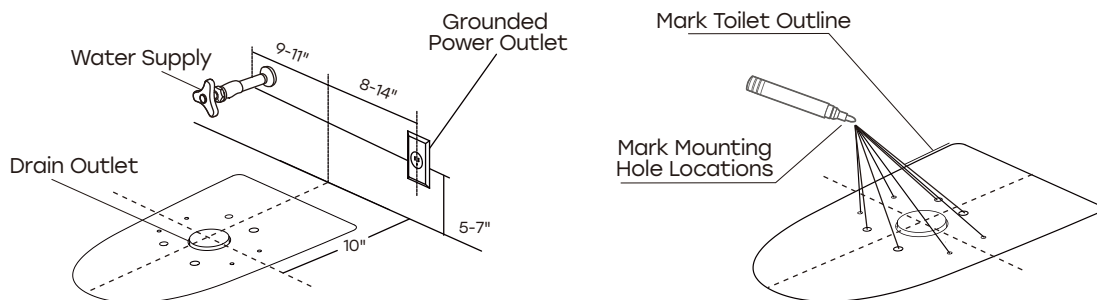

3 Install and fix the flange

Drill eight 0.39-in (10 mm) holes at the locations marked in previous step. Insert eight expansion bolts into eight holes. Position the flange on the drain pipe outlet, aligning the four flange holes with the four holes drilled in the ground. Next, insert the washers and screws into the holes of the flange and tighten them using a screwdriver.

※ If an applicable flange is already in place, there is no need to install the new one.

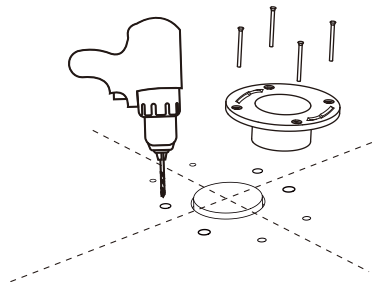

4 Install the mounting blocks

Position the two mounting blocks next to the flange, ensuring each block aligns with the previously marked mounting holes. Insert the washers and hexagon screws into the holes of the mounting blocks and tighten them using a screwdriver.

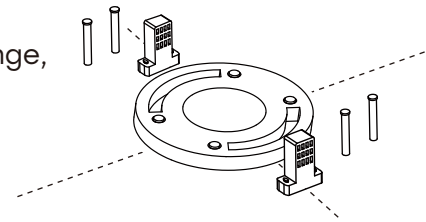
**5 Install the ceramic toilet**

Install the wax ring onto the drain hole at the bottom of the ceramic toilet and press it firmly into place.

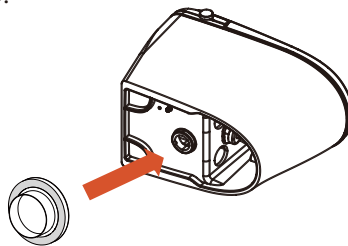

Lift the ceramic toilet with two people and gently lower it onto the flange, letting it well fit the mounting blocks.

Press down firmly on the ceramic toilet to ensure the wax ring forms a complete seal.

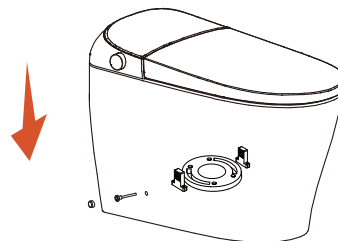

Insert the screw through the fixing sleeve, then through the holes on both sides of the ceramic toilet and into the mounting blocks on the ground. Tighten them securely using a screwdriver.

Put the decorative cap onto the fixing sleeve.

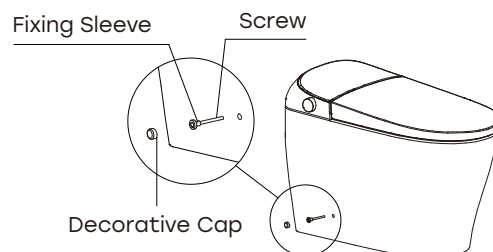
**Tips:**

- ※ The toilet is heavy, and it needs two people to carry it.
- ※ Please clean the drain outlet.
- ※ Please make sure ceramic toilet outlet sits perfectly on the drain outlet.

6 Install the T-valve and water hoses

Connect the T-valve to the water supply (Available in 9/16" adapter). Use Teflon tape on all threaded connections to ensure a water tight seal. Use gasket to prevent water leakage.

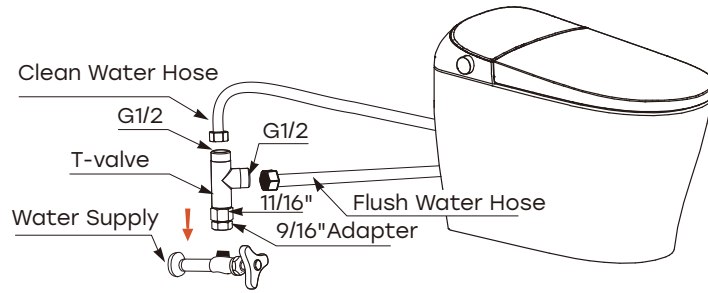

Note:

If your water valve is 9/16", you could directly connect the T-valve; If your water valve is 11/16", please screw off the adapter, then connect it.

Connect the flush water hose to the T-valve and tighten it.

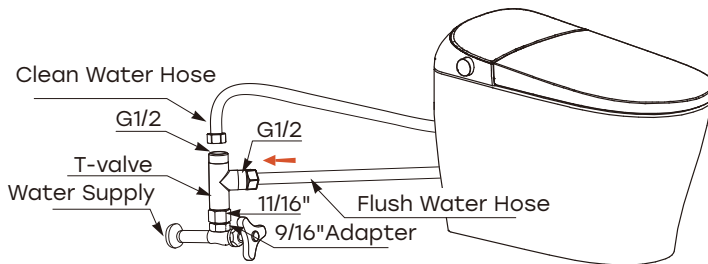

Connect the clean water hose to the T-valve and tighten it.

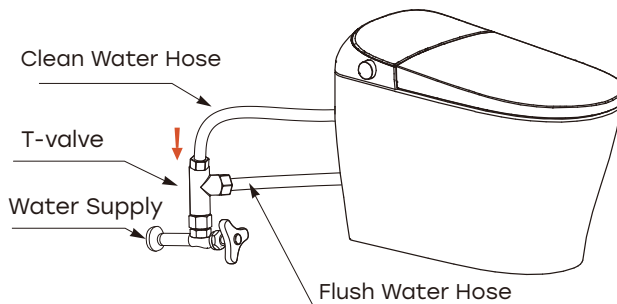

Installation of Battery Pack

The battery pack is primarily used for blackout flush in case of a power outage. It provides emergency power to the toilet and needs to be purchased separately. For any questions, please contact Customer Service Team.



Install the external battery pack

Locate and hold the connecting cable at the position where indicated. Remove the protective cap from the connecting cable.

Insert the waterproof DC power plug of the battery pack into the connecting cable and tighten the waterproof cap securely. Place the battery pack in an appropriate location as shown below.

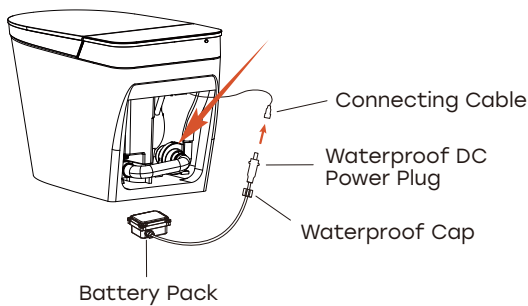

- ※ The battery should be placed out of the reach of children.
- ※ Some batteries and connecting cables may have slots. Please do not forcibly insert, otherwise, it will lead to product damage.

Replace the external battery pack

Unscrew the waterproof cap at the connection of the waterproof DC power plug.

Pull out the waterproof DC power plug.

Replace the battery pack with a new one, which can be used after installation.

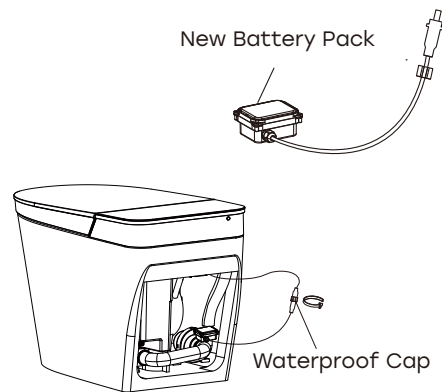

- ※ The battery pack for blackout flush has an IPX6 waterproof rating. A single battery pack can support approximately 200 flushes during a power outage. Please note that the battery naturally degrades over time, even when not in use.

Installation of Remote Control Holder



Drill two 0.24-in (6 mm) holes in the wall (about 1.77 inches deep).

Knock the anchors into the hole with a hammer.

Secure the holder with anchors.

Use the screws to secure the holder to the wall.

Remove the battery cover from the backside of the remote control to install batteries.

Once finished, the remote control is ready to be placed in its holder.

Detailed steps are shown in the diagrams below:

- ※ Please use proper mounting tools for special wall surfaces (such as wood, HDF, etc.)
- ※ The remote control holder should be installed away from the bidet's spray trajectory.
- ※ The remote control holder should be installed within reach when seated on the toilet.
- ※ Make sure there is nothing to block the transmission between the toilet and its remote control.

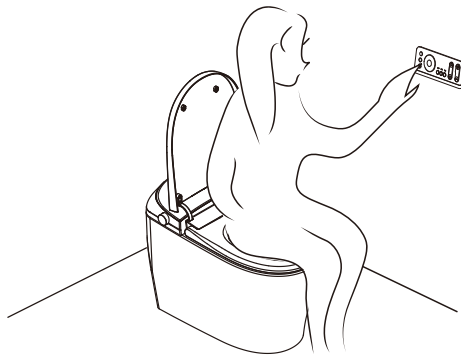

Steps:

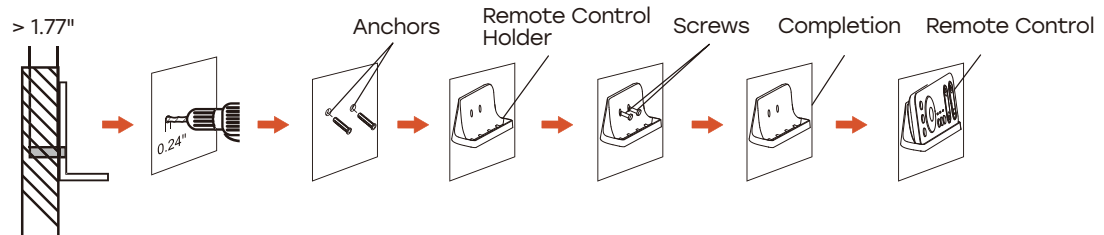

Product Test Run

1

Water Connection

Turn the water supply angle valve to the maximum opening, as shown in the diagram. Make sure no leakage is found at various connection parts.

※ In case of any water leakage, unfasten the nuts and install them again.

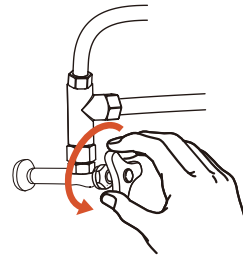

2

Power Connection

Ensure the electrical requirements are met: 16 A at AC 120 V, 60 Hz. Plug the power plug into AC 120 V socket. Press the knob on the toilet to start a flush and confirm the toilet is powered on.

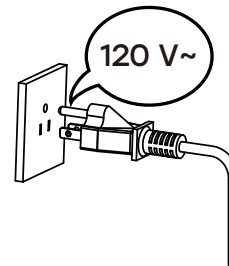

3

Smart Toilet Running

Are all functions working properly?

Test all function buttons on the remote control and the knob on the toilet.

Verify the normal operation of each function.

Operate the remote control and confirm the functionality of Posterior Wash, Feminine Wash (including water pressure and nozzle position adjustment), Warm Dryer, Air Temperature and Water Temperature Adjustment, Nozzle Clean and Night Light.

All functions listed above should be tested. Please ensure all specified functions run correctly. Posterior wash, feminine wash and warm air drying functions should be tested while the seat is occupied.

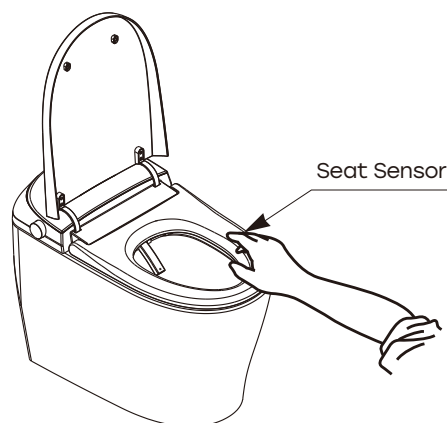

After the toilet is installed and the test run is completed, it is recommended that you apply the silicone sealant around the base of the toilet. Please avoid applying sealant where the access covers meet the floor.

Usage Instructions

Function Explanations



Auto Flush

The toilet will automatically flush after the seat sensor no longer detects a user if no flush is performed during seat occupancy.



Drying Flush

Press **Dryer** on the remote control to activate the dryer to blow warm air. If no flush is executed after posterior or feminine wash, a flush will be performed automatically to eliminate unpleasant odors before the dryer is activated. Posterior/feminine wash is not available during the flush process.

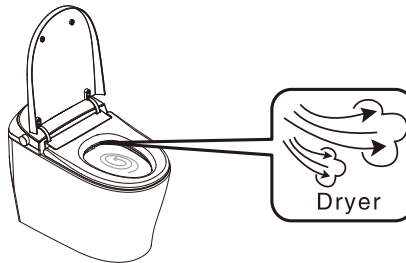

Blackout Flush

Blackout flush refers to the manual emergency flush during a power outage. Press the knob to activate blackout flush. If the above operation does not work properly, you need to replace the battery or contact our Customer Service Team.

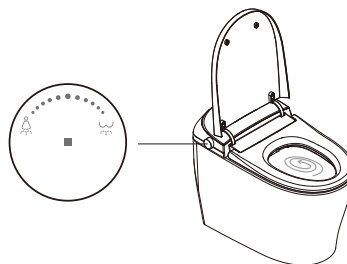

**LED Digital Display**

When different functions are activated, the corresponding function animation is displayed or the indicator light is on.

The  icon indicates that the power indicator light is on.

The  icon indicates the cleaning water temperature.

The  icon indicates the seat temperature.

The  icon indicates the warm air temperature.

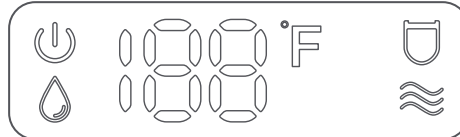
**Auto Deodorization**

The deodorization function will be activated automatically when the seat is occupied and will be turned off 3 minutes after the seat is unoccupied.

A deodorizer device is installed at the back of the toilet to help eliminate unpleasant odors and improve ventilation.

**User-friendly Design****① Pre-wet**

When the toilet seat is occupied, the product will flush automatically once towards the seat to moisten the toilet bowl.

② Multiple Protections

Multiple built-in safety features are designed to protect both the user and the product.

③ Memory Mode

The toilet automatically remembers and retains the last-used settings, including water temperature, seat temperature, warm air temperature, nozzle position and other user preferences. Such settings will revert to factory defaults in the event of a power failure.

④ Antibacterial Seat

The seat is made of antibacterial material to ensure enhanced hygiene.

⑤ Energy-saving Mode

When enabled, the toilet conserves energy by maintaining the heated seat temperature at 86 °F when not in use.

Knob Operations



Power/Stop

When the toilet is powered on and no one is seated, press and hold the knob for 3 seconds to enter the standby mode.

When the toilet is in standby mode, press and hold the knob for 3 seconds to activate it.

When the toilet is powered on and seated, press and hold the knob for 3 seconds to enter the drying mode.

When the toilet is in feminine/posterior wash or drying mode, press the knob to stop the function.

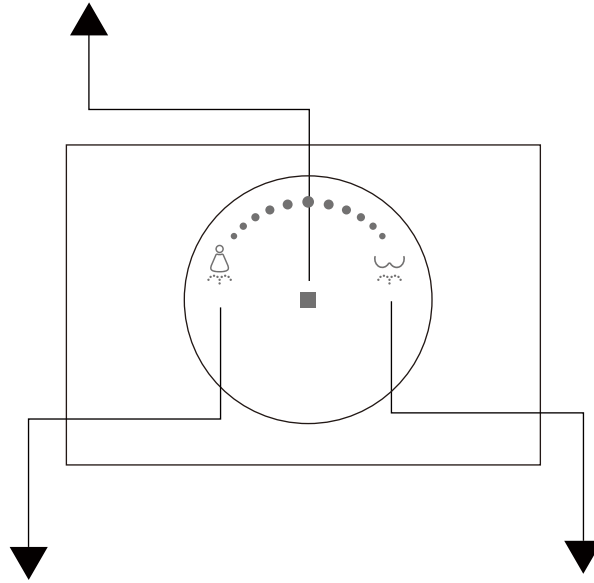

Feminine

Rotate counterclockwise

When the seat is occupied and the toilet is not in wash or drying mode, rotate the knob counterclockwise to start the smart feminine wash cycle. Movement wash is provided by default. The entire process includes feminine wash, auto flush and warm air drying, taking approximately 5.5 minutes.

During a feminine wash, rotate the knob clockwise to increase the cleaning intensity, and counterclockwise to decrease it.

Posterior

Rotate clockwise

When the seat is occupied and the toilet is not in wash or drying mode, rotate the knob clockwise to start the smart posterior wash cycle. Movement wash is provided by default.

The entire process includes posterior wash, auto flush and warm air drying, taking approximately 5.5 minutes.

During a posterior wash, rotate the knob clockwise to increase the cleaning intensity, and counterclockwise to decrease it.

- ※ When the seat is unoccupied and the toilet is not in use, press the knob to immediately flush the toilet.
- ※ When the seat is unoccupied and the toilet is not in use, press and hold the knob clockwise to enable/disable the auto deodorization function. (A short beep indicates that the function has been enabled, while 2 short beeps indicate that the function has been disabled.)

Remote Control Operations

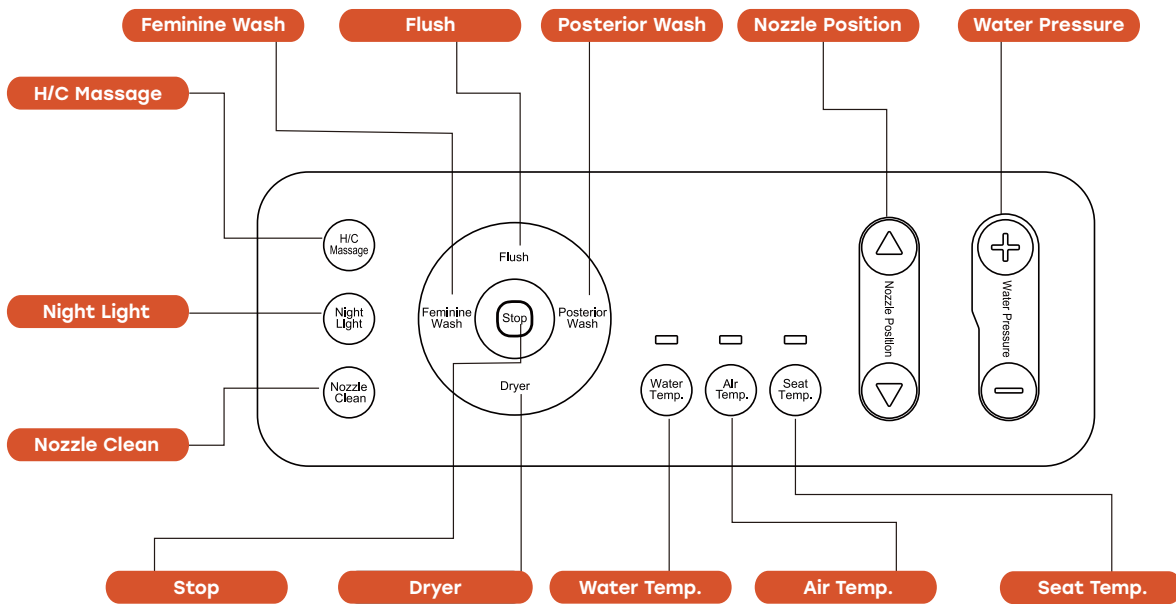

Press **Flush** to flush the toilet after use.

Press **Posterior Wash** to start posterior cleaning. Movement wash is provided by default. Press again to stop movement wash and return to posterior wash. It will stop after approximately 4 minutes.

Press **Feminine Wash** to start feminine cleaning. Movement wash is provided by default. Press again to stop movement wash and return to feminine wash. It will stop after approximately 4 minutes.

Press **Dryer** to dry off the water after using the wash function. It will stop after approximately 4 minutes.

Press **Stop** to stop any activated wash functions (posterior wash or feminine wash) or the dryer. Press **H/C Massage** to switch between warm and cold water washing during any wash process.

Press **Night Light** to turn the night light on or off.

Press **Nozzle Clean** to extend the nozzle out while unseated, allowing the user to easily detach and clean it manually.

Press **Water Temp.** to adjust the water temperature for any wash function.

Press **Air Temp.** to adjust the warm air temperature of the dryer during drying.

Press **Seat Temp.** to adjust the heated seat temperature while seated.

Press **Nozzle Position** to adjust the nozzle position.

Press **Water Pressure** to adjust the cleaning intensity of feminine wash and posterior wash.

• Other Settings

Note: The following automatic functions are enabled by default from the factory, with the exception of the energy-saving mode. To make adjustments, please follow the steps below to enable or disable these functions.

A short beep indicates that the function has been enabled, while 2 short beeps indicate that the function has been disabled.

Press and hold **H/C Massage** and **Flush** simultaneously for 3 seconds to enable/disable the buzzer.

※ When disabled, no audio prompts will be heard during knob and remote control operations.

Press and hold **Seat Temp.** and **Flush** simultaneously for 3 seconds to enable/disable the pre-wet function.

Press and hold **Night Light** for 3 seconds to enable/disable the energy-saving mode.

※ When enabled, the toilet conserves energy by maintaining the heated seat temperature at 86°F when not in use. Once seated, the seat returns to the preset temperature (Except for High Level, which will be heated to 98.6°F).

Press and hold **Flush** for 3 seconds to enable/disable the auto flush function.

Code Pairing of Remote Control

The remote control is pre-paired with the smart toilet at the factory for immediate use. However, if the remote control isn't functioning properly, or if you own multiple toilets of the same brand and experience interference when operating them, you can manually pair the remote control with the toilet.



Unplug the toilet. Press and hold **Stop** for a few seconds until three level lights flicker.

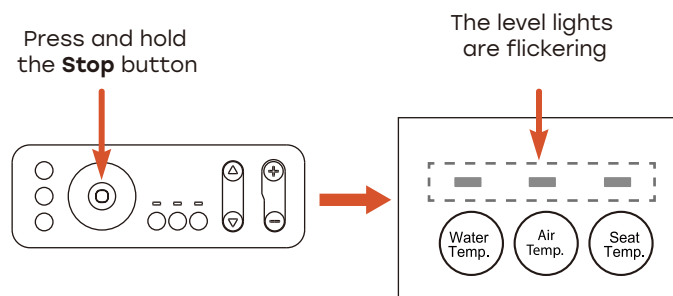

Place the remote control near the product and plug the attaching plug.

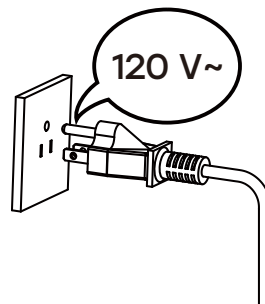



The level lights stop flickering, and then they are lighted on. Codes are paired successfully when all lights are on.

All the level lights
are normally on

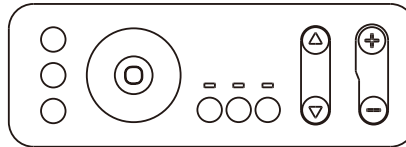

Daily Maintenance

Regular maintenance is required to ensure normal use.



Note:

1. Cut off the power and water supply before maintenance.
2. Direct water wash to the entire product is prohibited.



Warning:

Do not spray water or detergents on the toilet, remote control or the power cord. Doing so may cause electric shock or fire.

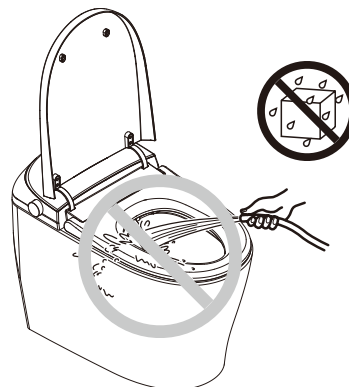

Maintenance of Ceramics, Seat and Lid



1. Wipe dust or stains with a soft wet cloth.
2. A wet soft brush, cloth, or sponge may be used to clean the ceramic area.

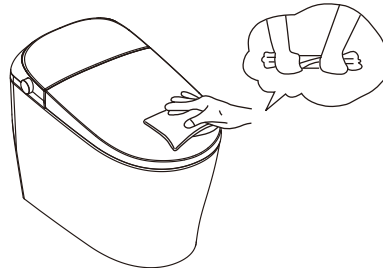

- ※ Do not use abrasive cleaners, such as alcohol, bleach, painter thinner, cresol, benzene, gasoline, etc.

Maintenance of the Nozzle



Press **Nozzle Clean** button on the remote control without occupying the seat when the toilet is powered on. The nozzle will extend out. Proceed to clean it with a soft toothbrush. The nozzle can be disassembled to clean. Press **Nozzle Clean** button again, and the nozzle will return to the original position.

- ※ Do not forcefully hold the nozzle, otherwise it may break.
- ※ Please replace the spout with a new one if it is clogged.

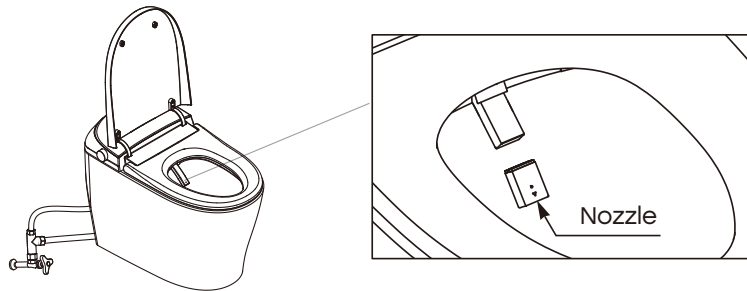

Maintenance During Winter Season

During the winter season, the water inside may freeze after long periods of storage and non-use. Please take measures to prevent.



Note:

1. Before connecting the product to the water supply and electrical outlet, allow it to defrost for 30 minutes in a warm indoor environment.
2. In cases of extreme cold/freezing/nozzle stuck in place, wrap the water input line with a warm towel. Never pour hot water or use a hot dryer directly on the toilet.

Troubleshooting

This Troubleshooting Guide is for general aid only. If the user encounters any problems, please first consult the troubleshooting guide below. If the problem persists, please contact our Customer Service Team.



Scan the QR code for video resources and find the troubleshooting videos you need.

Power Button		
Phenomenon	Fault Diagnoses	Solutions
Not working	Check whether the attaching plug is loose or not	Please check the circuit
	Check whether the power is switching on or off (the power light is not on)	Press and hold the knob, the power light is on
	Check whether there is any electric leakage or not	Unplug the attaching plug from the socket, plug it again later, if it is still not working, please unplug the attaching plug and contact our Customer Service Team
Wash Functions		
Phenomenon	Fault Diagnoses	Solutions
No water from the spout	Check whether the water supply cuts off or not	Wait for the water supply restoring
	Check whether the angle valve switches off or not	Open the angle valve
	Check whether the water filter is blocked or not	Clean the filter mesh or change the water filter
	Check whether the inlet pipe is flexed or not	The inlet pipe must be straight
The intensity of cleaning is not strong enough	Check whether the water pressure of cleaning switches to low level or not	Regulate the water pressure according to the Installation & User Manual
	Check whether the inlet filter is blocked or not	Clean the filter mesh or change the water filter
Unusual water flow from the spout	Abnormal operation	Unplug the attaching plug for one minute and then plug it again
The water temperature is not warm enough	Check whether the water temperature switches to low level or not	Regulate the water temperature according to the Installation & User Manual
The cleansing is always leaking	Solenoid valve no longer has any effect	Please contact our Customer Service Team
The cleaning function is not working normally	The human induction system of the toilet seat no longer has any effect	Please contact our Customer Service Team

Dryer

Phenomenon	Fault Diagnoses	Solutions
The dryer blows cold air	Check whether the dryer switches off or not	Regulate the temperature of dryer according to the Installation & User Manual
	Check whether the heating element of dryer is damaged or not	Please contact our Customer Service Team

Heated Seat

Phenomenon	Fault Diagnoses	Solutions
The seat temperature is too low or is not hot	Check whether the temperature of toilet seat is on the OFF position or not	Regulate the temperature of toilet seat according to the Installation & User Manual

Remote Control

Phenomenon	Fault Diagnoses	Solutions
The blue light of water temperature is flickered	Low battery	Please replace a new battery
Remote control is not working	Check whether there is any water on the remote control or not	Wipe off water by dry towel

Toilet Bowl

Phenomenon	Fault Diagnoses	Solutions
The toilet does not flush cleanly	No power supply	Power restoration
	No water from the spout	Please contact our Customer Service Team
	No water but have the sound of flushing	Check whether the pipeline is blended or not, please keep the water supply pipeline open and smooth
	Have water all the time	Please contact our Customer Service Team if there is any unusual with the water inlet valve

Specifications

Product Model		HOROW T03-10
Product Dimensions		26.97 in (L) * 15.55 in (W) * 19.41 in (H)
Product Weight (lb.)		103.62 lb
Rough In Size		10 in
Seat Height		16.57 in
Bowl/Seat Shape		Elongated
Flush Type		Tornado flush
Gallons Per Flush (US gallon)		Single Flush: 1.28
Installation Type		Floor-mount
Rated Voltage		120 V~
Rated Frequency		60 Hz
Rated Power		1050 W (When inlet water temperature is 59 °F)
Power Cord Length		47.24 in
Water Supply Type		DN15 (G1/2)
Water Inlet	Inlet Water Temperature	41 °F ~ 104 °F
	Minimum Pressure	11.6 psi, ensuring a flow of water at least 3.65 GPM
	Maximum pressure	108 psi (static state)
Cleaning	Way for Heating	Instant Heating
	Temperature of Warm Water	Off/about 93.2 °F ~ 102.2 °F (4 levels)
	Safety Devices	Thermostat series, thermal fuse, flow detection device
Dryer	Warm Air Temperature	Off/about 95 °F ~ 131 °F (4 levels)
	Warm Air Speed	Above 4 m/s
	Safety Devices	Bimetal thermostat series, thermal fuse
Heated Seat	Seat Temperature	Off/about 93.2 °F ~ 102.2 °F (4 levels)
	Safety Devices	Thermal fuse, temperature sensor
Remote Control Battery		Two AAA batteries
Blackout Flush Battery		One lithium battery (Separate purchase required)

Warranty

ONE YEAR LIMITED WARRANTY

HOROW products are made with high-quality materials and workmanship to provide customers with products that are built to last. If any defects in material or workmanship are detected during normal use within the first year of purchase, such as the replacement of any product or product part that you consider to be defective, HOROW will provide replacement parts free of charge. We are **not responsible** for all damages that result from **improper installation resulting in unavailability, repair and maintenance**. This warranty applies only to the original purchaser. Proof of purchase and **evidence of damage** will be required in the case of a **claim**.

HOROW recommends the installations to be made by a licensed, professional plumber.

HOROW will not be held responsible for any damage or product failure due to improper installation, misuse, or failure to use a licensed professional. HOROW is not responsible for any removal or installation cost.

This One Year Limited Warranty will be voided if:

The installation recommendations were not followed.

The product has been moved from its initial place of installation.

The product has been modified.

The product has been subjected to improper maintenance, abuse, misuse, excessive use of chemicals, accident or other damages.

HOROW makes no implication that products comply with any or all local building or plumbing codes. It is the consumer's responsibility to determine local code compliance. This warranty extends to the original purchaser and first consumer.

HOROW is not liable for any incidental, consequential or special damages associated with the return, replacement, installation or use of your product. This includes freight costs, labor, travel time, lost profit, home damages and other contingent liabilities and costs (including, without limitation, costs associated with experts, investigations, analyses, attorneys and other professionals and services).

The HOROW warranty is a comprehensive and explicit limit of liability, and all items outside of it are not addressable by or the responsibility of HOROW. Certain states have variances regarding implied warranties and in those situations, we remain fully compliant.

Warranty Registration

Proof of purchase is required to validate this limited warranty. HOROW encourages you to register your product upon purchase to create a record of ownership at www.horow.com. Registration is voluntary and not required to maintain your limited warranty rights.



For any questions or claims, please contact us by phone or email.

Phone: (+1)209-200-8033

Monday to Friday

Email: support@horow.com

When making a claim, please prepare a photo of the evidence of damage so that we can quickly resolve the claim for you.



Warning

Content may contain sharp and other possibly harmful pieces and may cause hazard to children and adults, HOROW is not responsible in any way for personal damage.