

# SOJAG

produits saisonniers • seasonal products



Sojag code: 500-9167825

CUP/UPC code: 772830167825

Costco code: 1399621

QUESTIONS? 1 855 659-4402

## Assembly Manual / Guide d'assemblage / Manual de ensamblaje / 조립 설명서 / Montageanleitung

IMPORTANT, RETAIN FOR FUTURE REFERENCE: READ CAREFULLY

IMPORTANT : CONSERVER POUR RÉFÉRENCE FUTURE ET LIRE ATTENTIVEMENT

IMPORTANTE : CONSERVE PARA REFERENCIA FUTURA. LEA CUIDADOSAMENTE ANTES

Wichtig: für den zukünftigen Gebrauch aufbewahren: sorgfältig lesen.

중요: 주의 깊게 읽고 나중에 참조할 수 있도록 보관하십시오.

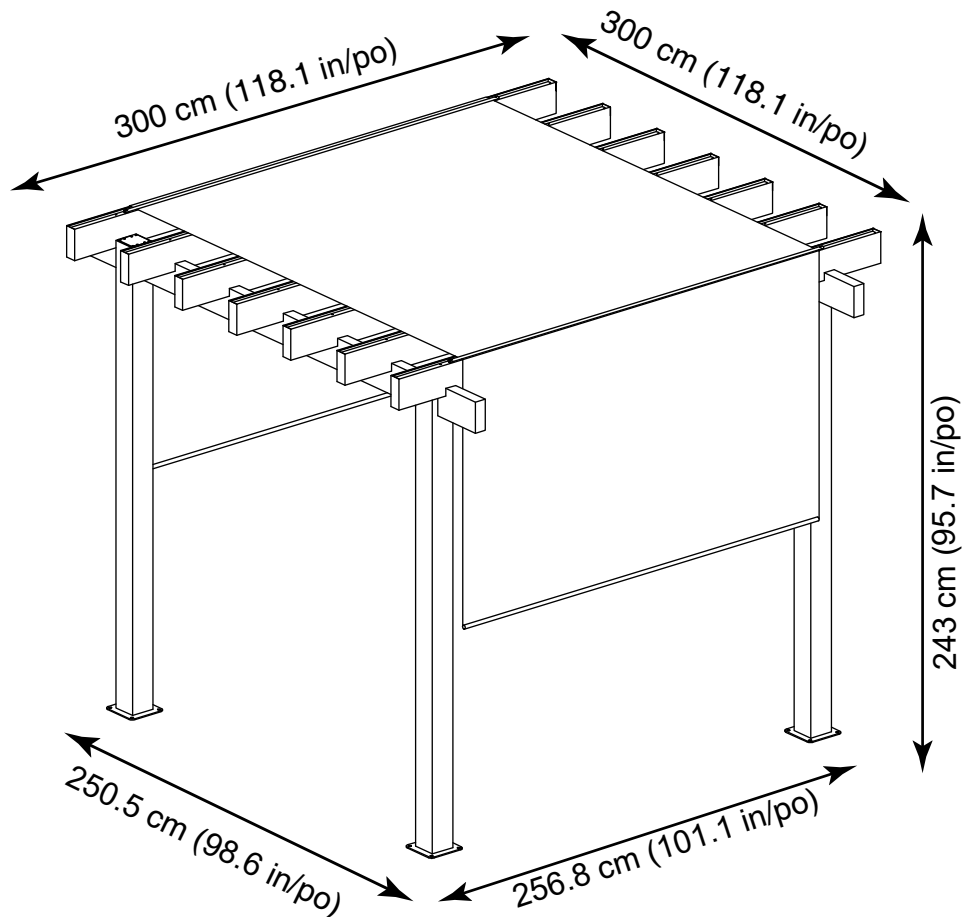

For Outdoor Use only. Not for Commercial Use.

Pour usage extérieur seulement. Pas pour usage commercial.

Solo para uso en exteriores. No para uso comercial.

Nur für den Gebrauch im Freien. Nicht für den kommerziellen Gebrauch geeignet.

이 제품은 옥외용이며 상업용이 아닙니다.

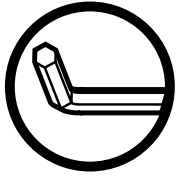

Use the hex keys in the box. / Utilisez les clés hexagonales fournies dans la boîte. / Utilice las llaves hexagonales en la caja. / 상자에 육각 키를 사용 하십시오. / Verwenden Sie die Sechskantschlüssel in der Box.

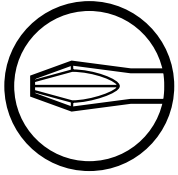

Please use a Phillips screwdriver. / Utilisez un tournevis de type Phillips / Por favor, use un destornillador Phillips. / 십자 드라이버를 사용 하십시오. / Bitte verwenden Sie einen Kreuzschraubenzieher.



You may need to use a drill for this step. / Vous pouvez avoir besoin d'utiliser une perceuse pour cette étape. / Puede que tenga que utilizar un taladro para este paso. / 이 단계에선 드릴을 사용해야 할 수도 있습니다. / Für diesen Schritt können Sie einen Bohrer verwenden.



Wearing protective gloves is recommended. / Le port de gants de protection est recommandé / El uso de guantes de protección se recomienda. / 보호 장갑을 착용 하는 것이 좋습니다. / Das Tragen von Schutzhandschuhen wird empfohlen.



Two or more people are required at this stage. / Deux personnes ou plus sont nécessaires à cette étape. / Dos o más personas se requieren en esta etapa. / 이 단계에서는 두 명 이상이 필요합니다. / Für diesen Bauschritt sind 2 oder mehr Personen erforderlich.



Do not tighten screws all the way for now. / Ne pas visser fermement pour l'instant. / No atornille con firmeza por ahora. / 아직 나사를 단단히 조이지 마십시오. / Bitte die Schrauben zum jetzigen Zeitpunkt noch nicht fest anziehen.

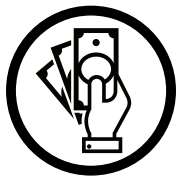

Sold separately. / Vendus séparément. / vendido en las opciones. / 옵션 판매 / Optional erhältlich

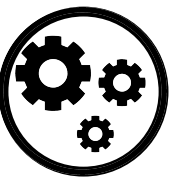

Optional step / Étape optionnelle / Paso opcional / 선택적 단계 / Optionaler Schritt

---

**V** X 224(EXTRA 10 pcs)

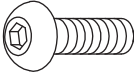

**U** X 28(EXTRA 3 pcs)

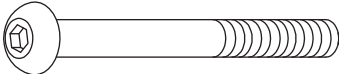

**U1** X 4(EXTRA 1 pcs)

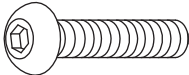

**S** X 16(EXTRA 1 pcs)



**P** X 4(EXTRA 10 pcs)



**Z** X 1

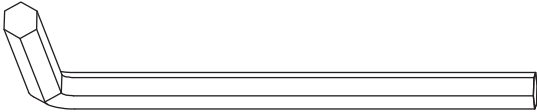

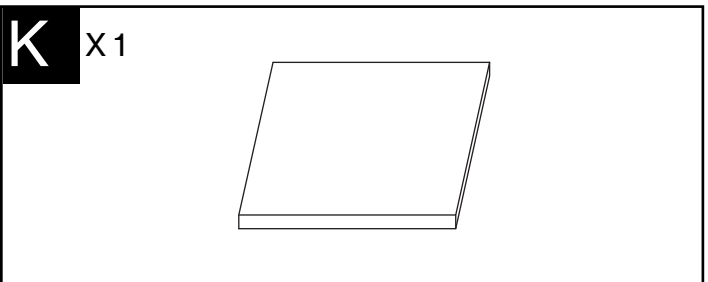
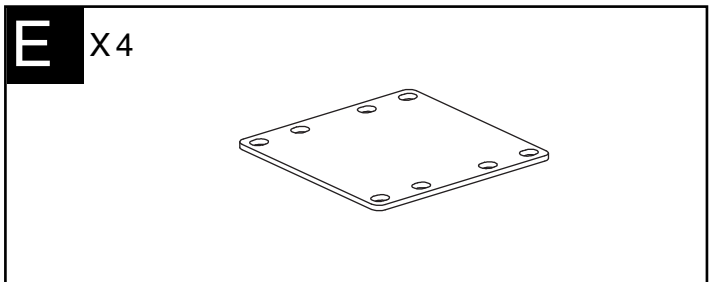
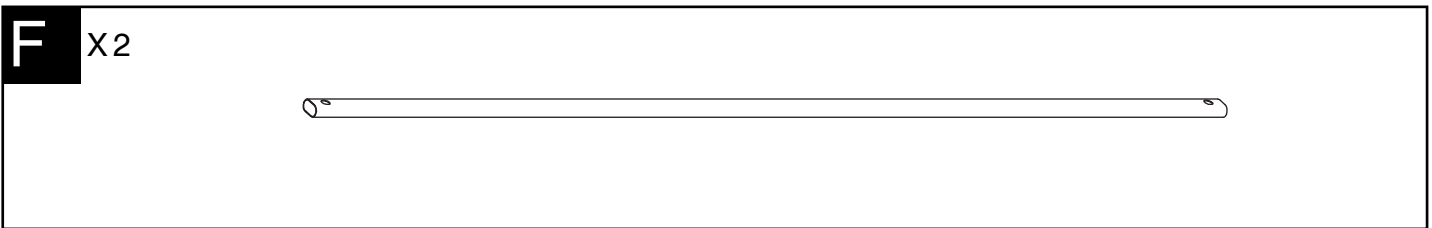
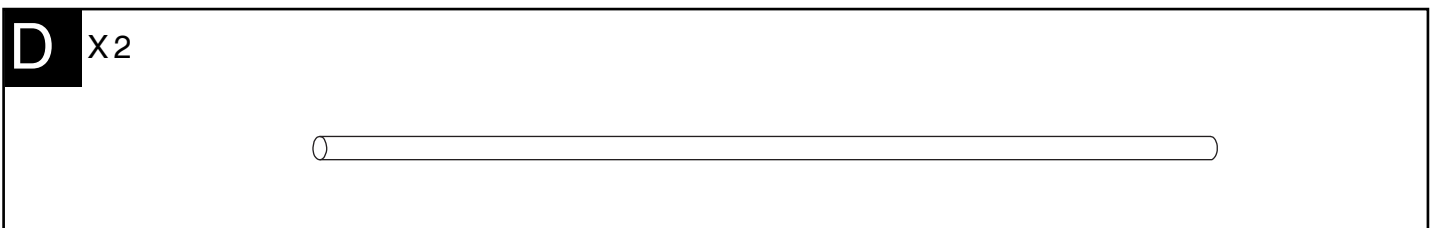
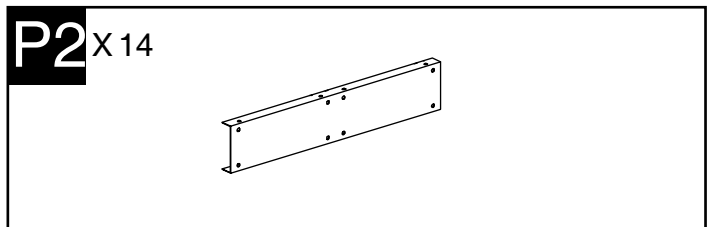
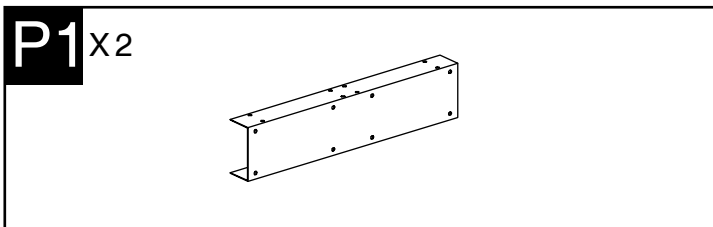
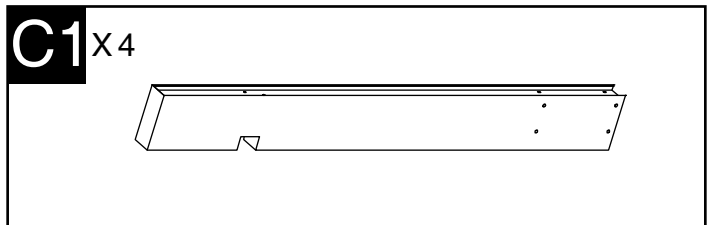
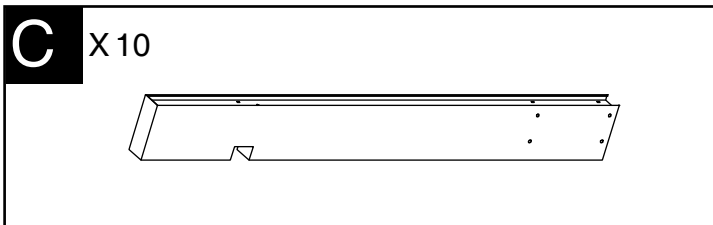
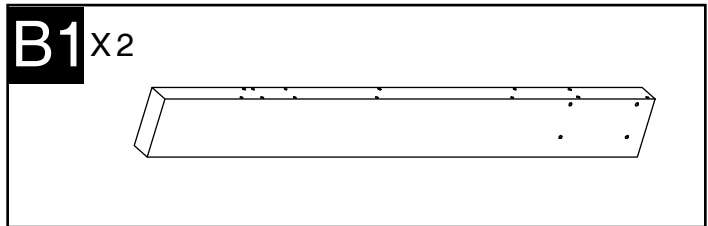
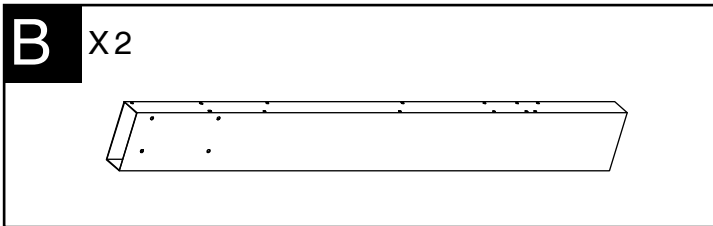
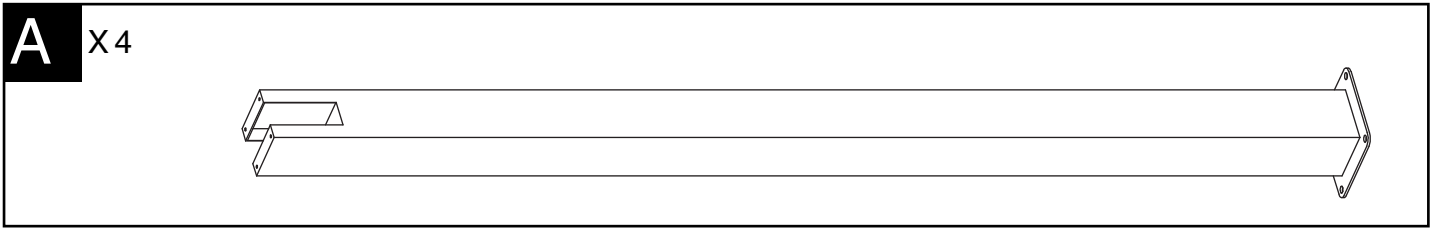

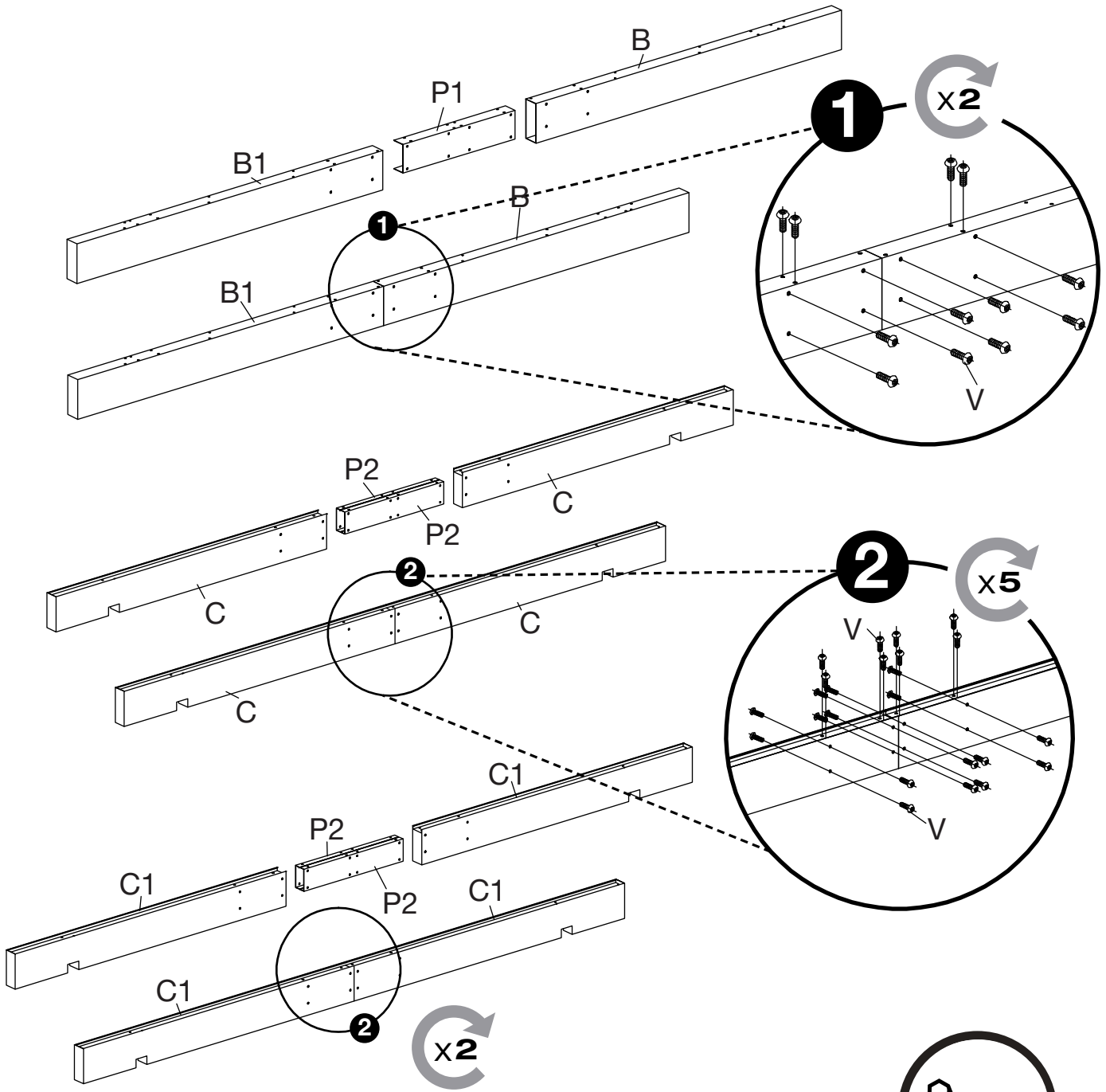

This section contains the parts list for the assembly. It includes illustrations of the following components:

- Bx2
- Cx10
- B1x2
- C1x4
- P1x2
- P2x14
- Vx192

A circular icon in the bottom right corner shows a corner bracket.

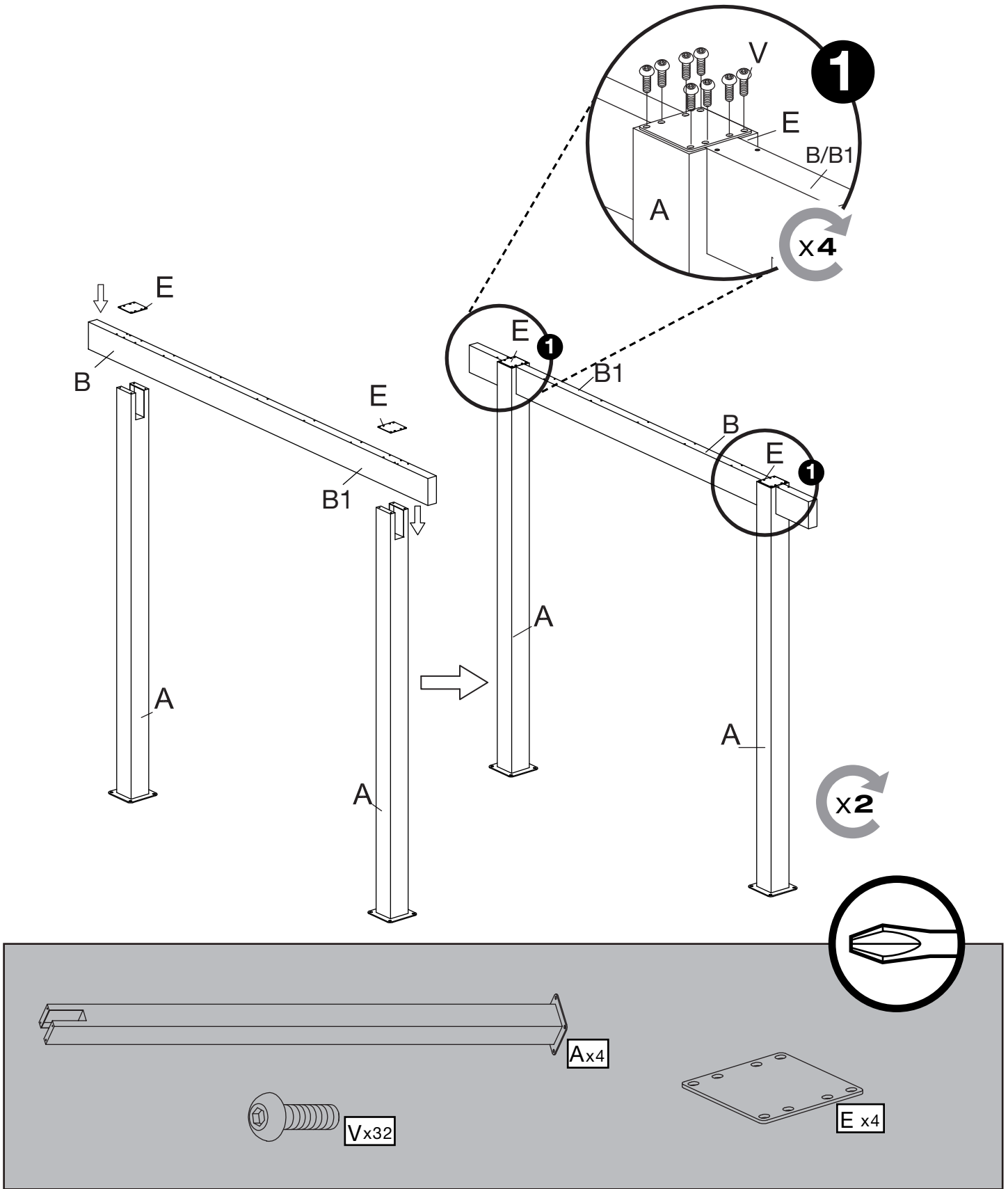



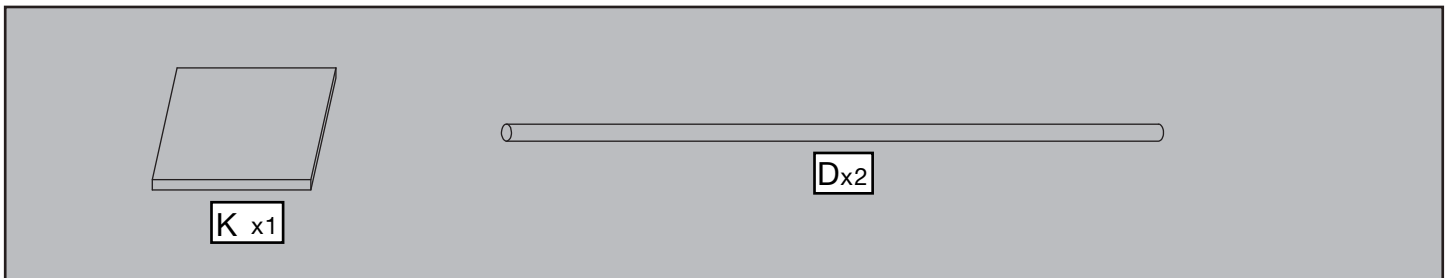
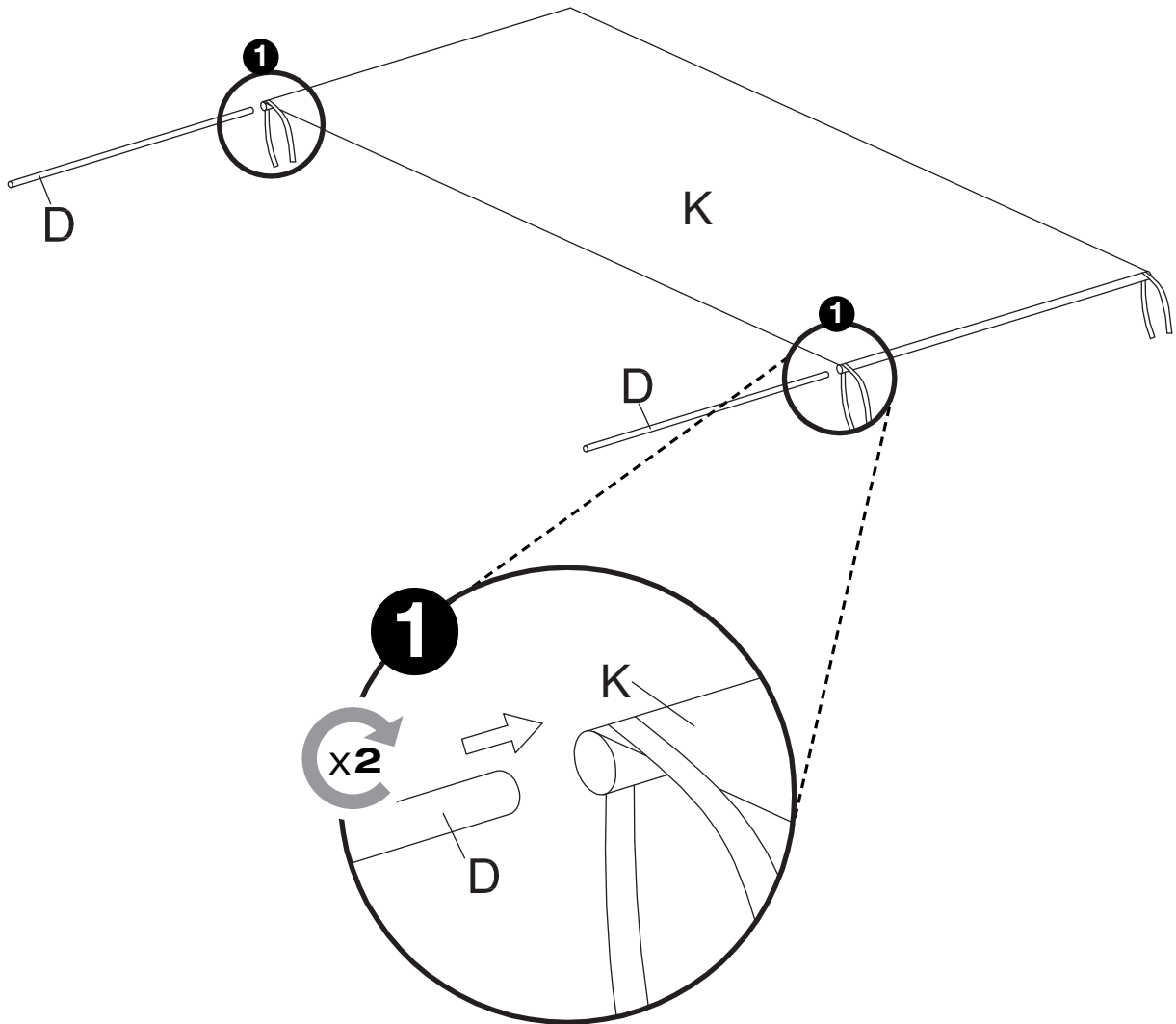





Distributed by:  
Costco Wholesale Corporation  
P.O. Box 34535  
Seattle, WA 98124-1535  
USA  
1-800-774-2678  
www.costco.com

Costco Wholesale Canada Ltd.\*  
415 W. Hunt Club Road  
Ottawa, Ontario  
K2E 1C5, Canada  
1-800-463-3783  
www.costco.ca  
\* faisant affaire au Québec sous  
le nom les Entrepôts Costco

Costco Wholesale UK Ltd /  
Costco Online UK Ltd  
Hartspring Lane  
Watford, Herts  
WD25 8JS  
United Kingdom  
01923 213113  
www.costco.co.uk

Costco Wholesale Spain S.L.U.  
Polígono Empresarial Los Gavilanes  
C/ Agustín de Betancourt, 17  
28906 Getafe (Madrid) España  
NIF: B86509460  
900 111 155  
www.costco.es

Costco Wholesale Japan Ltd.  
3-1-4 Ikegami-Shincho  
Kawasaki-ku, Kawasaki-shi,  
Kanagawa 210-0832 Japan  
0570-032600  
www.costco.co.jp

Costco Wholesale Korea, Ltd.  
40, Iljik-ro  
Gwangmyeong-si  
Gyeonggi-do, 14347, Korea  
1899-9900  
www.costco.co.kr

Importado por:  
Importadora Primex S.A. de C.V.  
Blvd. Magnocentro No. 4  
San Fernando La Herradura  
Huixquilucan, Estado de México  
C.P. 52765  
RFC: IPR-930907-S70  
(55)-5246-5500  
www.costco.com.mx

Costco Wholesale Australia Pty Ltd  
17-21 Parramatta Road  
Lidcombe NSW 2141  
Australia  
www.costco.com.au

Costco Wholesale Iceland ehf.  
Kauptún 3-7, 210 Gardabaer  
Iceland  
www.costco.is

Shanghai Minhang Costco Trading Co., Ltd  
No.235 ZhuJian Road  
Minhang District, Shanghai  
China 201106  
+86-21-6257-7065

Costco Wholesale New Zealand Limited  
67 Maki Street  
Massey, Auckland 0814  
New Zealand

Costco France  
1 avenue de Bréhat  
91140 Villebon-sur-Yvette  
France  
01 80 45 01 10  
www.costco.fr

MADE IN CHINA  
FABRIQUÉ EN CHINE  
HECHO EN CHINA



**SOJAG** ■ I  
produits saisonniers • seasonal products