



Features

- VibrAcoustic calms and soothes with sound vibration technology.
- Six concealed speakers send sound waves through the water to gently massage the body.
- Four original instrumental compositions offer different levels of relaxation.
- Syncs with devices enabled with BLUETOOTH® wireless technology including smartphones, MP3 players, tablets, and laptops located up to 33 feet away.*
- Customize your experience with the high-resolution color touch screen.
- Fully adjustable volume above and below the water.
- Functions as a hydrotherapy bath when full of water and a stereo system when empty.
- Bask® heated surface creates spa-like relaxation with soothing warmth on your back and neck.
- Three heat settings allow you to customize the surface temperature.
- Clearflo slotted overflow for deep soaking.
- Includes 25 feet of wiring and amplifier.
- The BLUETOOTH® word mark and logos are registered trademarks owned by Bluetooth SIG, Inc. and any use of such marks by Kohler Co. is under license. Other trademarks and trade names are those of their respective owners.

Material

- Acrylic

Hydrotherapy

- VibrAcoustic

Installation

- Drop-in or under-mount.
- Requires 110V electrical service.

Additional Hydrotherapy Options

- Soaking Bath - K-1821-0
- Soaking Bath + Bask heated surface - K-1821-W1
- BubbleMassage air bath - K-1822-G
- BubbleMassage air bath + chromatherapy - K-1822-GCR
- BubbleMassage air bath + Bask heated surface + chromatherapy - K-1822-GCW
- VibrAcoustic + BubbleMassage air bath - K-1822-GVB
- VibrAcoustic + BubbleMassage air bath + Bask heated surface + chromatherapy - K-1822-GVBCW
- BubbleMassage air bath + Bask heated surface - K-1822-GW
- Whirlpool + heater - K-1822-H2
- VibrAcoustic - K-1822-VB
- VibrAcoustic + chromatherapy - K-1822-VBC



Codes/Standards









CSA B45.11/IAPMO Z401
ASTM E162
ASTM E662
UL 1795
Greenguard UL 2818 - Gold

KOHLER® Plastic Baths and Receptors Lifetime Limited Warranty

See website for detailed warranty information.

Available Colors/Finishes

Color tiles intended for reference only.

Color	Code	Description
	0	White
	96	Biscuit
	47	Almond
	NY	Dune
	95	Ice™ Grey
	G9	Sandbar
	K4	Cashmere
	58	Thunder™ Grey
	7	Black Black™

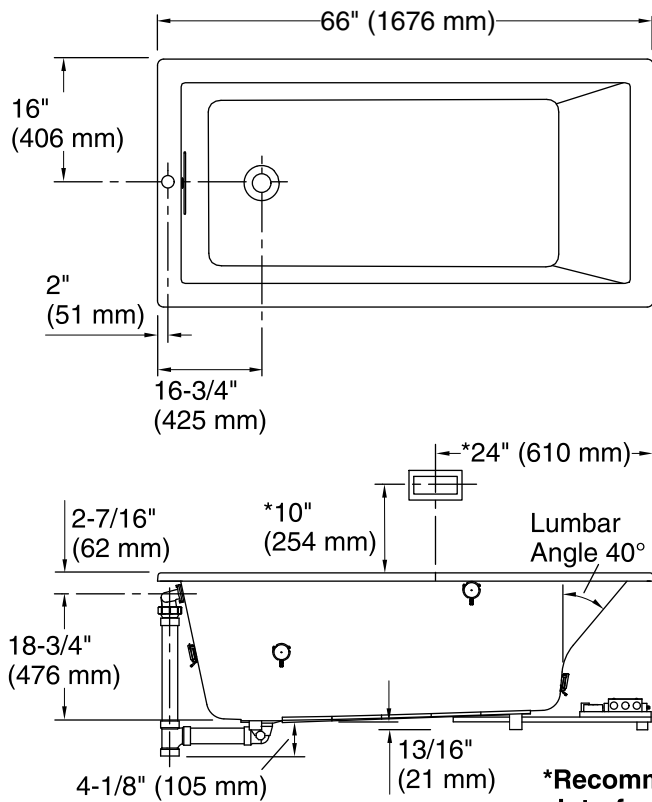

No change in measurement if connected with drain illustrated. (K-7272)

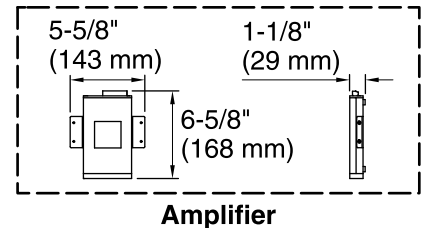
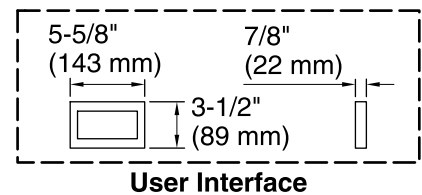
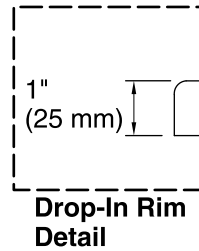

Control Access
 30" (762 mm) W
 x 15" (381 mm) H
 Min

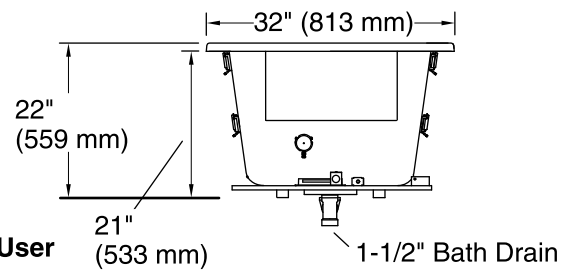

***Recommended User Interface Location**

Required Electrical Service

One circuit required, protected with Class A Ground-Fault Circuit-Interrupter (GFCI) or Residual Current Device (RCD).

Amplifier, Heated Surface: 120 V, 15 A, 50/60 Hz

Technical Information

All product dimensions are nominal.

- Installation: Drop-in, Under-mount
- Drain location: End
- Basin area, bottom: 44-1/2" x 22-5/16" (1130 mm x 567 mm)
- Basin area, top: 59-5/8" x 25-1/2" (1514 mm x 648 mm)
- Weight: 96 lbs (43.5 kg)
- Minimum floor load: 58 lbs/ft² (283.2 kg/m²)
- Water depth: 18" (457 mm)
- Water capacity: 85 gal (321.8 L)
- Cutout: Drop-in, 64-1/2" x 30-1/2" (1638 mm x 775 mm)
- Electrical component rating: Amplifier: 120 V, 50/60 Hz
Heated Surface: 120 V, 0.5 A, 50/60 Hz, 65 W
- Minimum flat for door: 2-1/2" (64 mm)

Notes

Measure your actual product for rough-in details. Install this product according to the installation instructions.

The hot water supply should be 70% of the capacity of the bath or greater. Installations will vary.

Kit is required for under-mount installations (sold separately).

Control amplifier fits 16" (406 mm) center studs. 25' (7.6 m) cables are included.