

Dimension/Specification

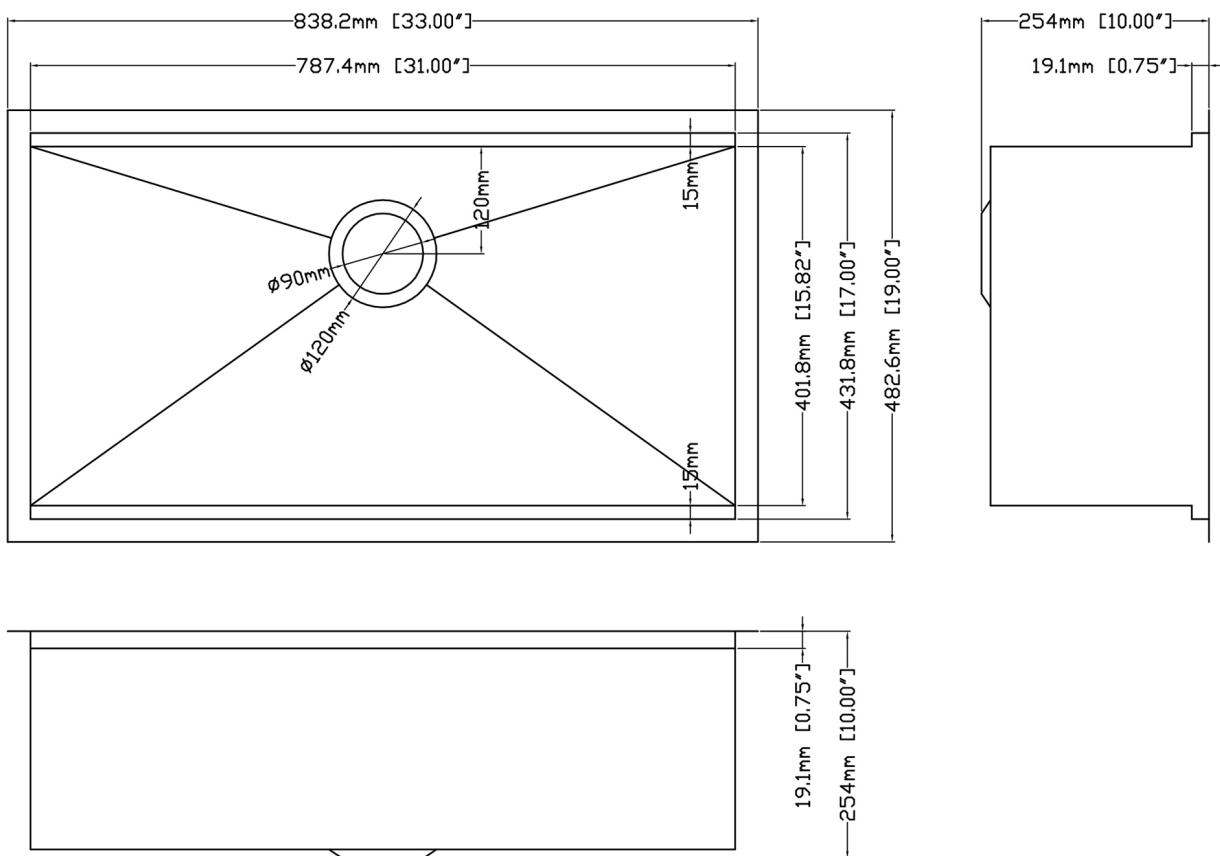

RX-SS28-3319