



### Features

- Comfort Depth® design offers a 19" (483 mm) step-over height.
- Slotted overflow for deep soaking.
- End drain.
- Integral lumbar support and armrests for comfort.

### Hydrotherapy

- 118 BubbleMassage™ airjets.
- Single-speed whirlpool offers eight fully adjustable hydro-massage jets for water flow and direction.
- Pump with air switch for whirlpool.
- Automatic purge cycles remove residual water from air channels after use.
- Lighted keypad control.
- Built-in 1500 W heater.



### Installation

- Drop-in

### Required Accessories

K-7271 Brass Slotted Overflow Bath Drain

or

K-7272 PVC Slotted Overflow Bath Drain

### Recommended Accessories

K-9529 Removable Bath Seat

K-24916 Wireless Music Kit

### ADA

### Codes/Standards

ASME A112.19.7/CSA B45.10

CSA B45.5/IAPMO Z124

ASTM E162

UL 1795

Greenguard UL 2818 - Gold

ADA

ICC/ANSI A117.1







### KOHLER® Plastic Baths and Receptors Lifetime Limited Warranty KOHLER® Hydrotherapy Components Five-Year Limited Warranty

See website for detailed warranty information.

### Available Color/Finishes

*Color tiles intended for reference only.*

#### Color Code Description

	0	White
	96	Biscuit
	47	Almond
	NY	Dune
	95	Ice™ Grey
	G9	Sandbar
	K4	Cashmere

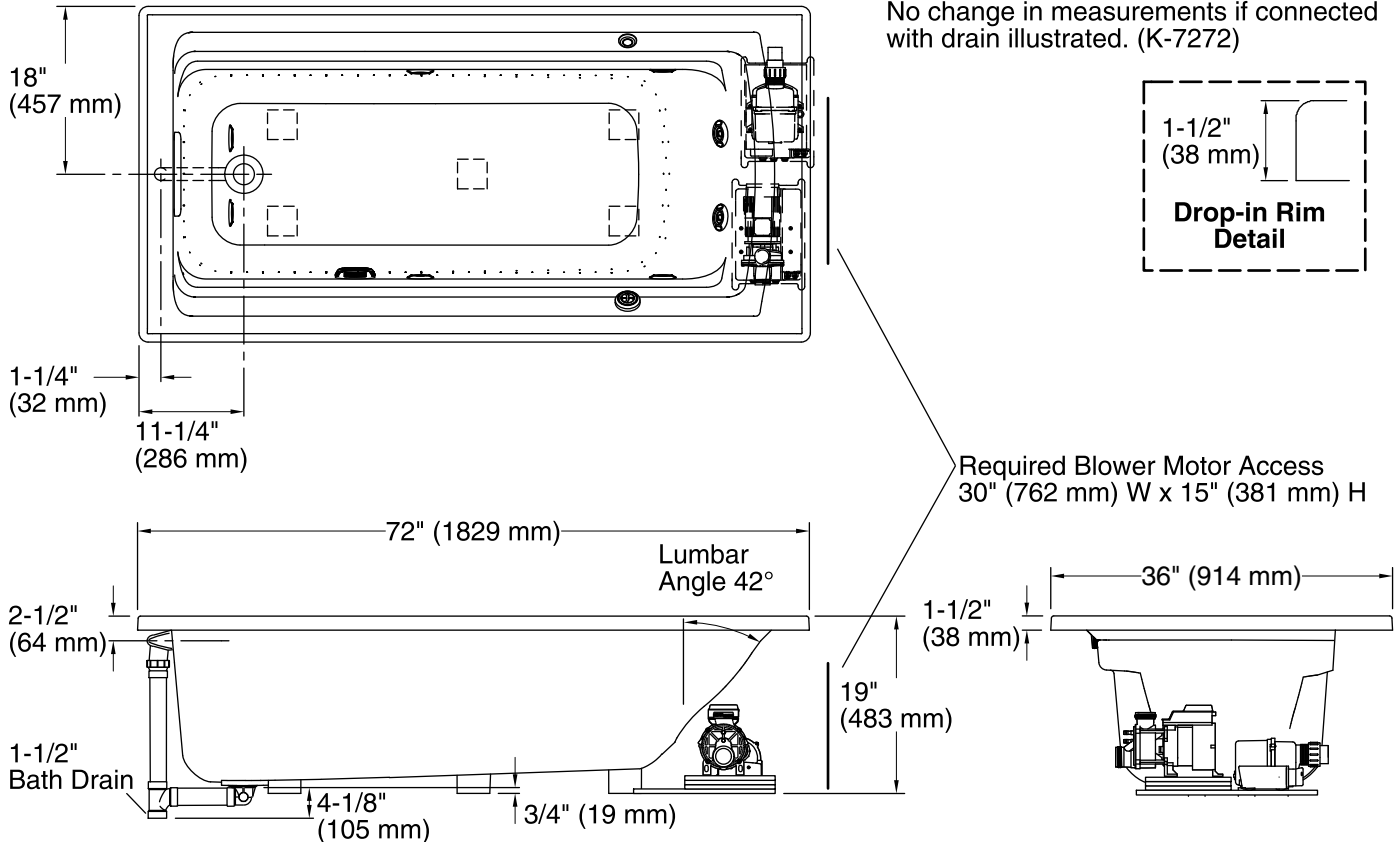

No change in measurements if connected with drain illustrated. (K-7272)

### Required Electrical Service

Three dedicated circuits required, protected with Class A Ground-Fault Circuit-Interrupter (GFCI) or Residual Current Device (RCD).

Pump:	120 V, 15 A, 60 Hz
Blower:	120 V, 15 A, 60 Hz
Heater:	120 V, 15 A, 60 Hz

### Technical Information

All product dimensions are nominal.

Installation:	Drop-in
Drain location:	End
Basin area, bottom:	51-3/8" x 21" (1305 mm x 533 mm)
Basin area, top:	64-1/2" x 30-1/2" (1638 mm x 775 mm)
Weight:	140 lbs (63.5 kg)
Minimum floor load:	43 lbs/ft <sup>2</sup> (209.9 kg/m <sup>2</sup> )
Water depth:	15" (381 mm)
Water capacity:	72 gal (272.5 L)
Cutout:	Drop-in, 70-1/2" x 34-1/2" (1791 mm x 876 mm)

### Notes

Measure your actual product for rough-in details. Install this product according to the installation instructions.

The hot water supply should be 70% of the capacity of the bath or greater. Installations will vary.

This product is designed for drop-in installation only. It is not suited for use in a three-wall alcove with an overhead shower.

Remote blower installation kit is available for relocating the blower. Provide access for servicing the blower.

Do not relocate or alter the PVC tee or coiled flexible tubing connected to the blower. Follow the blower relocation instructions exactly.

ADA compliant when installed to the specific requirements of these regulations.