

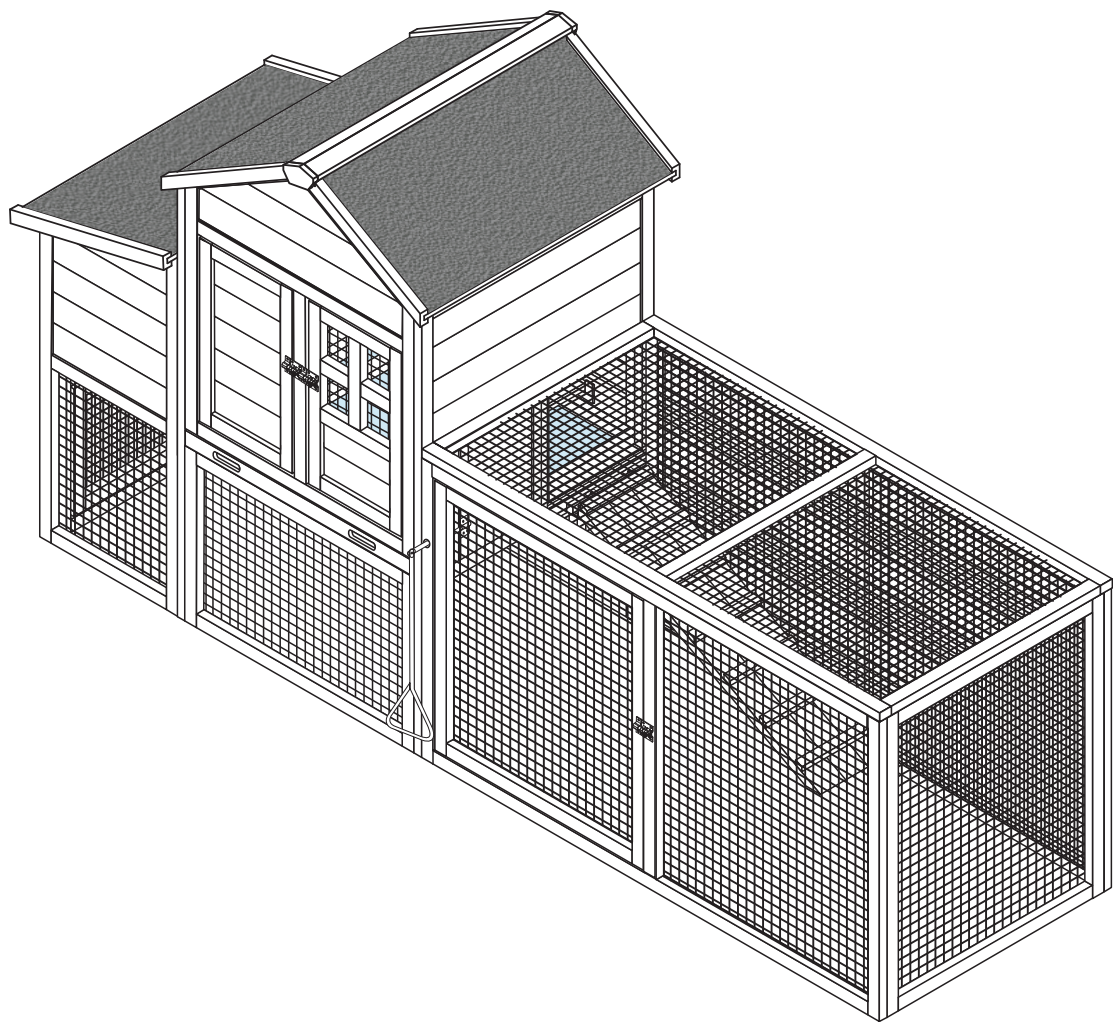

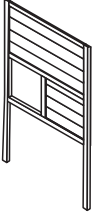

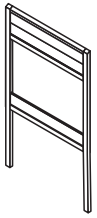

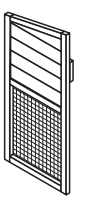

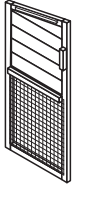
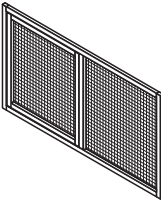
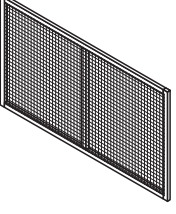
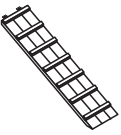

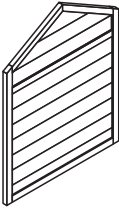
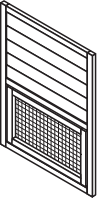
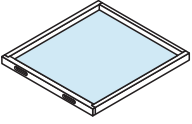
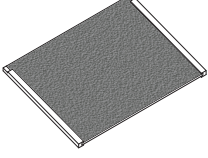
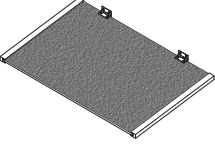
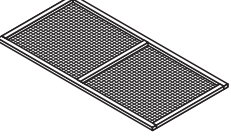
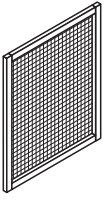
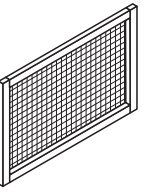
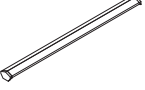
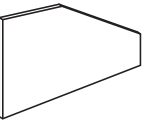
ASSEMBLY INSTRUCTION

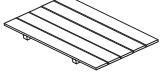

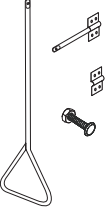
<p>1</p>  <p>1pcs</p>	<p>2</p>  <p>1pcs</p>	<p>3</p>  <p>1pcs</p>	<p>4</p>  <p>1pcs</p>	<p>5</p>  <p>1pcs</p>
<p>6</p>  <p>1pcs</p>	<p>7</p>  <p>1pcs</p>	<p>8</p>  <p>1pcs</p>	<p>9</p>  <p>1pcs</p>	<p>10</p>  <p>1pcs</p>
<p>11</p>  <p>1pcs</p>	<p>12</p>  <p>2pcs</p>	<p>13</p>  <p>1pcs</p>	<p>14</p>  <p>1pcs</p>	<p>15</p>  <p>1pcs</p>
<p>16</p>  <p>2pcs</p>	<p>17</p>  <p>1pcs</p>	<p>18</p>  <p>1pcs</p>	<p>19</p>  <p>2pcs</p>	<p>20</p>  <p>1pcs</p>
<p>21</p>  <p>4pcs</p>	<p>22</p>  <p>1pcs</p>	<p>23</p>  <p>1pcs</p>	<p>24</p>  <p>1pcs</p>	
<p>A M3.5*45</p>  <p>6+1 pcs</p>	<p>B M3.5*40</p>  <p>34+1 pcs</p>	<p>C M3.5*25</p>  <p>2+1 pcs</p>	<p>D M3*20</p>  <p>5+1 pcs</p>	<p>E M3*16</p>  <p>42+1 pcs</p>

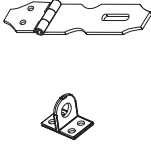
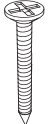
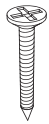
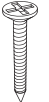
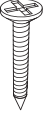
1

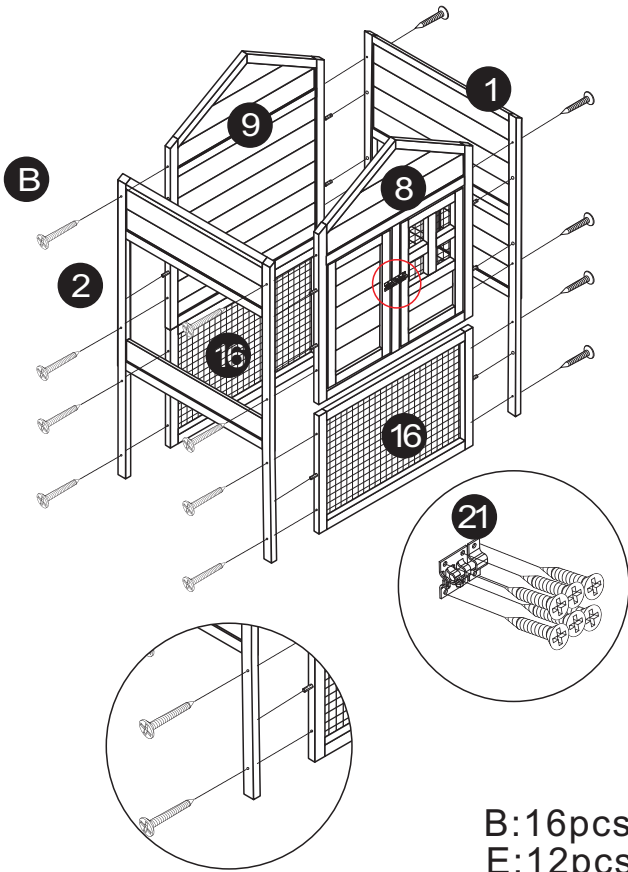

B:16pcs
E:12pcs

2

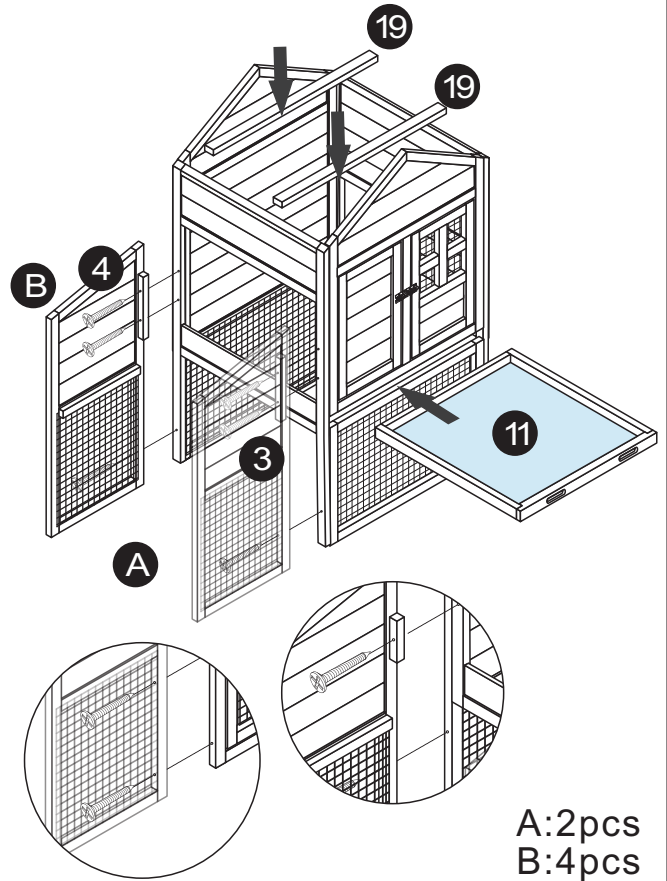

A:2pcs
B:4pcs

3

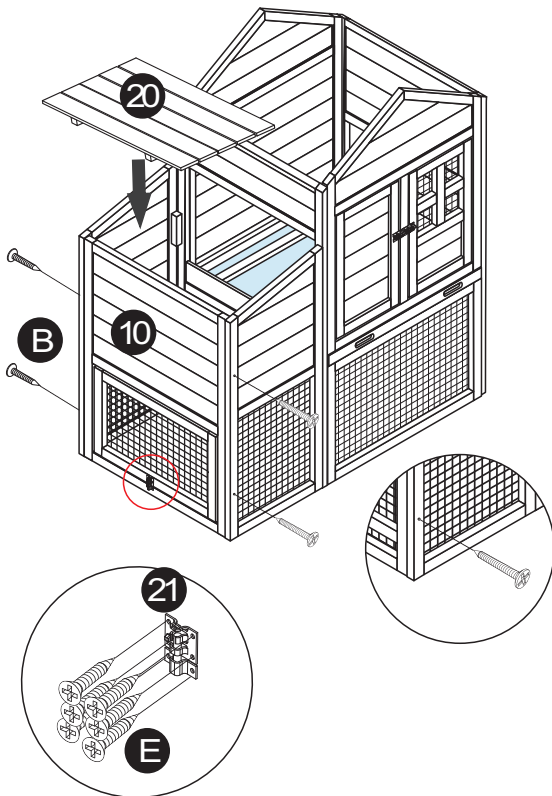

B:4pcs
E:6pcs

4

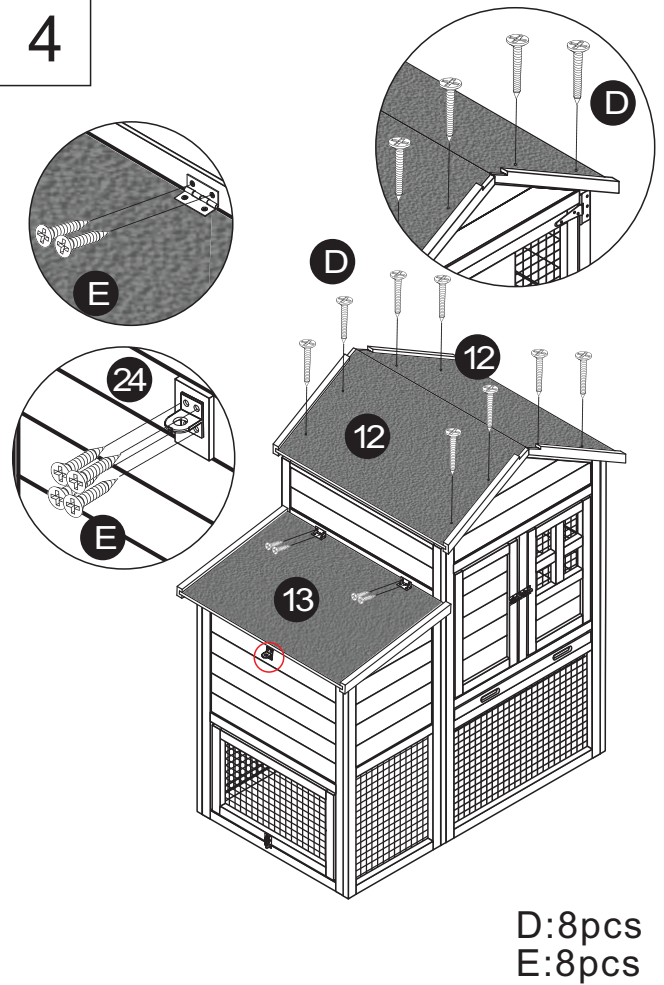

D:8pcs
E:8pcs

5

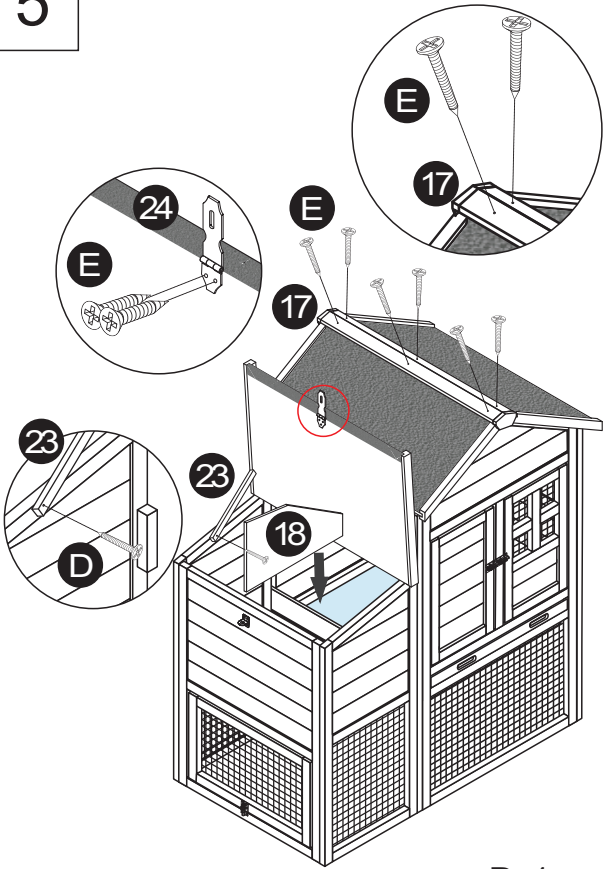

D:1pcs
E:7pcs

6

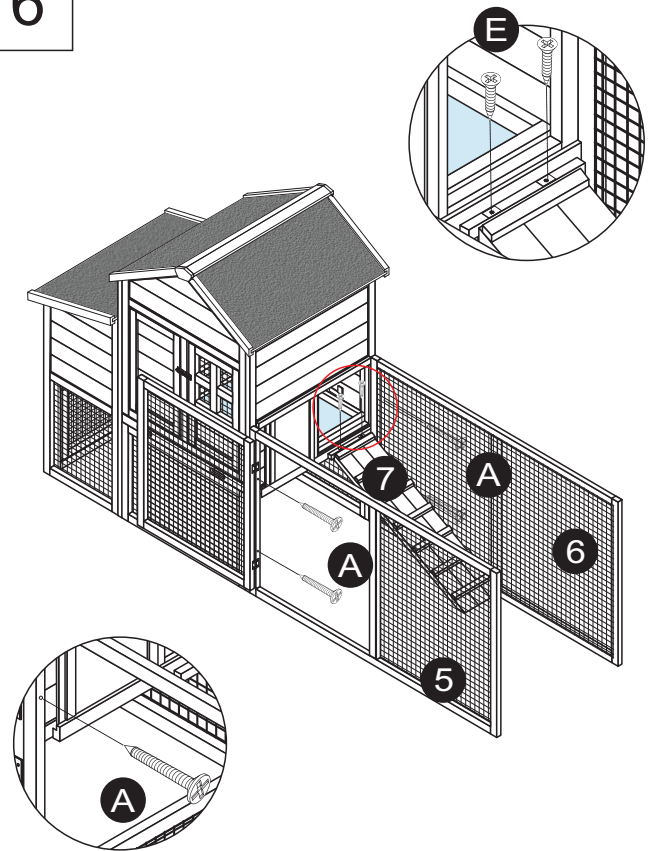

A:4pcs
E:2pcs

7

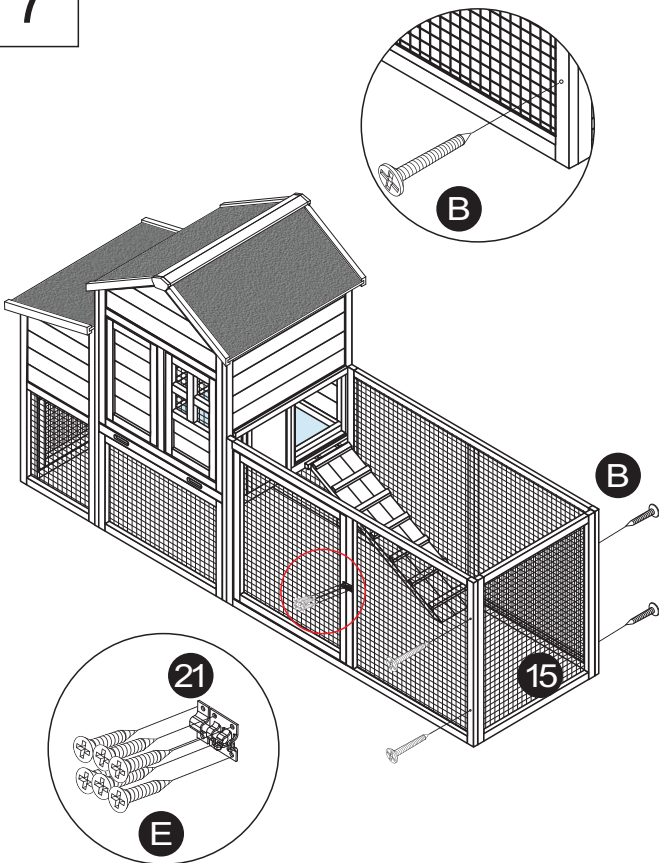

B:4pcs
E:6pcs

8

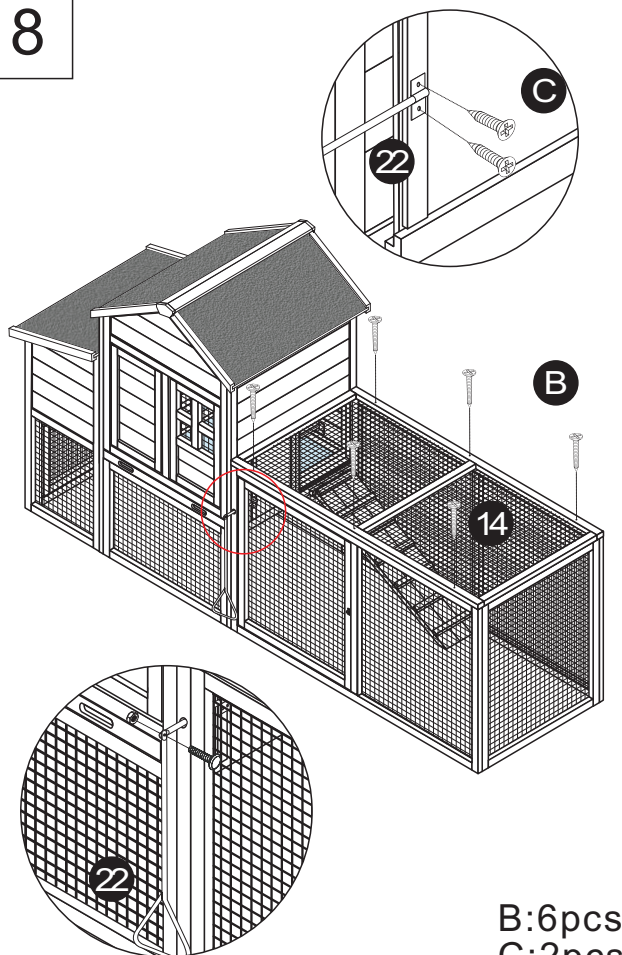

B:6pcs
C:2pcs