

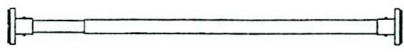



INSTALLATION INSTRUCTIONS INSTRUCTIONS D'INSTALLATION

					
18" - 28"	x 1	x 2	x 2	x 1	-
28" - 48"	x 1	x 2	x 2	x 1	-
48" - 86"	x 1	x 4	x 4	x 1	x 1
66" - 120"	x 1	x 4	x 4	x 1	x 1

◎ SPRING TENSION MOUNT / INSTALLATION RESSORT TENSION

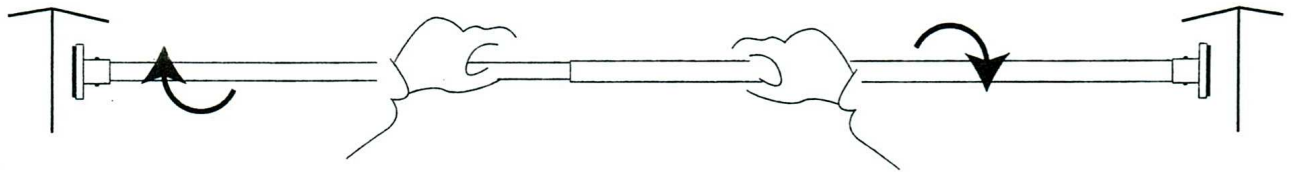

◎ SCREW TENSION MOUNT / INSTALLATION VIS TENSION

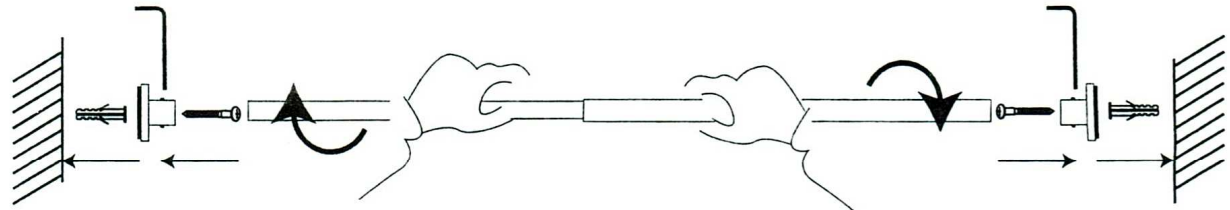



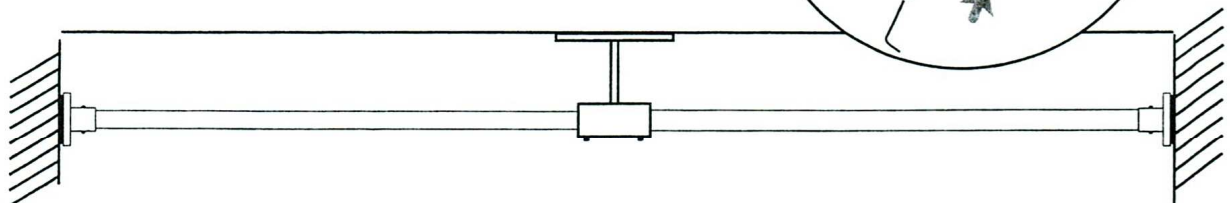
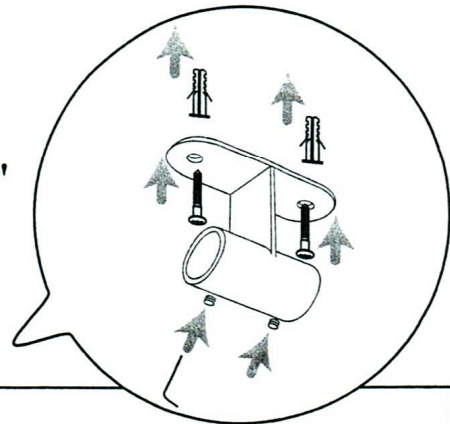

*** Note: For Sizes 48" - 86" & 66" - 120"

P.S: Pour Grandeur 48"-86" & 66"-120"

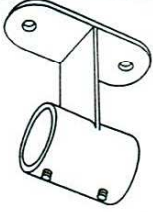

INSTALLATION INSTRUCTIONS

INSTRUCTIONS D'INSTALLATION

				 For 5/8" rod / Pour tringle 16mm
x 1	x 2	x 2	x 1	x 2

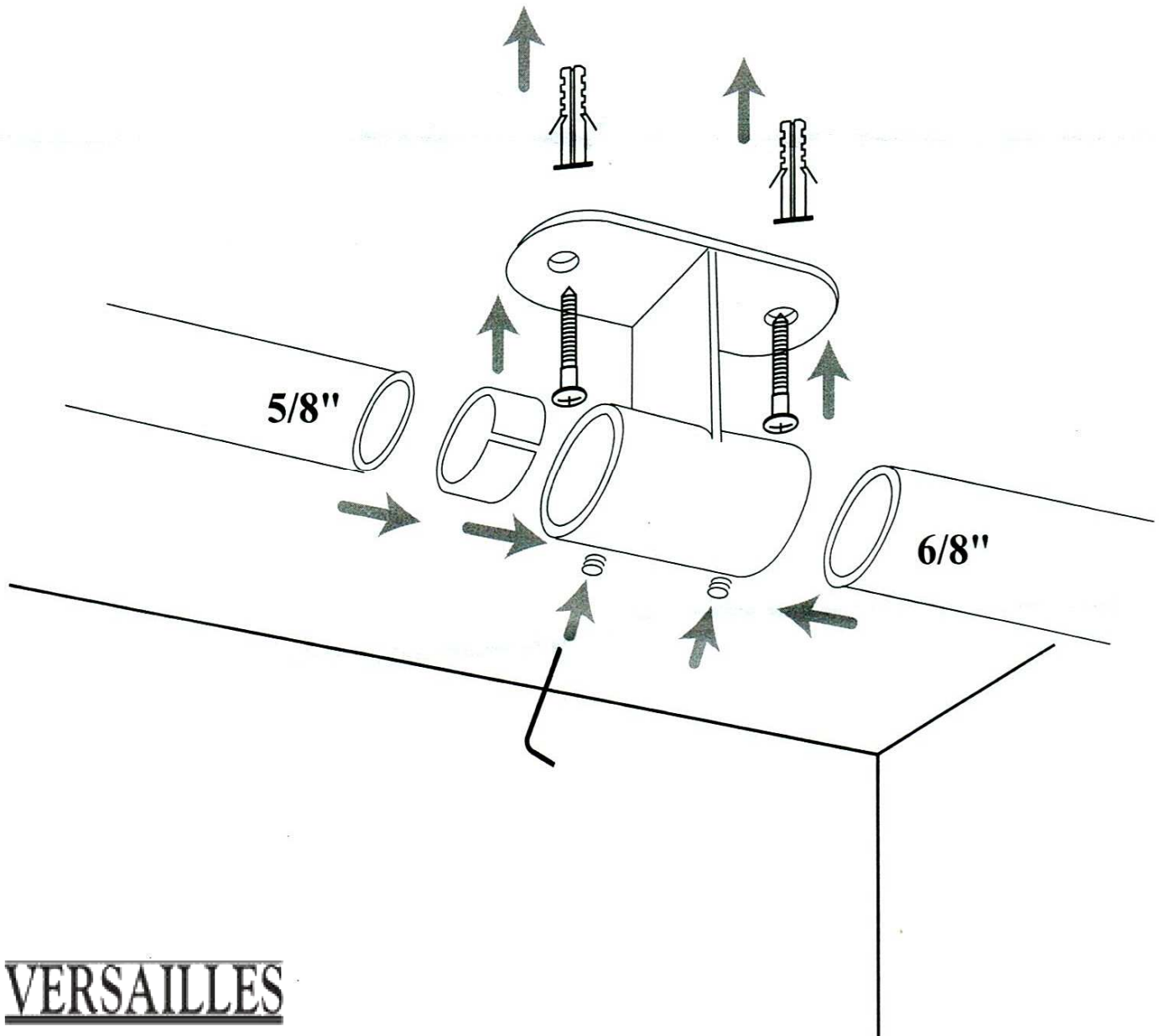

VERSAILLES