



OPERATOR'S MANUAL

MODEL #100515
14-kW HOME STANDBY GENERATOR
WITH aXis CONTROLLER®



REGISTER YOUR PRODUCT ONLINE

at championpowerequipment.com



or visit championpowerequipment.com

SAVE THESE INSTRUCTIONS. This manual contains important safety precautions which should be read and understood before operating the product. Failure to do so could result in serious injury. This manual should remain with the product.

Specifications, descriptions and illustrations in this manual are as accurate as known at the time of publication, but are subject to change without notice.

No part of this publication may be reproduced or used in any form by any means – graphic, electronic or mechanical, including photocopying, recording, taping or information storage and retrieval systems – without the written permission of Champion Power Equipment (CPE).

PROTECT YOUR INVESTMENT!

Register your product to receive

**FREE
10 YEAR
WARRANTY**
Valued at \$699



www.championpowerequipment.com/HSB-offer

PLUS, GET A FREE T-SHIRT!

In exchange for an honest rating and review of your Champion product, we'll give you a FREE T-SHIRT!



REGISTRATION REQUIREMENTS



- Full name
- Address where installed
- Phone number
- Email
- Complete model number* (generator + transfer switch)
- Generator serial number
- Purchase date
- Tshirt size

PROMOTIONAL OFFER VALID FOR ONE HOME STANDBY GENERATOR PURCHASE PER HOUSEHOLD. PLEASE ALLOW UP TO A TOTAL OF 15 BUSINESS DAYS FOR YOUR REGISTRATION TO BE VERIFIED AND FREE ITEMS TO BE MAILED OUT. YOUR 10 YEAR WARRANTY IS ACTIVATED IMMEDIATELY UPON SUBMITTING PRODUCT REGISTRATION THROUGH OUR WEBSITE.

*COMPLETE MODEL NUMBER CAN BE FOUND ON PURCHASE RECEIPT.

Have questions or need assistance?
Do not return this product to the store!

WE ARE HERE TO HELP!

Visit our website:

www.championpowerequipment.com

for more info:

- Product Info & Updates
- Tech Bulletins
- Frequently Asked Questions
- Product Registration

– or –

Call our Customer Care Team Toll-Free at:

1-877-338-0999

This manual must be used with Champion Power Equipment (CPE) manuals:

Installation Manual

Transfer Switch Manual

**We are always working to improve our products. Therefore, the enclosed product may differ slightly from the image on the cover.*

TABLE OF CONTENTS	
Introduction	5
Home Standby Generator	5
Safety	5
Safety Definitions	5
Safety Symbols	6
Important Safety Instructions	8
Installation Hazards	8
Before Starting	8
Operation Hazards	9
Accidental Starting	9
Carbon Monoxide Hazards	9
Electrical Shock Hazards	9
Fire/Explosion Hazards	10
Burn Hazards	10
Entanglement Hazards	10
Battery Hazards	10
Safety Labels and Hang Tags	11
Safety label and Hang Tag locations	13
General Information	14
Component Identification - 14 kW Generator	14
Component Identification – Engine	15
Control Panel	15
aXis Controller®	15
aXis Controller®	16
Wi-Fi Setup Method	19
ATS and HSB Status Using WIFI	22
Programming aXis Controller®	22
Battery Charger	23
Emission Requirements	23
Specifications	24
Fuel System	25
Battery Requirements	25
Battery Charging	25
Model and Serial Number	26
Operation	26
Enclosure and Access	26
Pre-Start Checklist	26
Turning OFF the Generator	26
Maintenance	26
Scheduled Maintenance Chart	27
Spark Plug Specifications	27
Oil Filter Specifications	27
Engine Oil	27
Changing the Engine Oil	28
Inspect and Clean Engine Air Cleaner	28
Spark Plug	29
Battery Maintenance	29
Resetting the Maintenance Hour Meter	29
Corrosion Protection	30
Maintenance After Submersion	31
Storage	31
Return to Service after Storage	31
Troubleshooting HSB	32
Additional Information	34
Identify/Select Standby Circuits	34
Surge Protection	34
Customer Familiarization Summary	34
HSB, ATS Model & Serial Reference ATS Back-up Circuits	35
Maintenance and Service Record	36

INTRODUCTION

Congratulations on your purchase of a Champion Power Equipment (CPE) product. CPE designs, builds, and supports all of our products to strict specifications and guidelines. With proper product knowledge, safe use, and regular maintenance, this product should bring years of satisfying service.

Every effort has been made to ensure the accuracy and completeness of the information in this manual at the time of publication, and we reserve the right to change, alter and/or improve the product and this document at any time without prior notice.

CPE highly values how our products are designed, manufactured, operated, and serviced as well as providing safety to the operator and those around the generator. Therefore, it is **IMPORTANT** to review this product manual and other product materials thoroughly and be fully aware and knowledgeable of the assembly, operation, dangers and maintenance of the product before use. Fully familiarize yourself, and make sure others who plan on operating the product fully familiarize themselves too, with the proper safety and operation procedures before each use. Please always exercise common sense and always err on the side of caution when operating the product to ensure no accident, property damage, or injury occurs. We want you to continue to use and be satisfied with your CPE product for years to come.

When contacting CPE about parts and/or service, you will need to supply the complete model and serial numbers of your product. Transcribe the information found on your product's nameplate label to the table below

CPE TECHNICAL SUPPORT TEAM
1-877-338-0999
MODEL NUMBER
100515
SERIAL NUMBER
DATE OF PURCHASE
PURCHASE LOCATION

HOME STANDBY GENERATOR

This home standby generator is intended exclusively for outdoor installation. This generator will operate using either liquified petroleum gas (LPG) or natural gas (NG).

This generator is designed to supply typical home load such as:

Induction motors – sump pumps, refrigerators, air conditioners, furnaces

Electronic items – televisions, computers

Household lighting

Microwaves

This generator is not intended for use in critical life support applications.

Proper sizing of the generator is required to ensure proper operation of appliances. Some appliances require additional wattage to start and must be considered.

SAFETY

Safety Definitions

The purpose of safety symbols is to attract your attention to possible dangers. The safety symbols, and their explanations, deserve your careful attention and understanding. The safety warnings do not by themselves eliminate any danger. The instructions or warnings they give are not substitutes for proper accident prevention measures.

DANGER

DANGER indicates a hazardous situation which, if not avoided, will result in death or serious injury.

WARNING

WARNING indicates a hazardous situation which, if not avoided, could result in death or serious injury.

CAUTION









CAUTION indicates a hazardous situation which, if not avoided, could result in minor or moderate injury.



NOTICE

NOTICE indicates information considered important, but not hazard-related (e.g., messages relating to property damage).

Safety Symbols

Some of the following symbols may be used on this product. Please study them and learn their meaning. Proper interpretation of these symbols will allow you to more safely operate the product.

SYMBOL	MEANING
	Read Operator's Manual. To reduce the risk of injury, user must read and understand operator's manual before using this product.
	Eye protection. Always wear eye protection with side shields marked to comply with ANSI Z87.1
	Wear personal protective equipment
	Safety alert symbol
	Asphyxiation hazard
	Electrical shock hazard
	Entanglement hazard
	Fire hazard
	Fire/Explosion. Fuel and its vapors are extremely flammable and explosive. Fire or explosion can cause severe burns or death.
	Hot Surface. To reduce the risk of injury or damage, avoid contact with any hot surface.

SYMBOL	MEANING
	Sever hazard (rotating blade)
	Crush hazard (top)

IMPORTANT SAFETY INSTRUCTIONS

⚠ WARNING

Cancer and Reproductive Harm – www.P65Warnings.ca.gov

⚠ DANGER

Generator exhaust contains carbon monoxide, a colorless, odorless, poisonous gas. Breathing carbon monoxide will cause nausea, dizziness, fainting or death. If you start to feel dizzy or weak, get to fresh air immediately.

GENERATOR MUST BE INSTALLED AND OPERATED OUTDOORS ONLY.

Carbon monoxide (CO) poisoning symptoms include but are not limited to the following:

- Lightheadedness, dizziness, blurred vision
- Physical fatigue, weakness in joints and muscles
- Mental fatigue, sleepiness, inability to concentrate or speak clearly,
- Stomachache, vomiting, nausea

In the event of carbon monoxide (CO) poisoning:

- Seek fresh air immediately
- DO NOT sit, lie down or fall asleep.
- Alert others to the possibility of carbon monoxide (CO) poisoning.
- If the affected person does not improve within minutes of breathing fresh air, call 911 immediately for medical assistance.

⚠ WARNING

Do not use generator for medical and life support uses.

In case of emergency, call 911 immediately.

NEVER use this product to power life support devices or life support appliances.

NEVER use this product to power medical devices or medical appliances.

Inform your electricity provider immediately if you or anyone in your household depends on electrical equipment to live.

Inform your electrical provider immediately if a loss of power would cause you or anyone in your household to experience a medical emergency.

Installation Hazards

⚠ WARNING

Have only a qualified electrician or installation technician who is familiar with applicable codes, standards and regulations install and service the generator.

ALWAYS comply with local, state and national electrical and building codes when installing the generator. NEVER alter the recommended installation in a way that would render the unit non compliant with these codes.

ALWAYS comply with regulations that Occupational Safety and Health Administration (OSHA) has established.

ENSURE the generator is installed following the manufacturer's instructions.

Before Starting

⚠ CAUTION

Before operation, read and understand the features and controls of the generator, including the safety information of this manual.

The owner/operator is responsible for safe operation and maintenance of the generator. Be sure all potential users of the generator also understand these instructions. If any portion of this manual is not understood, contact your dealer for assistance before operating the generator.

The operator is responsible for performing all safety checks, making sure all maintenance is properly performed and making sure the generator is periodically checked by the dealer.

Inspect the generator regularly. Contact your dealer if repairs are needed.

NEVER climb or step on any part or components of the generator. Doing so may result in injury and cause leaking fuel and exhaust.

Operation Hazards

⚠ WARNING

ALWAYS operate the generator following the manufacturer's instructions. Operating the generator improperly or neglecting maintenance can result in serious injury or possible death.

DO NOT allow children or unqualified persons to operate or service the generator.

NEVER operate the generator with the covers open. Operate the generator only with the covers closed and secured in place. NEVER leave the covers unlocked.

Remain alert at all times when working on the generator. NEVER work on the generator when physically or mentally fatigued.

NEVER operate the generator while under the influence of alcohol or drugs.

Accidental Starting

⚠ WARNING

ALWAYS prevent the generator from starting while the covers are open. The generator may crank and start at any time without notice. Follow these steps in order:

1. Pull fuse from aXis Controller® panel and secure with tape to the panel.
2. Disconnect the NEGATIVE, NEG or (-) battery cable first, and then remove the POSITIVE, POS or (+) battery cable.

To return the generator to service, follow these steps in order:

1. Connect the POSITIVE, POS or (+) battery cable first, and then connect the NEGATIVE, NEG or (-) battery cable.
2. Remove taped fuse from the panel and reinstall into the aXis Controller®.

Carbon Monoxide Hazards

⚠ DANGER

- Generator must be installed and operated outdoors only.
- NEVER allow exhaust fumes to enter a confined area through windows, doors, air intake vents or other openings of the building
- ALWAYS avoid breathing exhaust fumes when near an operating generator.
- NEVER alter the generator or modify the exhaust system thereby creating noncompliance with Federal and State emissions regulations, local applicable codes, standards and laws.
- NEVER allow blockage of the engine's air intake cooling ventilation system. Doing so can seriously affect performance and safe operation of the generator.
- Install a battery-operated carbon monoxide (CO) detector on each level of any building adjacent to the generator location following the manufacturer's CO detector installation instructions.

🗨 NOTICE

In many States it is required by law to have a Carbon Monoxide (CO) detector on each level of any building in operating condition.

Carbon Monoxide (CO) is a colorless, odorless, poisonous gas. Breathing carbon monoxide will cause nausea, dizziness, fainting or death.

A Carbon Monoxide (CO) detector is a device that detects elevated hazardous levels of CO and will alert the occupants by flashing a visual light indicator and an audible alarm.

Electrical Shock Hazards

⚠ WARNING

Use extreme caution when near the generator while it is operating. The generator produces dangerous voltage.

⚠ WARNING

- Avoid contact with bare wires, terminals and connections while the generator is operating.
- ALWAYS stand on an insulated dry surface to reduce shock hazard if work must be done on an operating generator.
- NEVER wear jewelry that can conduct electricity when working on the generator.
- NEVER handle any kind of electrical device while hands or feet are wet, while standing in water or while barefoot.
- Proper earth grounding of the frame and external electrical conductive components is required by the National Electrical Code (NEC). State and local codes for proper grounding may also apply.
- Avoid direct contact with an electric shock victim. Immediately shut down the source of electrical power. If this is not possible, attempt to free the victim from the live conductor using a nonconducting item such as a dry board or rope. If the victim is unconscious, apply first aid and call 911 immediately.

Fire/Explosion Hazards**⚠ WARNING**

Natural Gas (NG) and Liquefied Petroleum Gas (LPG) are extremely explosive.

- NEVER allow any flames or smoke near the fuel system.
- Wipe up any oil spills immediately.
- NEVER allow any combustible materials to be near the generator or to be left in the generator compartment.
- ALWAYS keep the surrounding area near the generator clean and free of debris.
- Be sure to properly purge the fuel lines and leak-test according to applicable codes before placing the generator in service.
- Be sure to regularly inspect the fuel system for leaks. NEVER operate the generator if a fuel leak is present.
- Install a fire extinguisher near the generator. Keep it properly charged and be familiar with its use. An ABC rated National Fire Protection extinguisher is appropriate for use on standby electric systems. Contact your local fire department with any questions concerning the fire extinguisher.

Burn Hazards**⚠ WARNING**

DO NOT touch hot surfaces.

- ALWAYS avoid contact with hot exhaust components and gases. Running engines produce heat. Severe burns can occur on contact.
- ALWAYS allow hot surfaces to cool to the touch.

Entanglement Hazards**⚠ WARNING**

Use extreme caution when near rotating parts. Rotating parts can entangle hands, feet, hair, clothing and/or accessories. Traumatic amputation or severe laceration can result.

- Keep hands and feet away from rotating parts.
- Tie up long hair and remove jewelry.
- Operate equipment with guards in place.
- DO NOT wear loose-fitting clothing, dangling drawstrings or items that could become caught.

Battery Hazards**⚠ WARNING**

Always read and comply with the battery manufacturer's recommendations for procedures concerning proper battery use and maintenance.



Batteries contain sulfuric acid and generate explosive mixtures of hydrogen and oxygen gases. Keep any device that may cause sparks or flames away from the battery to prevent explosion.



Always wear protective glasses or goggles and protective clothing when working with batteries. You must follow the battery manufacturer's instructions on safety, maintenance and installation procedures.





SAFETY LABELS AND HANG TAGS

⚠ WARNING

DO NOT operate the generator if there are missing or badly worn safety labels. Safety labels must be legible to alert personnel of safety hazards.

- Replace any illegible or missing label immediately. Missing safety labels must be replaced in their original position before the generator is operated.

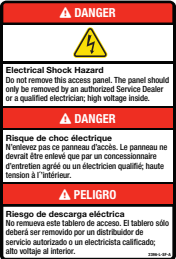
Labels

	LABEL	DESCRIPTION	PART NO.
A		Poison, Burn and Fire Warning	2510-L-SF
B		Burn Warning	2483-L-SF
C		Electrocution Warning	2396-L-SF
D		Burn Warning	2473-L-SF
E		Electrocution Warning	2474-L-SF

LABEL			DESCRIPTION	PART NO.
F			Explosion Warning, Read OM, Starting Warning	2470-L-SF

Hang Tags

HANG TAG		DESCRIPTION	PART NO.
1		Alternate Power Source	1681-T-OP

Safety label and Hang Tag locations

The safety labels have specific placement and must be replaced if they are unreadable, damaged or missing.

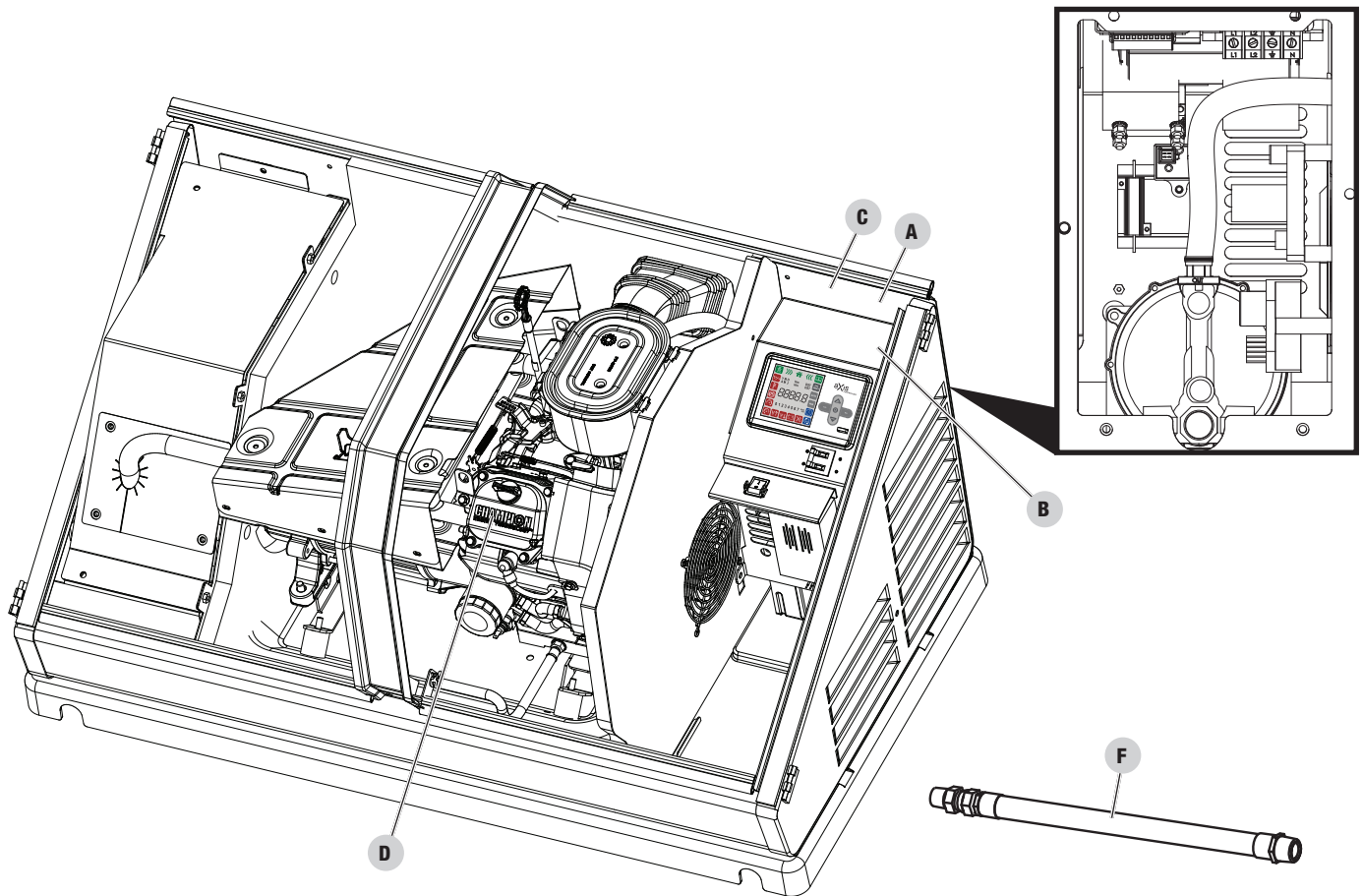

- A. Serial number location
- B. Nameplate
- C. NFPA 37 Compliance
- D. Oil hang tag

- E. Alternate power source (not shown – in the OM bag)
- F. Flexible Fuel Line hang tag

GENERAL INFORMATION

Component Identification - 14 kW Generator

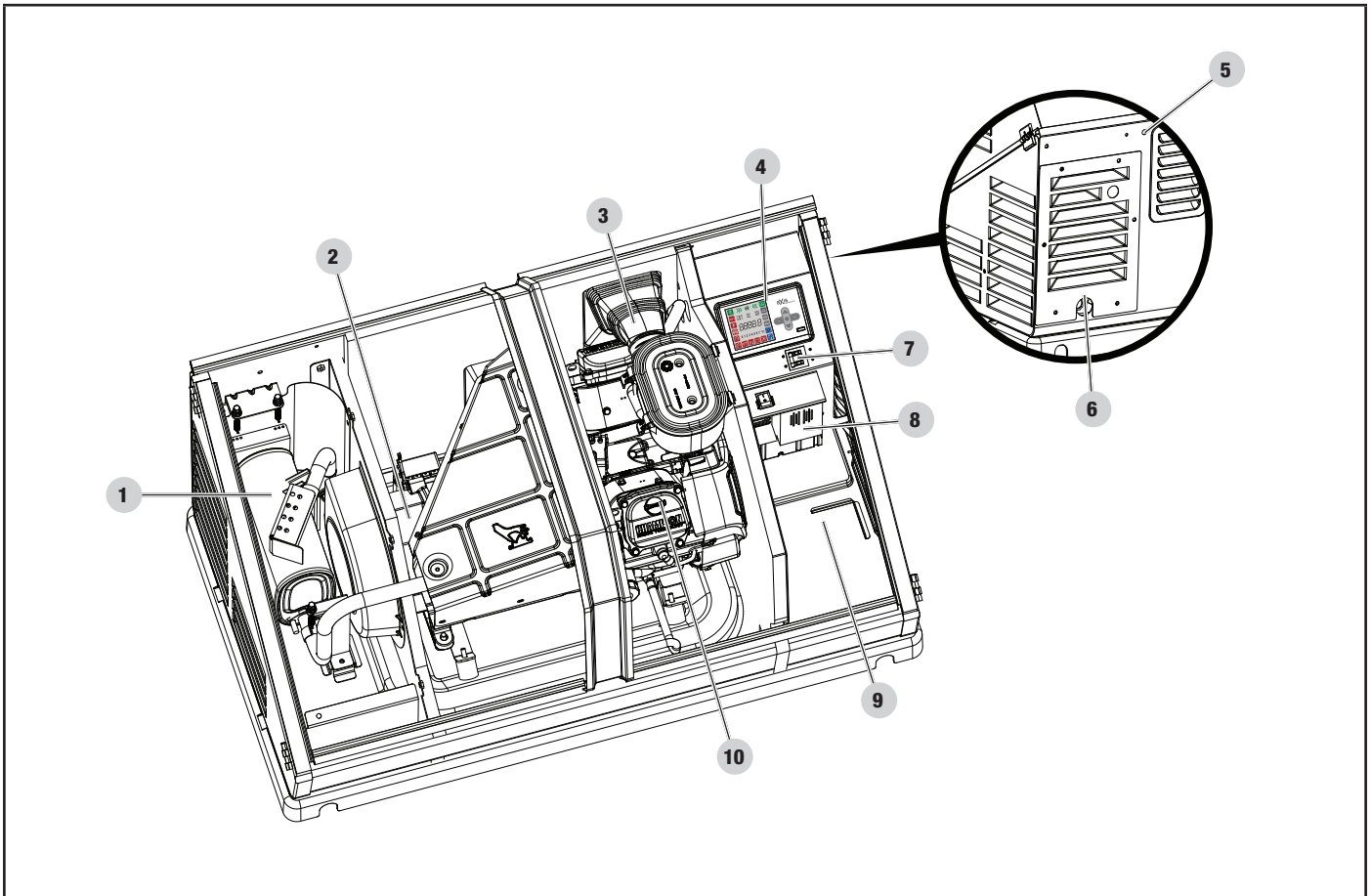

1. Exhaust System
2. Alternator
3. Air Inlet
4. aXis Controller®
5. Main Circuit Breaker
6. Exterior Fault Code Indicator Light
7. Fuel Regulator/Wire Connections (behind panel)
8. Generator ON/OFF or Emergency Shut Off Switch
9. Batteries (not included)
10. Engine

Component Identification – Engine

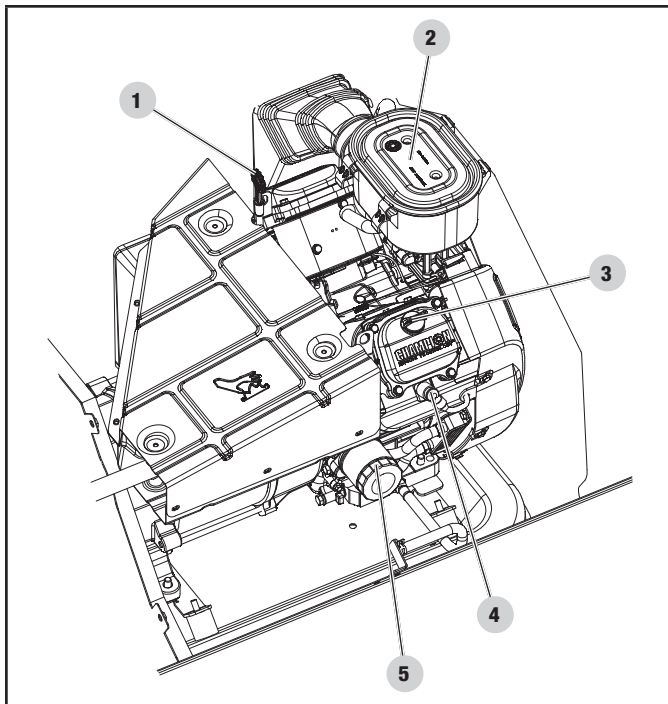

- 1. Engine Oil Dipstick
- 2. Air Cleaner
- 3. Oil Cap
- 4. Spark Plug (second on opposite side)
- 5. Oil Filter

Control Panel

MAIN CIRCUIT BREAKER

The 65-amp main circuit breaker protects the generator from circuit overload. The main circuit breaker controls total output of the generator. The main circuit breaker must be in the ON position for the aXis ATS to communicate with this standby generator.

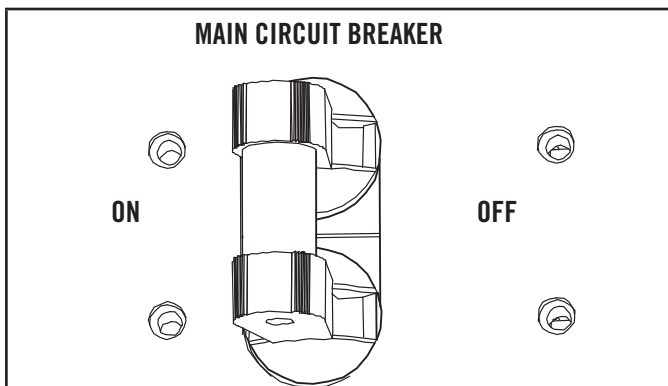

GENERATOR ON/OFF SWITCH

This generator has an ON/OFF switch that when turned off, will shut down the HSB (if running) and deactivate the aXis controller preventing future starts. This switch should be used in instances where the HSB needs to stay off regardless of utility power presence. When the switch is in the OFF position, the HSB will not exercise or start for any reason.

NOTE: *If maintenance or service work is going to be performed on the generator or the home's electrical system, if it is required accidental startup is further safeguarded by pulling IF the fuse from the aXis controller panel and disconnecting the batteries.*

When the switch is in the ON position, the aXis controller will be energized and the HSB will be controlled by the programming of the aXis controller. The switch needs to be in the ON position in order for the HSB to be in AUTO mode.

NOTE: *This switch needs to be in the ON position to place the aXis Controller in the AUTO mode in order to exercise the HSB.*

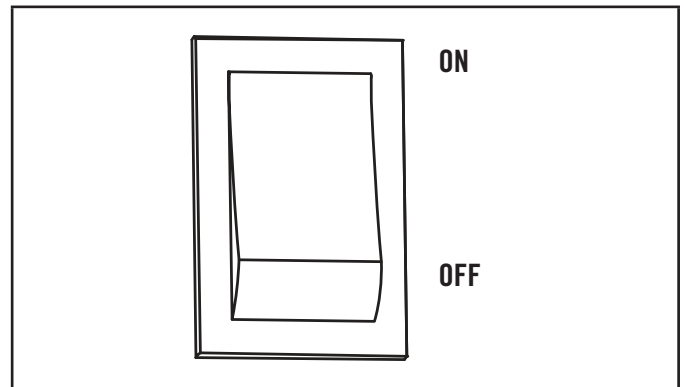

aXis Controller®

The aXis Controller is equipped to provide monitoring and protection for the HSB.

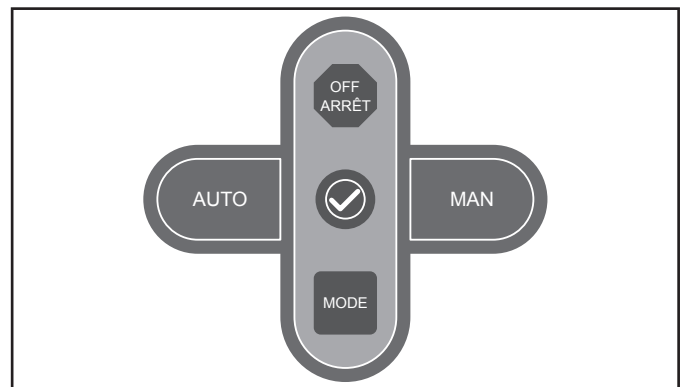

MAN

This button allows verification that the HSB power delivery circuit is functional. The engine will start in manual mode. Safety procedures should be followed. Prior to placing the aXis Controller in the “MAN” mode, the UTILITY, ATS active and LOAD Icon will be lit.

AUTO

This button allows automatic delivery of power from the HSB when there is a utility power outage. With the controller in the AUTO position and the HSB not running (standby mode), the UTILITY, ATS active and LOAD icon will be lit (view left to right), this indicates the household is using Utility power. AUTO position is the standby ready position. The aXis Controller must be in the AUTO mode in order to exercise.

OFF

This button closes and shuts down the engine signals. It prevents the automatic operation of the generator. OFF is required when all maintenance or service are being performed on or around the unit.

MODE

This button allows user to cycle through screens of the aXis Controller.

Cycles through available menus in run mode:

- DCV (first screen) – indicates current battery voltage
- HZ – indicates alternator frequency
- ACV – indicates alternator voltage
- HR – indicates total run hours on Home Standby



- Check button is used when programming the aXis Controller.

aXis Controller®

aXis CONTROLLER STATUS ICONS

The status icons are located at the top of the aXis Controller.

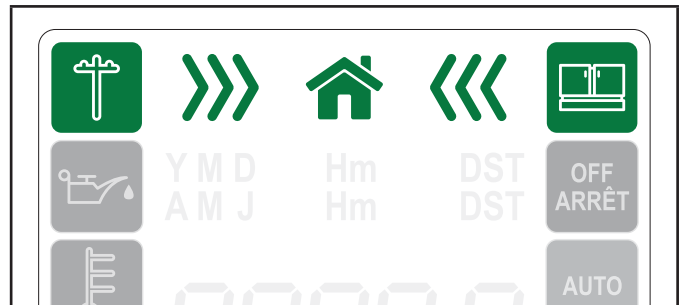

Utility Pole



The utility pole icon will indicate power source when the utility is the source of power.

Transfer Power Direction

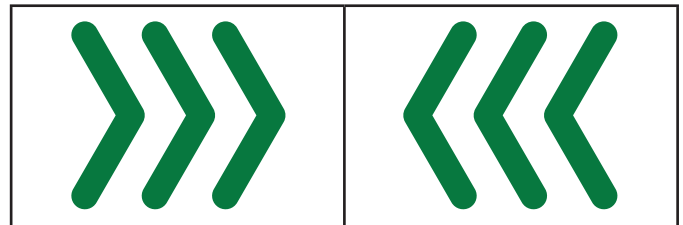

Shows the direction of power

House



Icon for house receiving power

HSB



The HSB icon will indicate power when the generator is the source of power

aXis CONTROLLER INFORMATION ICONS

The information icons are located at the bottom right side of aXis Controller icon touch pad.

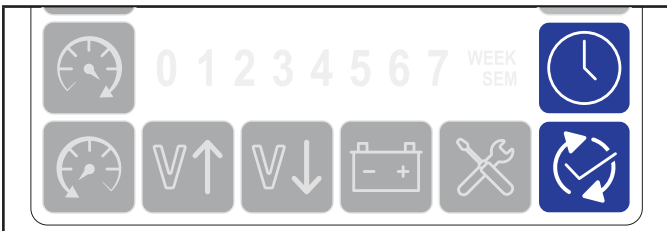

Hour Meter



The hour meter keeps track of all running time of the HSB. This includes run time during a utility power outage and during the weekly exercise cycle. This provides the owner with a record of operating time which is useful in keeping track of scheduled maintenance intervals. Refer to the scheduled maintenance chart. The hour meter can't be reset. The initial time registered on the meter when first started up (installed) will reflect the factory test time, this is a normal industry standard. The hour meter only reflects hours, it does not reflect RPMs or any other function.

Exercise Icon



The BLUE icons will be lit when the HSB is performing the exercise period. Refer to "Setting Exercise Time" to establish the weekly exercise period. When the exercise period is complete the icon will turn off and the HSB will resume its standby monitoring. The aXis Controller must be in the AUTO mode in order to exercise.

aXis CONTROLLER FAULT ICONS



Low Oil Pressure Shutdown

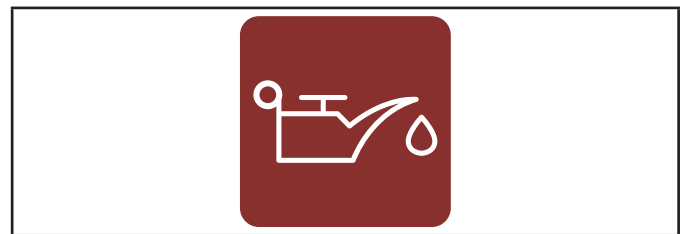

The RED icon will be lit when the engine oil pressure drops below a safe operating level. When this fault is detected, the HSB will shut down and re-start will be disabled. RED icon on the controller module and exterior LED will be lit.

Check the oil level. The oil level should be at the FULL mark, if necessary, add oil. DO NOT overfill. Inspect the unit for a possible oil leak, if a leak is discovered, contact Champion or your nearest Authorized Champion Dealer. Follow the FAULT CODE RESET instructions to clear the fault after service.

High Engine Temperature



The RED icon will be lit if the engine operating temperature exceeds the factory preset limits. If excessive operating temperature is detected, the HSB will shut down and re-start will be disabled. The RED icon on the aXis Controller and exterior enclosure LED will be lit.

This failure could be the result of an excessive load or high ambient temperatures. Should this fault occur do the following;

1. Open the enclosure doors to increase air flow throughout the unit
2. Check oil level add oil if required
3. Inspect the interior and exterior of the enclosure for debris, leaves, etc., and remove them to increase air flow around and inside the unit.
4. Once the engine temperature falls into the normal operating range, generally 30 minutes, follow the FAULT CODE RESET instructions to clear the fault after service.
5. Close the enclosure doors and the unit is ready to run.

Over crank



The RED icon will be lit if the engine does not start after 5 attempts. This prevents the HSB from damaging itself or other related components. When the fault is detected, the HSB will shut down and re-start will be disabled. RED icon on the controller module and exterior LED will be lit.

This failure could be the result of insufficient fuel supply. Check the in-line fuel shut off valves and make sure they are in the ON/ OPEN position. Position them in the correct position, follow the FAULT CODE RESET instructions to clear the fault after service. If they are in the correct position and the HSB shows a fault light again, it's recommended to perform a Manometer pressure check by an Authorized Champion Dealer or installer. This will make sure the correct amount of fuel is being delivered to the HSB when it starts.

Insufficient battery output could result in poor cranking cycles, not permitting the engine starter to reach optimum starting RPM to start the engine. This can be verified by checking the Battery Charger icon, NO CHARGE. If this occurs, the individual battery voltages must be checked to determine if the batteries are properly charged or if they have failed. It is extremely important to follow all cautions and warning per the battery manufacturer concerning installation, service, maintenance and replacement procedures.

Hz Over speed/Under speed

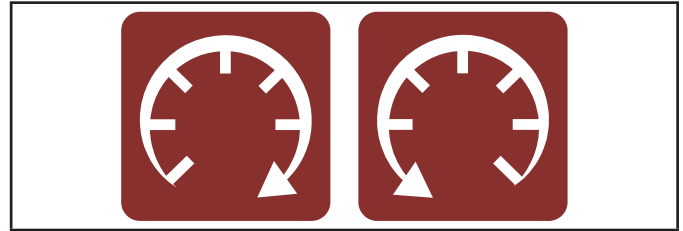

The RED icon will be lit if the engine was operating above or below its preset speed limits. These limits are factory set to protect the HSB and the circuits connected to the generator output circuits. When this fault occurs, the HSB will shut down, light the RED icon, shut down and re-start will be disabled. The exterior fault LED on the back of the HSB enclosure will be activated and lit.

If this failure occurs, contact Champion or your Authorized Champion Dealer. The RED icon will remain lit until the failure has been corrected, the HSB will not attempt to transfer or run.

Line Over Voltage

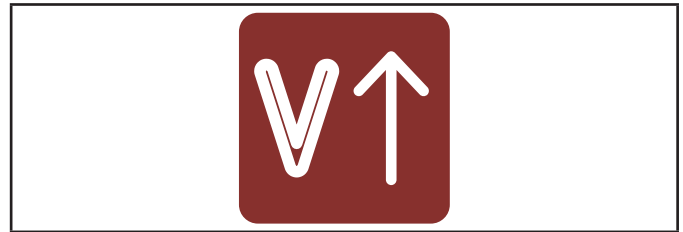

The RED icon will be lite if the HSB generator output power exceeds preset limits of 257 VAC.

When this fault occurs, the HSB will light the RED icon, shut down and re-start will be disabled. The exterior fault LED on the back of the HSB enclosure will be activated and lit. Check and adjust AVR. Set Voltage to 240 VAC.

Line Under Voltage

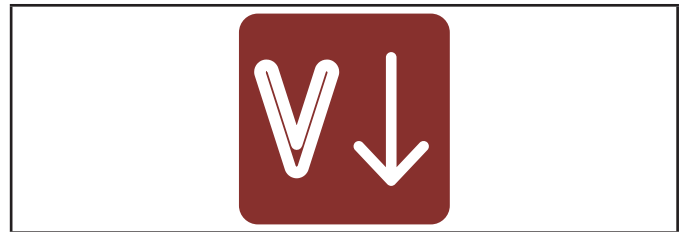

The RED icon will be lit if the HSB Generator output power is below preset limits.

When this fault occurs, the HSB will light the RED icon, shut down and re-start will be disabled. The exterior fault LED on the back of the HSB enclosure will be activated and lit. Check and adjust AVR. Set Voltage to 240 VAC.

Low Battery

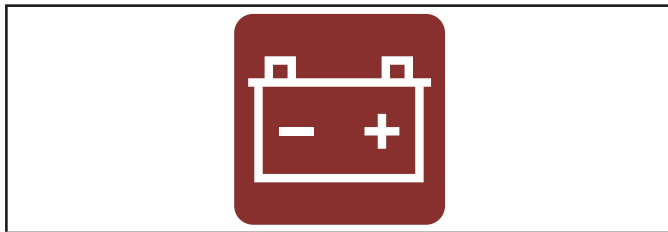

The RED icon will be lit if the battery voltage falls below 21.0 volts for at least 5 seconds while the engine is running. If the battery voltage rises above 22 volts, the icon will turn off. Battery voltage is NOT monitored when the engine is cranking, just when the engine is running. If the RED icon comes on it will not shut the HSB off, it will remain lit until the battery condition meets the required output.

When the icon remains lit, the battery charging should be checked and the condition of the batteries. Follow the FAULT CODE RESET instructions to clear the fault after service.

Requires Maintenance



The RED icon will be lit if the HSB generator is ready for maintenance.

The maintenance hour meter counts from 100 hours to 0. You need to reset when the hour meter reaches 0. Refer to the scheduled maintenance chart.

Refer to “Resetting the maintenance hour meter” for instructions after performing maintenance.

FAULT PROTECTION

In all cases when the icon is RED, this is an indicator that the HSB has registered a fault and must be corrected. Only the “LOW BATTERY” and “MAINTENANCE” icons will not latch out or shut down the HSB. ALL other RED icon faults will latch out, shut down, disable starting and light the RED icon on the aXis Controller and the Exterior Fault Code Indicator Light on the backside of the HSB.

APPROXIMATE ENGINE STARTER CRANK CYCLE TIMES

10 seconds ON

10 seconds OFF

(5 Cycles Total)

If the HSB fails to start, the “OVER CRANK” icon will be lit on the aXis Controller and the exterior fault code indicator icon on the backside of the HSB.

FAULT CODE RESET

In the event a fault has occurred push OFF button to reset then AUTO button to re-arm.

⚠ WARNING

All faults should be taken seriously and corrected before reset process is performed.

Wi-Fi Setup Method

1. Use a Wi-Fi enabled device (laptop, smart phone, tablet, etc.) in near proximity to the ATS.
2. Search and connect to network name (SSID) “Champion ####” where #### will match the last four digits of the serial number that is printed on the control board.

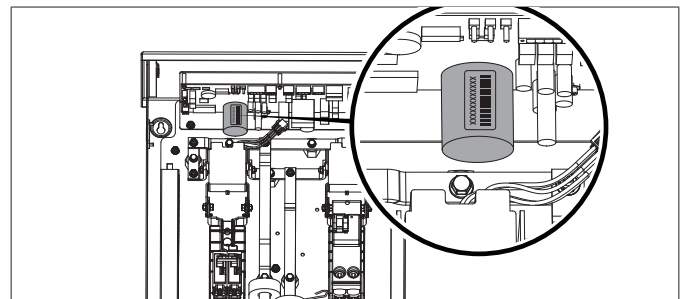

2a. The password for the network is located on a label on the dead front of the ATS.

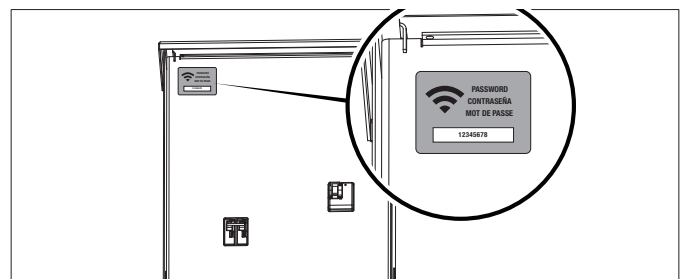

🗨 NOTICE

During the setup your device will disconnect from the internet. The Champion Wi-Fi is a direct connection between your device (laptop, smart phone, tablet, etc.) and the ATS, and it does not connect to the internet. Some Android devices may show the following screen – Choose “Connect only this time.”



Internet may not be available.

If you want to connect this network without internet access, you can connect only this time or you can set your phone to always connect to it even if internet isn't available.

You can change this in Settings > Connections > Wi-fi > ADVANCED > Switch to mobile data > Network exceptions

[Connect only this time](#)

[Allow switch](#)

[Stay connected](#)

3. After connecting Wi-Fi, open your device's web browser. In the browser address change the address to 192.168.0.90 and begin search. This will direct your browser to the Champion aXis Controller® Home Standby Generator Settings page located on the ATS. If your device's web browser does not load the Champion aXis Controller® Home Standby Generator Settings Page but rather stays connected to the internet, turn off mobile data on the device (if applicable) and make sure the device is not connected to any other networks.



10:10

192.168.0.90

4. On the Champion aXis Controller® Home Standby Generator Settings Page, set the date and time. Use either the dropdown boxes or the "USE THIS DEVICE DATE & TIME" button to set the time and date.



USE DEVICE DATE & TIME ⓘ

Date:

Choose Month... ▾

Choose Date... ▾

Choose Year... ▾

Time:

Choose Hour... ▾

Choose Minute... ▾

Choose AM/PM... ▾

CONFIRM DATE & TIME ➤

5. Confirm and apply the settings before continuing. If you do not apply immediately, the clock will be later than actual. Unsaved changes are highlighted.

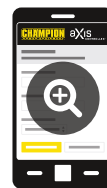

Date March 22, 2022 *Unsaved Changes*

Time 08:40 AM *Unsaved Changes*

Day Light Saving On *Unsaved Changes*

EDIT DATE & TIME ✎

Generator Exercise
(Automated Maintenance Running)

Frequency: Every Week

Day: Friday

Time: 09:00 AM

EDIT EXERCISE FREQUENCY ⬆

✓ APPLY **✕ REVERT**

- Some operating systems will require additional steps to confirm update, accept all pop-up windows until progress bar is seen on screen.

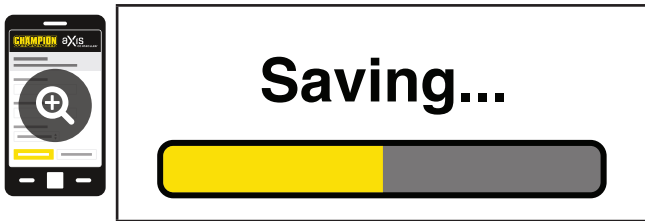
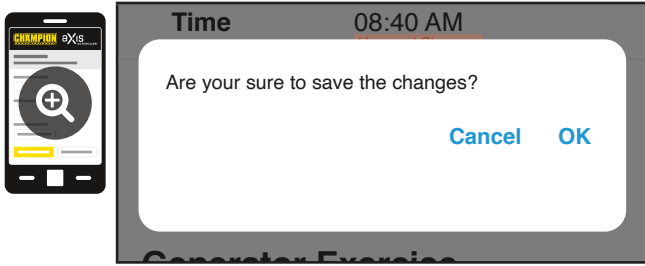

- Set the HSB exercise frequency and schedule.

NOTE: Exercise duration is system set at 15 minutes. The duration is not adjustable. The aXis Controller must be in the AUTO mode in order to exercise.

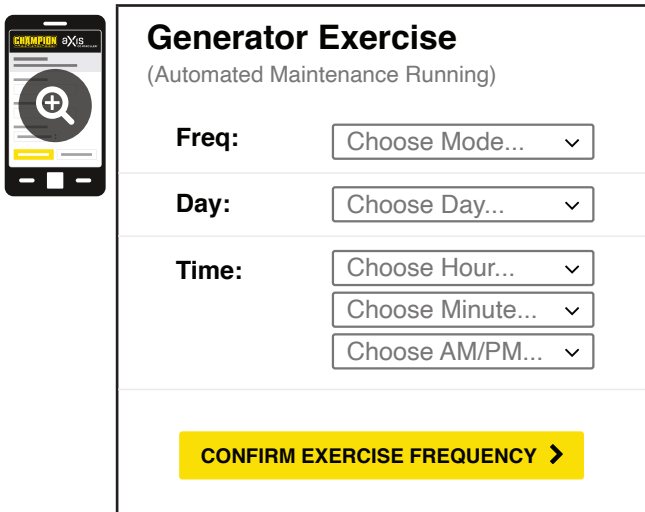

- Confirm and apply the settings before continuing. Unsaved changes are highlighted.

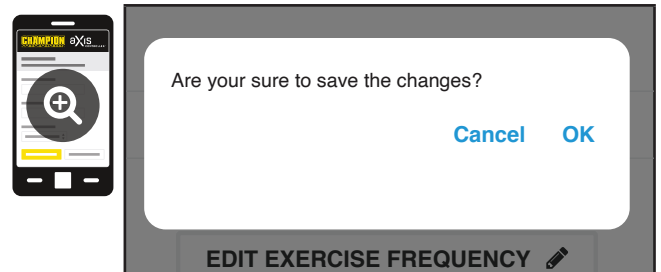
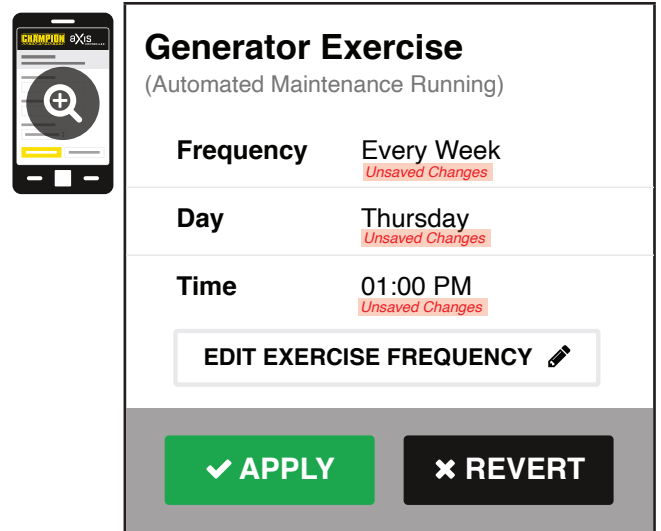



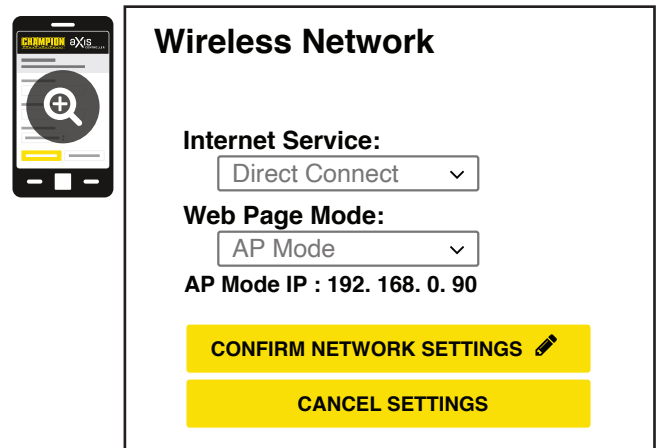

- Wireless network settings are not used at this time. The default values (shown below) should not be adjusted. Adjustment of this factory settings will require a certified electrician to correct.



- The time, date, and exercise information have now been setup for the aXis ATS and HSB. You can close your browser and disconnect from the ATS Wi-Fi, or skip to step 2 in the next section "ATS and HSB STATUS USING WI-FI"

ATS and HSB Status Using WIFI

- Using a WIFI enabled device, connect to the “Champion HSB” WIFI network following steps 1, 2, and 3 from WIFI Setup Method.
- After loading the Home Standby Generator Settings page, locate and click the  icon at the bottom right corner of the page.
- You are now viewing the ATS and HSB status page. Items such as voltage, frequency, current, etc. can all be viewed for both utility and HSB power. All of the information is live. There are three tabs located at the top of the page.    ATS, GEN, and LMM. Each tab will display the status for the Transfer Switch, Home Standby Generator, or Load Management Module(s) respectively.
- When finished viewing the status of the ATS, Generator, and LMM, close your browser and disconnect from the WIFI.

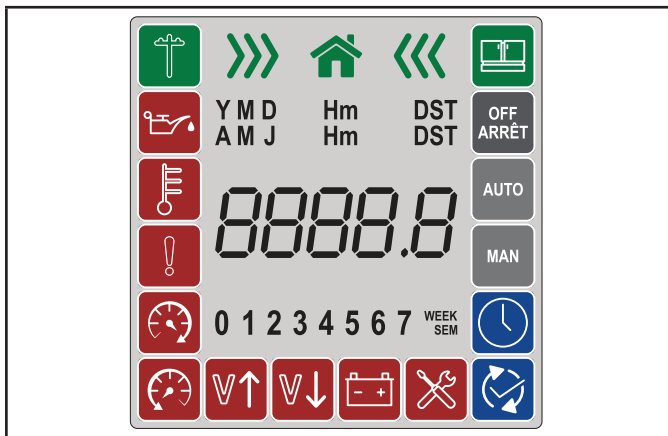

Programming aXis Controller®





















NOTICE

Setting values are not autosaved. You must press OFF to save the changes and exit the programming.

Please wait for the decimal point to stop flashing before moving on to the next function. If you hit  too soon while the decimal point is still flashing, it does not save the change.

- To begin programming, disable AUTO by selecting OFF .
- After the HSB is set to OFF, press and hold  until the screen changes (decimal point will flash) to enter programming mode. The display will show YA for year and the clock icon  will illuminate.

Please wait for the decimal point to stop flashing before moving on to the next function. If you hit  too soon while the decimal point is still flashing, it doesn't save the change.

- Year (Y)** - choose current year (example 2021 would be 21) with 18 to 47.
 - Set year using 
 -  for next
- Month (M)** - choose January to December with 1-12.
 - Set month using 
 - 
- Day (D)** - choose the day from 1 to 31.
 - Set day using 
 - 
- Week Day** - choose week day from 1 to 7.
 - Set week using 
 - 1= Monday
 - 2= Tuesday
 - 3= Wednesday
 - 4= Thursday
 - 5= Friday
 - 6= Saturday
 - 7= Sunday
 - 
- Hour (H)** - choose hours in military time 0 - 23.
 - Set hour using 
 - 
- Minute (m)** - choose the minute from 0-59.
 - Set minute using 
 - 
- Daylight Saving Time (DST)** - choose DST on (1) or off (0).
 - Set DST using 
 - 
- Maintenance Hour Meter (H)** - choose hours in 10 to 99. Factory setting is 100, you can elect to have this maintenance reminder more often here.
 - Set maintenance hour meter using 
 - 
- Exercise**
 - Set exercise schedule using 
 - 0= no exercise
 - 1= 1 time per month (12 times annually)
 - 2= 2 times per month (24 times annually)
 - 3= 4 times per month (48 times annually)
 - 4= weekly (52 times annually)
 - 

Week Day (exercise)

Set week using 

- 1= Monday
- 2= Tuesday
- 3= Wednesday
- 4= Thursday
- 5= Friday
- 6= Saturday
- 7= Sunday
- ☑ for next

Hour (exercise) - choose hours in military time 0 - 23.

Set hour using 

☑ for next

Minute (exercise) - choose the minute from 0-59.

Set minute using 

☑ for next

12. When finished, press OFF to save all changes.

Battery Charger

The LEDs on the battery charger indicate the state of the battery's charge level. Battery charger rating 24 Vdc 1.6A.

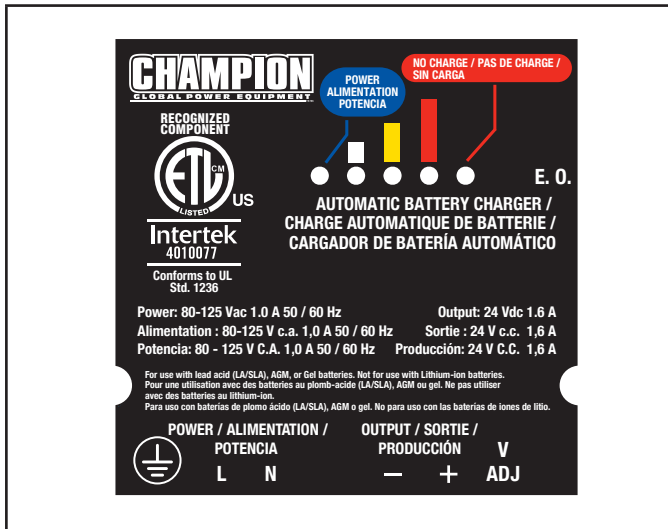

Power	Lit to indicate the battery is fully charged.
Small Bar	Lit to indicate the battery is receiving a trickle charge
Middle Bar	Lit to indicate current output is near 50%.
Large Bar	Lit to indicate the charger is operating above 50% capacity.
No Charge	Lit to indicate a battery charging problem. If this LED is lit, the LED on the aXis Controller®, "LOW BATTERY" will also be lit.

Emission Requirements

This engine-powered generator meets all United States Environmental Protection Agency (EPA) Phase 3 requirements and is approved for use in both the USA and Canada.

This generator is certified to operate on pipeline NG and LPG (vapor) fuel for use as a stationary engine for standby power generation. Federal and/or local laws may be violated if it is used for any other purpose.

The maintenance schedule must be followed to ensure that the engine complies with the applicable emission standards for the duration of the engine's life.

NOTICE

For Emission control devices and systems, read and understand your responsibilities for service as stated in the Emission Control Warranty Statement of this manual.

Specifications

Home Standby Generator	
Maximum continuous power, LPG	14 kW
Maximum continuous power, NG	12.5 kW
Rated voltage	120/240
Amps	116.6/58.3 LPG (propane), 104/52 NG (natural gas)
Harmonic distortion	Less than 5%
Main line circuit breaker	65 amp
Phase	Single
Frequency	60 Hz
Unit weight	438.7 lb. (199 kg)
Size (L x W x H)	49 x 28 x 28 in. (124.5 x 71 x 71 cm)
Engine	
Type	Milwaukee Series OHV Commercial V-Twin
No. of cylinders	2
Displacement	754 cc
Cylinder block	Aluminum with cast iron sleeves
Ignition system	Solid state – magneto
Spark plug	F7RTC (NGK BPR7ES)
Governor	Mechanical
Starter	Electric 24V DC
Oil capacity	1.6 qt (1.5 L)
Oil Type	5W-30 Full Synthetic*
RPM	3600
Controls	
Mode switch auto	Auto start on utility failure
Mode switch manual	Starts on demand
Mode switch off	Stops unit/control and charger active
Ready to run/maintenance messages	Standard
Programmable start delay	Standard
Engine start sequence	Standard
Starter lockout	Standard
Battery charger/low battery indicator	Standard
Charger fault	Standard
AVR over voltage protection	Standard
Low oil protection	Standard
Safety fused	Standard
Overcrank/overspeed/underspeed protection	Standard

*Serial Number **Y2212150069+**: Unit comes with oil pre-filled in unit.

Serial Number < **Y2212150069**: Unit does not come with oil. You must ADD OIL before starting the unit.

** After 5 hours, change oil per maintenance schedule. The recommended oil type for typical use is 5W-30 full synthetic oil. However, using the listed conventional oils shown in the "Recommended Engine Oil Type" chart may be used for typical use. If running generator in extreme temperatures, refer to the "Recommended Engine Oil Type" chart.

Fuel System

The engine is fitted with a dual master mixer assembly carburetion system, which allows it to run on either NG or LPG. It has been configured at the factory to run on NG. If your installation requires the engine to run on LPG, orifices in the master mixer assembly carburetor must be changed.

Battery Requirements

Two (2) 12 volt Group U1L batteries. Battery size: 7 3/4 L x 5 3/16 W x 7 5/16 H inches (196mm L x 131mm W x 185mm H). Purchase batteries locally.

The recommended battery type for typical use is **350 CCA**. This is based on testing in extreme cold and heat -22° F (-30° C) to 104° F (40° C). However, a 300 CCA shown in the “Recommended Battery Type” chart may be used for typical use, if in regularly warmer climates.

Recommended Battery Type					
	← 350 CCA min →				
	← 300 CCA min →				
°F	-40	-4	32	68	104+
°C	-40	-20	0	20	40+
Ambient temperature					

Install positive cable first. Install a cable from the positive (+) terminal of one battery to the negative (-) terminal of the other battery. Always connect the positive (+) battery cable to the generator first.

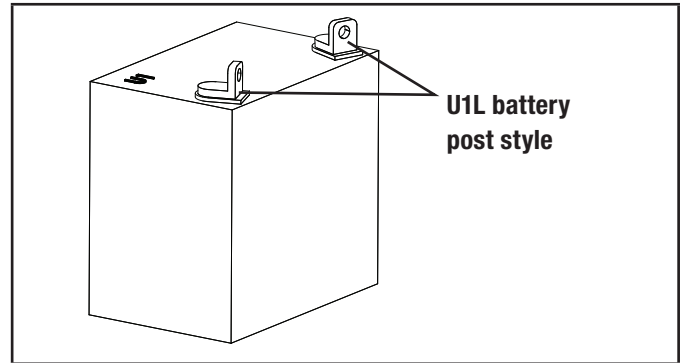
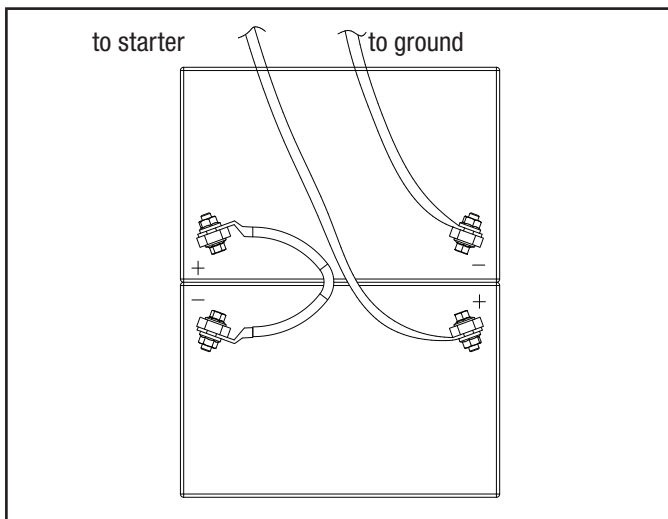

⚠ CAUTION

For battery installation, maintenance, and safety requirements refer to purchased manufacturer battery installation and safety manual.

Battery Charging

The generator is equipped with an automatic battery charger. The charger will sense the battery’s state of charge and automatically charge the battery when required. LED lights on the charger display the battery state of charge.

Model and Serial Number

The model and serial number plate is affixed to the generator above the control panel. Have this information if calling for service or ordering parts.

STATIONARY ENGINE DRIVEN GENERATOR / STATIONNAIRE GÉNÉRATEUR ENTRAÎNÉ PAR UN MOTEUR / GENERADOR ACCIONADO POR MOTOR ESTACIONARIO		MODEL / MODELE / MODELO 100515	
RATED VOLTAGE	120/240~single-phase	TENSION NOMINALE	120 / 240~monofásicas
RATED FREQUENCY	60 Hz	FRECUENCIA NOMINALE	60 Hz
RATED CURRENT	116.6 A / 58.3 A (LPG)	CORRIENTE NOMINALE	116.6 A / 58.3 A (GLP)
POWER FACTOR	1.0	FACTOR DE POTENCIA	1.0
MAX LOAD UNBALANCE	50%	MAX Desequilibrio de la carga	50 %
RATED ENGINE SPEED	3600 RPM	VELOCIDAD NOMINALE DEL MOTOR	3600 RPM
RATED AMBIENT TEMP	77°-104°F (23°-40°C)	TEMPERATURA AMBIENTE NOMINALE	77°-104°F (23°-40°C)
INSULATION CLASS	H	ASLANTE CLASE	H
NEUTRAL	FLOATING	NEUTRAL	FLORANTE
FOR STANDBY SERVICE	POUR LE SERVICE DE SECOURS	PARA EL SERVICIO SUPLENTE	
RAINPROOF ENCLOSURE FITTED	BÔÎTE ETANCHE À LA PLUIE ÉQUIPÉ	CARCASA A PRUEBA DE LLUVIA EQUIPADO	
CHAMPION POWER EQUIPMENT 12039 Smith Ave., Santa Fe Springs, CA 90670 USA		 Conforms to UL Std. No. 2200 Certified to CSA Standard C22.2 No. 100	

OPERATION

Before operating the generator, review SAFETY section starting on page 8.

High Altitude

The density of air at high altitudes is lower than at sea level. Power derates at an elevation over sea level and ambient temperatures over 77 °F (25 °C) are:

General power derate is 1% for every 10 °F above 77 °F. (1% for every 5.6 °C above 25 °C)

Elevation derate is 3.5% for every 1,000 feet (304.8 m) above sea level.

No jet change is required for LPG and NG at high elevations. The zero-pressure regulator is self-compensating since it is balanced to atmospheric pressure.

Enclosure and Access

Open the enclosure to gain access to the generator and its components. Unlock the handles. Turn the handles and lift the hoods up and to the outside.



Pre-Start Checklist

To make sure the generator is ready for proper operation, the following items should be checked:

- On/Off switch is in the ON position
- Fuel valve is in the on position
- No fault code LEDs are lit
- Battery is at full charge
- aXis Controller® is in AUTO mode.
- Transfer switch is in the Utility Power position

Turning OFF the Generator

If you need to shut off the generator when it is running, put the aXis Controller in the OFF position. This will shut off the engine. With the aXis Controller in the OFF position, the generator will not start, even if there is loss of utility power.

MAINTENANCE

Before performing maintenance procedures, review SAFETY section starting on page 8.

Ensure that the ATS and Engine Switches are in the OFF position before performing any maintenance or cleaning.

Scheduled Maintenance Chart

First 5 Hours of Operation	
Change engine oil and filter - Every 100 hours oil and oil filter change are required	√
Weekly	
Check exterior fault code indicator light	√
Inspect and clean enclosure louvers	√
Monthly	
Check engine oil level	√*
Inspect fuel lines and connections	√
Inspect and clean battery terminals	√
Every 2 Years or 100 Hours of Operation	
Change engine oil and filter when maintenance light comes on	√**
Inspect and clean engine air cleaner	√**
Inspect engine spark plug	√
Reset maintenance hour meter every 100 hours	√
Complete inspection of generator, engine tune-up, and valve lash check/adjustment	√***

* Monthly or 24 hours of continuous operation

** Service sooner if operating in high ambient temperatures or a dusty and dirty environment.

*** Maintenance should be performed by your service dealer.

Spark Plug Specifications

OEM Type F6RTC
 Replacement Type NGK BPR6ES or equivalent
 Gap 0.028-0.031 in. (0.7-0.8 mm)

Oil Filter Specifications

OEM Type 101766 / 717.153000.02
 Replacement Type Fram PH3600 or equivalent

Engine Oil

ENGINE OIL REQUIREMENTS

Use American Petroleum Institute (API) Service Class SN or better. Do not use special additives.

🗨️ **NOTICE**

The recommended oil type for typical use is **5W-30 full synthetic oil**. However, using the listed conventional oils shown in the “Recommended Engine Oil Type” chart may be used for typical use.

If running generator in extreme temperatures, refer to the “Recommended Engine Oil Type” chart.

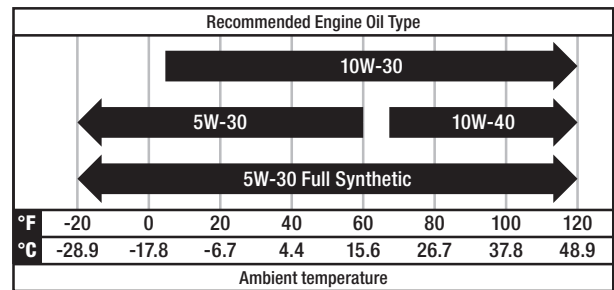

CHECKING THE ENGINE OIL LEVEL

Check the oil level daily when the generator is running for an extended period of time.

1. If the generator is running during a utility outage, turn off all household loads.
2. Put the aXis Controller in the OFF position.
3. Remove the dipstick. Wipe it dry with a clean cloth and completely reinsert it into the dipstick tube.

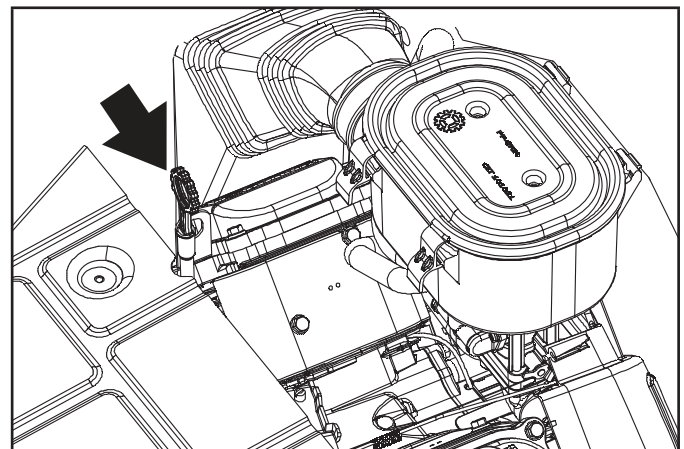

⚠️ **WARNING**

DO NOT overfill the engine with engine oil. Damage to the engine may occur.

4. Install the dipstick.
5. Remove the dipstick. The oil level should be at the FULL mark. If necessary, add oil. DO NOT overfill.

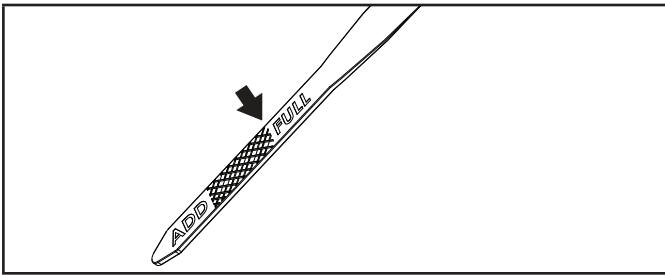

6. Put the aXis Controller in the previous position (either MANUAL or AUTO for example).

Changing the Engine Oil

⚠ WARNING

Always wear protective glasses or goggles and protective clothing when changing hot engine oil.

1. Press the MAN (Manual) button on the aXis Controller to start and run the HSB.
2. Allow the engine to run until it reaches operating temperature.
3. Press the OFF button on the aXis controller.
4. Remove the fuse from the front of the aXis Controller This will disable automatic starting in the event of a power outage.
5. Put the generator ON/OFF switch to the OFF position.

🗨 NOTICE

Always be environmentally responsible. Consult the local authorities or reclamations facility for proper disposal of engine oil waste.

6. Position drain pan under alternator.
7. Loosen hose clamp on oil drain hose and slide drain hose off retaining pin.

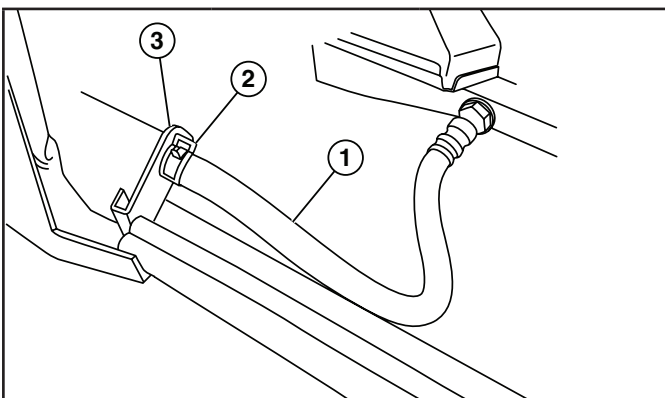

1. Oil Drain Hose	2. Hose Clamp	3. Retaining Pin
-------------------	---------------	------------------

8. Position drain hose into drain pan and allow crankcase to empty.
9. Reinstall the hose onto the retaining pin and reposition hose clamp.
10. Fill the engine with the proper amount of engine oil.
11. Reinstall fuse removed in the earlier step.
12. Turn the generator ON/OFF switch to the ON position.
13. Put the aXis Controller to the previous position (either MANUAL or AUTO for example).

Inspect and Clean Engine Air Cleaner

1. Press the OFF button on the aXis controller.
2. Remove the fuse from the front of the aXis Controller. This will disable automatic starting in the event of a power outage.
3. Put the generator ON/OFF switch to the OFF position.
4. Unsnap the clips holding the air cleaner cover in place and remove the air cleaner cover.
5. Remove the paper element.

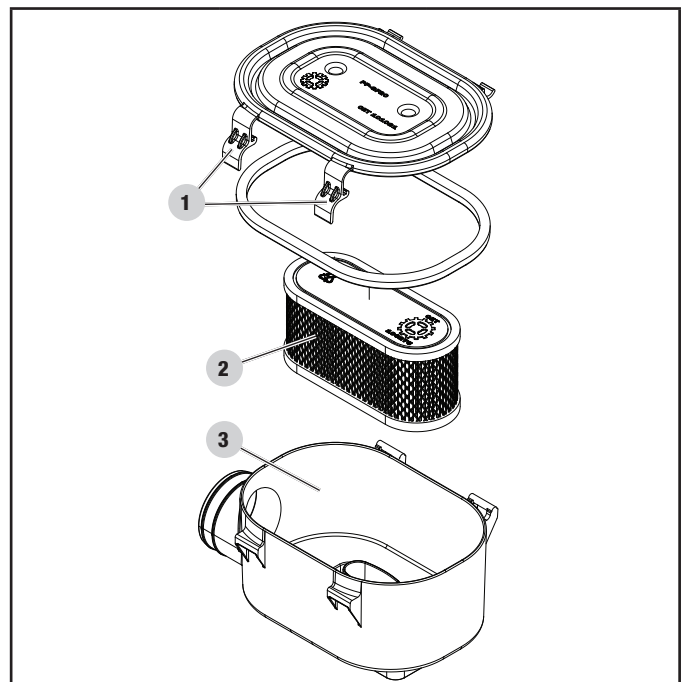

1. Air cleaner cover clips	2. Paper element	3. Air cleaner base
----------------------------	------------------	---------------------

6. Inspect the paper element for any rips or tears. Replace if damaged.
7. Hold the paper element up to a light. You should be able to see light through the paper element, if not replace the element. Inspect air cleaner cover, remove any dirt or debris.
8. Install paper element in the air cleaner housing with the pleats facing towards the air cleaner cover.
9. Install the cover and snap the clips in place.
10. Turn the engine control module switch to its prior position.

11. Reinstall fuse removed in the earlier step.
12. Put the generator ON/OFF switch to the ON position.
13. Put the aXis Controller to the previous position (either MANUAL or AUTO for example).

Spark Plug

1. Press the OFF button on the aXis controller.
2. Remove the fuse from the front of the aXis Controller. This will disable automatic starting in the event of a power outage.
3. Turn the generator ON/OFF switch to the OFF position.
4. Remove the spark plug cable from the spark plug.
5. Clean the area around the spark plug to keep dirt out of the engine and remove the spark plug.
6. Inspect the spark plug electrode and replace the plug if the electrode shows signs of deterioration.
7. Check the gap before installing the spark plug. The spark plug gap should be 0.028 – 0.031 in. (0.7 – 0.8 mm).

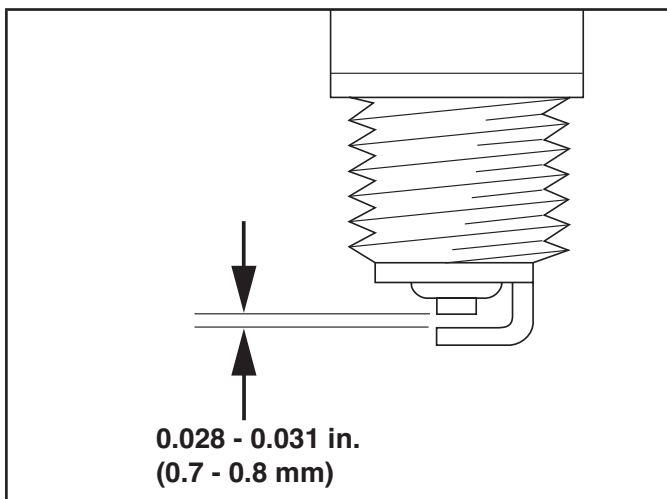

8. Carefully thread the spark plug into the engine and tighten to 20-30 N-m (14.8-22.1 lbf-ft).
9. Re-connect the spark plug cable.
10. Reinstall fuse removed in the earlier step.
11. Put the generator ON/OFF switch to the ON position.
12. Put the aXis Controller to the previous position (either MANUAL or AUTO for example).

Battery Maintenance

1. Turn the engine control module switch to the OFF position.
2. Inspect the battery cables and terminals for corrosion.
3. Check that the cables are securely fastened to the terminals.
4. Check the ground lug and make sure the connections are tight.

5. Check the fluid level of the battery, unless sealed. If low, top off the level using distilled water only.

Follow all battery instructions provided by the battery manufacture.

Resetting the Maintenance Hour Meter

The maintenance hour meter counts down 100 hours. Once completed the 100-hour maintenance, refer to below to reset the hour meter.

Refer to the scheduled maintenance chart for specific maintenance.

1. Locate the aXis CONTROLLER.

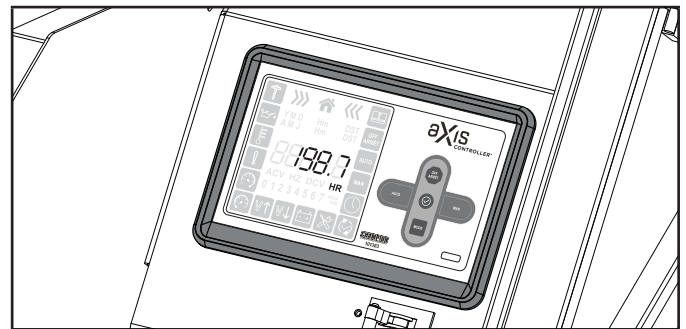

2. Press OFF to take the generator off standby allowing you to enter setting mode.

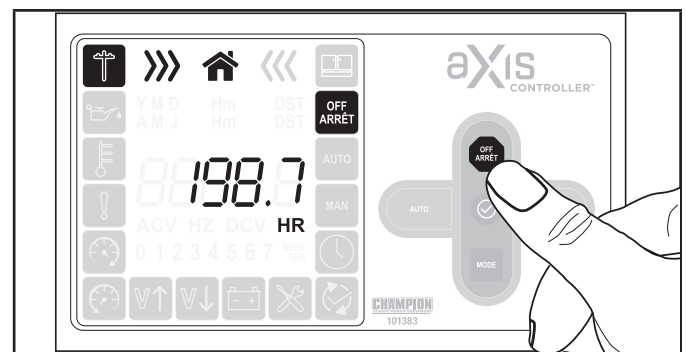

3. Press and hold  for five (5) seconds to enter setting mode.

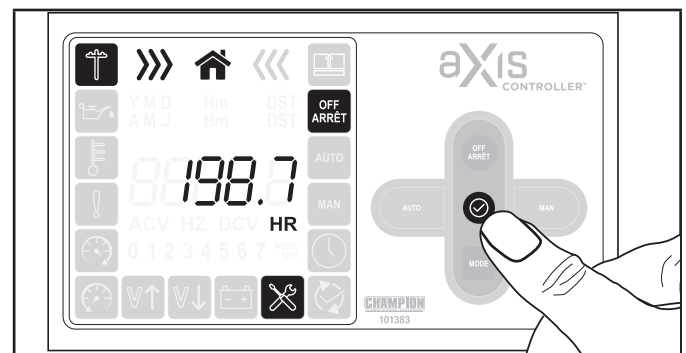

4. Cycle through until you reach maintenance hours (H) by pressing the  button. Look for the maintenance icon to be highlighted, lower right. Example shows 0 hours left for maintenance. Time for reset the count down clock.

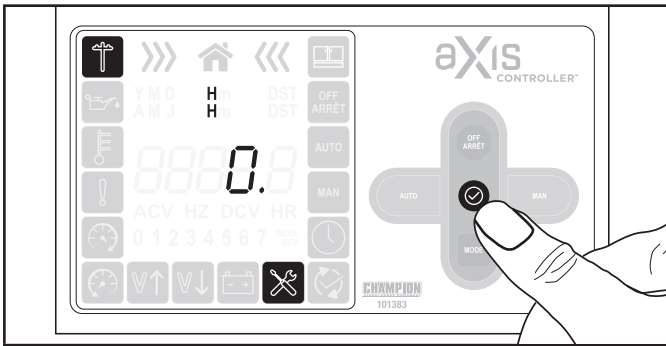

5. Press and hold AUTO button for approximately 5 seconds or until you see hour meter reset to 100. Release button.

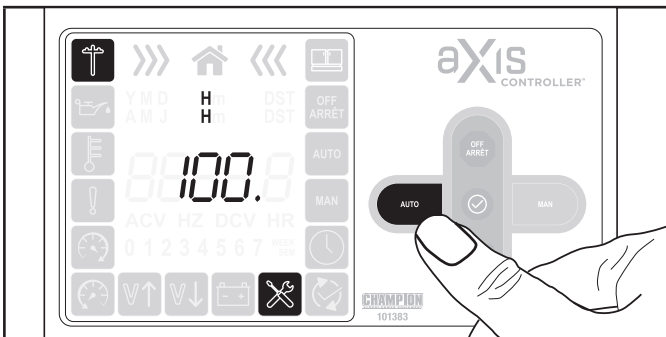

6. You have now reset the maintenance hour meter to 100 hours and can press OFF to exit.

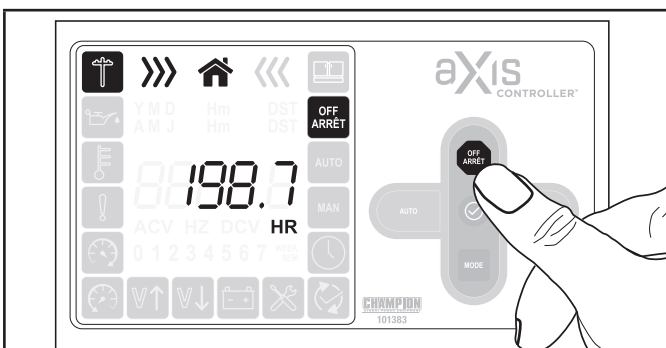

7. Press AUTO once and the system goes in standby mode.

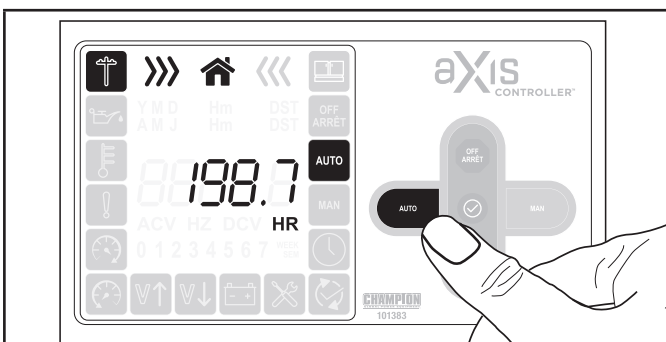

Corrosion Protection

NOTICE

Never use a pressure washer to wash the interior of the generator with water.

Wash the outside of the enclosure using a mild soap and water. Use an automotive-type wax and wax the outside of the enclosure to protect it from the elements. If used in a salt water/coastal area, the enclosure should be washed more frequently to prevent corrosion. Spray light oil on the hinges for the enclosure doors.

Maintenance After Submersion

WARNING

Never try to start or operate the generator if it has been submerged underwater or exposed to a flood.

If the generator has been in conditions where it became submerged underwater, the generator must be inspected and maintenance must be performed before returning the generator to service.

Turn engine control module and ATS control module to the OFF position. Have a authorized Champion Dealer inspect the generator and perform any necessary maintenance.

If the house or building has been exposed to a flood, it should be inspected by a certified electrician for any electrical problems that may occur if the generator is put back into service or if utility power is restored.

Storage

If the generator is not going to be used for several months and not exercised every 7 days, it should be prepared for storage.

1. Manually start the engine and run it for several minutes to allow it to warm up.
2. With the engine running, turn the fuel shutoff valve to the closed position and let the engine continue to run until it shuts down.
3. Once the engine has shut down, press the OFF button on the aXis controller. Put the generator ON/OFF switch to the OFF position.
4. Switch the generator's main circuit breaker to the OFF (OPEN) position.
5. Turn off the utility power to the transfer switch.
6. Disconnect the battery cables. Remove the negative cable first.
7. Change the engine oil. See Changing the Engine Oil on page 26.

8. Remove the spark plug and spray fogging oil into the spark plug hole. Install the spark plug and tighten.
9. Thoroughly wash and wax the exterior of the generator enclosure. Do not use a pressure washer.

Return to Service after Storage

1. Make sure the utility power to the transfer switch is off.
2. Make sure the generator ON/OFF switch is in the OFF position.
3. Remove the fuse from the front of the aXis Controller. This will disable automatic starting in the event of a power outage.
4. Put the aXis Controller to either MANUAL or AUTO for example.
5. Check the engine oil level. Add oil if needed.
6. Recharge the batteries to 100% state of charge. If the batteries will not fully charge, replace the batteries.

WARNING

Always connect the positive (+) battery cable first. After the positive cable is connected, then the negative (-) battery cable can be attached. This minimizes the possibility of electrical contact.

7. Connect the positive (+) battery cable to the positive (+) battery terminal first and then connect the negative battery cable to the negative (-) battery terminal.
8. Clean and wipe down the generator with mild soap and water.
9. Turn the fuel shutoff valve to the ON position.
10. Press the MAN (Manual) button on the aXis Controller to start and run the HSB. The engine should start. Run the engine for 15 minutes to allow it to warm up. The fuel system might require more than one start cycle to fully pressurize the fuel system for operation.
11. Make sure there are not any active fault codes.
12. Press the OFF button on the aXis controller.
13. Turn the generator ON/OFF switch to the OFF position.
14. Turn on the utility power to the transfer switch. Check the icons on the aXis Controller.

TROUBLESHOOTING HSB

Engine will not crank/turn over		
1	HSB set in "OFF" mode.	Place the HSB controllers in the AUTO position.
2	Battery not connected or loose, corroded posts or wires	Connect the batteries according to owner's manual, clean and tighten the battery connections
3	Battery(s) not charged or low charge.	Recharge or replace battery(s).
4	Check for active fault code.	Identify fault code, correct and reset.
5	Defective starter solenoid *	
6	Defective starter *	

Generator will crank/turn over but will not start		
1	Check for active fault code.	Identify fault code, correct and reset.
2	Fuel valve(s) turned off.	Turn on fuel supply.
3	Fuel pressure insufficient*.	Manometer check, confirm fuel pressure to fuel regulator*.
4	Weak battery(s).	Recharge or replace battery(s)
5	Low oil level.	Check for oil leaks. Check the oil level and add oil if necessary.
6	Spark plug wire is disconnected.	Connect spark plug wire.
7	Defective fuel solenoid/regulator. *	

Engine starts, runs rough		
1	Fuel pressure insufficient*.	Manometer check, confirm fuel pressure to fuel regulator*.
2	Wrong fuel jets.	Check jets for NG or LPG, change to correct Master Mixer fuel jets.
3	Faulty spark plug, loose spark plug wire.	Change spark plug, set gap, connect wire.
4	Plugged air cleaner	Clean or replace air cleaner.
5	Generator overloaded*.	Remove one or more loads*.
6	Shorted circuit *	

HSB starts, then suddenly stops		
1	Check for active fault code.	Identify fault code, correct and reset.
2	Fuel supply insufficient*	Manometer check, confirm fuel pressure to fuel regulator*.
3	Low oil pressure shut down.	Check for oil leaks. Check the oil level and add oil if necessary.
4	Generator over loaded.	Turn off standby circuits for house, reset fault, place unit back into AUTO mode. Turn on standby circuits for house. If problem returns contact Champion or Champion service dealer*.
5	Engine high/over temperature shut down.	Check all intake and exhaust ventilation around the HSB, remove all debris. Let HSB sit for 30 minutes to cool down.

No AC output		
1	Circuit breaker in "OFF" position	Turn on breaker.
2	Main circuit breaker in "OFF" position.	Turn on breaker.
3	Transfer switch breaker in "OFF" position.	Turn on breaker.
4	Standby breakers set in "OFF" position.	Turn on breaker.
5	Line circuit tripping breaker because of short circuit *	
6	Line circuit tripping breaker because of overload *	
7	Poor wiring connections*	
8	ATS problems*	

Reset fault code(s)

There is an exterior fault code indicator light located on the back of the enclosure. This should be checked weekly to make sure there are no active fault codes.

Maintenance		
1	The maintenance hour meter counts from 100 hours to 0. You need to reset when the hour meter reaches 0.	Refer to "Resetting the maintenance hour meter" for instructions after performing maintenance.

BATTERY(S) NO OR LOW LEVEL CHARGED, BATTERY(S) DEAD, NEEDS REPLACEMENT, THE EXERCISE TIME MUST BE RESET ONCE THE BATTERY(S) HAVE BEEN DISCONNECTED.

***Contact Champion Power Equipment, Technical Service toll free 1-877-338-0999, tech@championpowerequipment.com or your nearest Champion dealer.*

www.championpowerequipment.com

ADDITIONAL INFORMATION

Identify/Select Standby Circuits

Identify the basic needs

It is very important to understand what items the home owner wants powered by the HSB during a utility failure. The selection of these items will indicate which circuits will be selected for connection to the ATS so that they are powered by the HSB. Unforeseen power outages can last from minutes to days, so it is important to focus circuit selections on those that power household items that are deemed essential and within the output capability of the HSB.

An authorized or certified dealer or electrician can come to your home and measure the loads with a clamp-on AMP meter which would provide accurate load demands for each circuit tested.

Once you have identified the customer needs, you can properly size the HSB by referring to the sizing guide provided by Champion, www.championpowerequipment.com or call Champion 1-877-338-0999.

Circuits must be protected by the same size breaker. For example, a 15 amp 120 volt circuit in the ATS will replace a 15 amp 120 volt circuit in the main utility distribution panel. When tied together or backed up, the breakers must be the same size.

Surge Protection

⚠ CAUTION

Voltage fluctuation may impair the proper functioning of sensitive electronic equipment.

Electronic devices, including computers and many programmable appliances use components that are designed to operate within a narrow voltage range and may be affected by momentary voltage fluctuations. While there is no way to prevent voltage fluctuations, you can take steps to protect sensitive electronic equipment.

1. Install UL1449, CSA-listed, plug-in surge suppressors on the outlets feeding your sensitive equipment. Surge suppressors come in single or multi-outlet styles. They're designed to protect against virtually all short-duration voltage fluctuations.

Customer Familiarization Summary

It's important to educate the home owner on proper maintenance, operation and service call procedures. A properly educated home owner can reduce unnecessary service trips and phone calls.

Ensure that the installation of the HSB and ATS has been correctly performed as outlined by the manufacturer and that it meets all applicable codes.

Test and confirm proper operation of the HSB and ATS system as outlined in the appropriate installation and owner's manuals.

Educate the home owner on the location and operation of;

- Full flow shutoff valve
- Automatic operation of the HSB system
- Battery Charger and LED indicators
- Exterior fault code indicator LED on the backside of the HSB
- ATS operation
- Exercise scheduled time of operation
- Scheduled Maintenance
- Fill out and provide the customer a copy of the HSB, ATS model & serial number reference. This information is extremely important for part purchases and service information, these numbers are specific to each HSB and ATS.
- Fill out and provide the customer a copy of the ATS back-up circuits.
- Fill out the Circuit Label inside the ATS.

It's always a good business practice to place business cards in the Owner's and Installation manuals and place dealer stickers on the HSB and ATS for the customer's reference.

HSB, ATS Model & Serial Reference ATS Back-up Circuits

HSB Model Number _____

HSB Serial Number _____

Fuel Type LPG _____ NG _____

ATS Model Number _____

ATS Serial Number _____

ATS circuits powered _____

Date Installed _____

Dealer/Installer _____

Address _____

Phone _____

Cell _____

Purchased from _____

Maintenance and Service Record

Keeping accurate records when any service is performed is important. Records replace guessing when a repair was done or when it should be scheduled. Hour Meter notation as well as the date provides better time period records. To maintain the overall performance throughout the life of the product follow the scheduled maintenance chart contained in your owner's manual or refer to www.championpowerequipment.com. Genuine Champion parts must be used to ensure warranty coverage.

Date _____

Hour Meter _____

Service Performed _____

Record the name, address and phone number of your authorized Champion dealer

10 YEAR LIMITED WARRANTY*

Basic Warranty Provisions

Champion Air-Cooled 8.5kW – 20kW Home Standby Units USA and Canadian Models

For a period of 10 years or 2000 hours (whichever occurs first) from successful activation by an Authorized Champion Home Standby Dealer, Champion Power Equipment will, at its option, repair or replace any part(s) which upon examination, inspection and testing by Champion Power Equipment or an Authorized Champion Home Standby Dealer is found to be defective under normal use and service, in accordance with the Warranty Schedule set forth below.

Any equipment that the purchaser/owner claims to be defective must be examined by the nearest Authorized/Certified Champion Home Standby Service Dealer. This warranty applies only to Champion Power Equipment automatic standby generators used in "Standby" applications as Champion has defined Standby. Scheduled Maintenance, as outlined by the generator owner's manual is required. This Scheduled Maintenance should be performed by a knowledgeable, experience operator or an Authorized/Certified Champion Home Standby Service Dealer.

WARRANTY SCHEDULE

Years 1 and 2 – Limited comprehensive coverage on mileage, labor and parts

Years 3 through 10 – Limited comprehensive coverage on parts only

GUIDELINES:

- Warranty begins upon the successful activation of the unit.
- Unit should be Registered and Proof of Purchase and Maintenance must be available.
- Warranty is transferable between ownership of original installation site.
- Warranty only applies to permanently wired and mounted units.
- Any and all warranty repairs and/or concerns must be performed and/or addressed by an Authorized/Certified Champion Home Standby Service Dealer. Repairs or diagnostics performed by individuals other than Authorized/Certified Champion Home Standby Service Dealers not authorized in writing by Champion Power Equipment will not be covered.
- A Champion approved Transfer Switch is highly recommended to be used in conjunction with the generator set. The Champion Transfer Switch is covered under its own, separate warranty listed in the Transfer Switch Instruction Manual and is not covered under this warranty schedule.
- If a Non-Champion approved Transfer Switch is substituted for use and directly causes damage to the generator set, no warranty coverage shall apply.

- Steel enclosures are warranted against rusting for the first year of ownership only. Damage caused after receipt of generator is the responsibility of the owner and is not covered by this warranty. Nicks, scrapes, dents or scratches to the painted enclosure should be repaired promptly by the owner.
- All warranty expense allowances are subject to the conditions defined in Champion Power Equipment "Home Standby" Warranty Policy and Procedures Manual.

THIS WARRANTY SHALL NOT APPLY TO THE FOLLOWING:

- Original installation or start-up costs
- Champion Home Standby generators that utilize non-Champion Power Equipment replacement parts
- Costs of normal maintenance (i.e. tune-ups, associated part(s), adjustments, loose/leaking clamps, installation and start-up)
- Units sold, rated or used for "Prime Power", "Trailer Mounted" or "Rental Unit" applications
- Damage to generator system (including transfer switch) caused by improper installation or costs necessary to correct installation
- Units used for Prime Power in place of existing utility power (where utility power is present) or in place of utility power where utility power service does not normally exist. Prime power includes any application that does not use the utility grid for electric power (example: Solar power)
- Fuel connections other than conventional utility company supplied natural gas systems or conventional LP vapor withdrawal systems
- Any failure caused by contaminated fuels, oils or lack of proper fuels, oils or failure to perform scheduled maintenance and service the air filter
- Steel enclosures that are rusting due to the improper installation, location in a harsh or saltwater environment or scratched where integrity of paint applied is compromised
- Failures due, but not limited, to normal wear and tear, accident, misuse, abuse, negligence or improper installation. As with all mechanical devices, the Champion engines need periodic part(s) service and fluid replacement to perform as designed.
- Failures caused by any external cause or act of God, such as collision, theft, vandalism, riot or wars, nuclear holocaust, fire, freezing, lightning, earthquake, windstorm, hail, volcanic eruption, water or flood, tornado or hurricane
- Damage related to rodent and/or insect infestation
- Covered warranty labor rates are based on normal working hours. Overtime, holiday, or emergency labor costs for repairs outside of normal business hours will be the responsibility of the customer

- Any incidental, consequential or indirect damages caused by defects in materials or workmanship, or any delay in repair or replacement of the defective part(s)
- Failure due to misapplication to provide sufficient cooling air and to regularly exercise the generator under load
- Telephone, cellular phone, facsimile, internet access or other communication expenses
- Living or travel expenses of person(s) performing service, except as specifically included within the terms of a specific unit warranty period
- Expenses related to “customer instruction” or troubleshooting where no manufacturing defect is found
- Rental equipment used while warranty repairs are being performed and/or overnight freight costs for replacement part(s)
- Costs incurred for equipment used for removal and/or reinstallation of generator, (i.e.: cranes, hoists, lifts, etc.)
- Planes, ferries, railroad, buses, helicopters, snowmobiles, snow-cats, off-road vehicles or any other mode of transport deemed abnormal
- Starting batteries, fuses, light bulbs, engine fluids, and spark plugs

Contact Information

Address

Champion Power Equipment, Inc.
 Customer Service
 12039 Smith Avenue
 Santa Fe Springs, CA 90670 USA
www.championpowerequipment.com

Customer Service and Technical Support

Toll Free: 1-877-338-0999
hsb@cpeauto.com
 Fax no.: 1-562-236-9429

THIS WARRANTY AND THE ATTACHED U.S. EPA WARRANTY ARE IN LIEU OF ALL OTHER WARRANTIES, EXPRESS OR IMPLIED, INCLUDING WARRANTIES OF MERCHANTABILITY OR FITNESS FOR A PARTICULAR PURPOSE.

Any implied warranties which are allowed by law, shall be limited in duration to the terms of the express warranty provided herein. Some states do not allow limitations on how long an implied warranty lasts, so the above limitation may not apply to purchaser/owner.

CHAMPION POWER EQUIPMENT’S ONLY LIABILITY SHALL BE THE REPAIR OR REPLACEMENT OF PART(S) AS STATED ABOVE. IN NO EVENT SHALL CHAMPION POWER EQUIPMENT BE LIABLE FOR ANY INCIDENTAL, OR CONSEQUENTIAL DAMAGES, EVEN IF SUCH DAMAGES ARE A DIRECT RESULT OF CHAMPION POWER EQUIPMENT’S NEGLIGENCE.

Some states do not allow the exclusion or limitation of incidental or consequential damages, so the above limitations may not apply to purchaser/owner. Purchaser/owner agrees to make no claims against Champion Power Equipment based on negligence. This warranty gives purchaser/owner specific legal rights. Purchaser/owner also may have other rights that vary from state to state.

To obtain warranty service or your nearest Champion Home Standby Dealer call Champion Power Equipment Customer Service toll free 1-877-338-0999.

**CHAMPION POWER EQUIPMENT, INC. (CPE)
AND THE UNITED STATES ENVIRONMENT PROTECTION AGENCY (U.S. EPA)
EMISSION CONTROL SYSTEM WARRANTY**

Your Champion Power Equipment (CPE) engine complies with U.S. EPA emission regulations.

YOUR WARRANTY RIGHTS AND OBLIGATIONS:

The US EPA AND CPE are pleased to explain the Federal Emission Control Systems Warranty on your 2023 small off-road engine (SORE) and engine powered equipment. New engines and equipment must be designed, built and equipped, at the time of sale, to meet U.S. EPA regulations for small off-road engines (SORE). CPE warrants the emission control system on your small off-road engine (SORE) and equipment for the period of time listed below, provided there has been no abuse, neglect, unapproved modification, or improper maintenance of your equipment.

Your emission control system may include parts such as the carburetor, fuel-injection system, the ignition system, catalytic converter and fuel lines. Also included may be hoses, belts, connectors and other emission related assemblies. Where a warrantable condition exists, CPE will repair your small off-road engine (SORE) at no cost to you including diagnosis, parts and labor.

MANUFACTURER'S EMISSION CONTROL SYSTEM WARRANTY COVERAGE:

This emission control system is warranted for two years, subject to provisions set forth below. If, during the warranty period, an emission related part on your engine is defective in materials or workmanship, the part will be repaired or replaced by CPE.

OWNER WARRANTY RESPONSIBILITIES:

As the small off-road engine (SORE) owner, you are responsible for the performance of the required maintenance listed in your Owner's Manual. CPE recommends that you retain all your receipts covering maintenance on your small off-road engine (SORE), but CPE cannot deny warranty solely for the lack of receipts or for your failure to ensure the performance of all scheduled maintenance.

As the small off-road engine (SORE) owner, you should however be aware that CPE may deny you warranty coverage if your small, off-road engine (SORE) or a part has failed due to abuse, neglect, improper maintenance or unapproved modifications.

You are responsible for presenting your small off-road engine (SORE) to an Authorized CPE service outlet or alternate service outlet as described in (3)(f.) below, CPE dealer or CPE, Santa Fe Springs, Ca. as soon as a problem exists. The warranty repairs should be completed in a reasonable amount of time, not to exceed 30 days.

If you have any questions regarding your warranty rights and responsibilities, you should contact:

Champion Power Equipment, Inc.
Customer Service
12039 Smith Ave.
Santa Fe Springs, CA 90670
1-877-338-0999
tech@championpowerequipment.com

EMISSION CONTROL SYSTEM WARRANTY

The following are specific provisions relative to your Emission Control System (ECS) Warranty Coverage.

- 1. APPLICABILITY:** This warranty shall apply to 1997 and later model year small off-road engines (SORE). The ECS Warranty Period shall begin on the date the new engine or equipment is delivered to its original, end-use purchaser, and shall continue for 24 consecutive months thereafter.
- 2. GENERAL EMISSIONS WARRANTY COVERAGE**

CPE warrants to the original, end-use purchaser of the new engine or equipment and to each subsequent purchaser that each of its small off-road engines (SORE) is:

 - 2a. Designed, built and equipped so as to conform to U.S. EPA emissions standards for spark-ignited engines at or below 19 kilowatts.
 - 2b. Free from defects in materials and workmanship that cause the failure of a warranted part to be identical in all material respects to the part as described in the engine manufacturer's application for certification for a period of two years.
- 3. THE WARRANTY ON EMISSION-RELATED PARTS WILL BE INTERPRETED AS FOLLOWS:**
 - 3a. Any warranted part that is not scheduled for replacement as required maintenance in the Owners Manual shall be warranted for the ECS Warranty Period. If any such part fails during the ECS Warranty Period, it shall be repaired or replaced by CPE according to Subsection "d" below. Any such part repaired or replaced under the ECS Warranty shall be warranted for any remainder of the ECS Warranty Period.
 - 3b. Any warranted, emissions-related part which is scheduled only for regular inspection as specified in the Owners Manual shall be warranted for the ECS Warranty Period. A statement in such written instructions to the effect of "repair or replace as necessary", shall not reduce the ECS Warranty Period. Any such part repaired or replaced under the ECS Warranty shall be warranted for the remainder of the ECS Warranty Period.
 - 3c. Any warranted, emissions-related part which is scheduled for replacement as required maintenance in the Owner's Manual shall be warranted for the period of time prior to the first scheduled replacement point for that part. If the part fails prior to the first scheduled replacement, the part shall be repaired or replaced by CPE according to Subsection "d" below. Any such emissions-related part repaired or replaced under the ECS Warranty, shall be warranted for the remainder of the ECS Warranty Period prior to the first scheduled replacement point for such emissions-related part.
 - 3d. Repair or replacement of any warranted, emissions-related part under this ECS Warranty shall be performed at no charge to the owner at a CPE Authorized Service Outlet.
 - 3e. The owner shall not be charged for diagnostic labor which leads to the determination that a part covered by the ECS Warranty is in fact defective, provided that such diagnostic work is performed at a CPE Authorized Service Outlet.
 - 3f. CPE shall pay for covered emissions warranty repairs at non-authorized service outlets under the following circumstances:
 - i. The service is required in a population center with a population over 100,000 according to U.S. Census 2000 without a CPE Authorized Service Outlet AND
 - ii. The service is required more than 100 miles from a CPE Authorized Service Outlet. The 100 mile limitation does not apply in the following states: Alaska, Arizona, Colorado, Hawaii, Idaho, Montana, Nebraska, Nevada, New Mexico, Oregon, Texas, Utah and Wyoming.
 - 3g. CPE shall be liable for damages to other original engine components or approved modifications proximately caused by a failure under warranty of an emission-related part covered by the ECS Warranty.
 - 3h. Throughout the ECS Warranty Period, CPE shall maintain a supply of warranted emission-related parts sufficient to meet the expected demand for such emission-related parts.
 - 3i. Any CPE Authorized and approved emission-related replacement part may be used in the performance of any ECS Warranty maintenance or repair and will be provided without charge to the owner. Such use shall not reduce CPE's warranty obligation.
 - 3j. Unapproved add-on or modified parts may not be used to modify or repair a CPE engine. Such use voids this ECS Warranty and shall be sufficient grounds for disallowing an ECS Warranty claim. CPE shall not be liable hereunder for failures of any warranted parts of a CPE engine caused by the use of such an unapproved add-on or modified part.

EMISSION-RELATED PARTS INCLUDE THE FOLLOWING: (using those portions of the list applicable to the engine)

Systems covered by this warranty	Parts Description
Fuel Metering System	Fuel regulator, Carburetor and internal parts
Air Induction System	Air cleaner, Intake manifold
Ignition System	Spark plug and parts, Magneto ignition system
Exhaust System	Exhaust manifold, catalytic converter
Miscellaneous Parts	Tubing, Fittings, Seals, Gaskets, and Clamps associated with these listed systems.
Evaporative Emissions	Fuel Tank, Fuel Cap, Fuel Line (for liquid fuel and fuel vapors), Fuel Line Fittings, Clamps, Pressure Relief Valves, Control Valves, Control Solenoids, Electronic Controls, Vacuum Control Diaphragms, Control Cables, Control Linkages, Purge Valves, Gaskets, Vapor Hoses, Liquid/Vapor Separator, Carbon Canister, Canister Mounting Brackets, Carburetor Purge Port Connector

TO OBTAIN WARRANTY SERVICE:

You must take your CPE engine or the product on which it is installed, along with your warranty registration card or other proof of original purchase date, at your expense, to any Champion Power Equipment dealer who is authorized by Champion Power Equipment, Inc. to sell and service that CPE product during his normal business hours. Alternate service locations defined in Section (3)(f.) above must be approved by CPE prior to service. Claims for repair or adjustment found to be caused solely by defects in material or workmanship will not be denied because the engine was not properly maintained and used.

If you have any questions regarding your warranty rights and responsibilities, or to obtain warranty service, please write or call Customer Service at Champion Power Equipment, Inc.

Champion Power Equipment, Inc.
12039 Smith Ave.
Santa Fe Springs, CA 90670
1-877-338-0999
Attn.: Customer Service
tech@championpowerequipment.com