

AQUATru® 
 carafe smart



AQUATru® 
 carafe smart

AquaTru Carafe Smart

Owner's Manual

AquaTru.com

©2024 AquaTru, LLC. All Rights Reserved. 11.24.R2

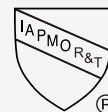

The AT100, AT110, AT120, AT130, AT140 system has been certified by IAPMO R&T against NSF/ANSI standard 42, 53, 58, 372 and 401 for the reduction claims specified on the performance data sheet as verified and substantiated by test data and at IAPMO.org



Thank You

Thank you for purchasing the AquaTru® Carafe Smart countertop water purifier! This revolutionary countertop water purifier uses reverse osmosis filtration to purify your water without installation or plumbing. AquaTru® Carafe will not only help you create healthy, delicious water, but it will also help you to eliminate single-use plastic waste from water bottles. You'll save money while saving the planet too.

Our stellar customer support team is ready to help you every step of the way, so don't hesitate to contact us at any time. If you're still not satisfied, your AquaTru Carafe Smart comes with a 30-Day Money Back Guarantee and a One-Year Limited Warranty. We hope you love your AquaTru as much as we do.

Follow us on social and visit us at AquaTru.com to find out more ways to enhance your AquaTru experience.

Please be sure to read the following instructions carefully before use to ensure optimal performance and safety.



Table of Contents

Safety Instructions	2
Features & Benefits	4
App Onboarding	5
Specifications	9
Main Parts	10
Water Filtration Process	14
Installation	15
Control Panel	18
How To Use	19
Cleaning & Maintenance	20
Cleaning & Maintenance: Filters	23
Cleaning & Maintenance: Nitrate/Nitrite Testing	27
FAQ & Troubleshooting	28
One-Year Limited Warranty	31
Arbitration Agreement	32

Read, understand, and follow all instructions and safety information in the Manual before installing and using this product. Save this Manual.

WARNING: IF NOT OBSERVED, SERIOUS PHYSICAL INJURY OR PROPERTY DAMAGE MAY OCCUR AS A RESULT OF NOT FOLLOWING THE ENCLOSED GUIDELINES.

- Do not submerge the water purifier or its power supply underwater.
- Use only on municipally treated water or any other water supply that is known to be microbiologically safe.
- Do not attempt to repair, disassemble, or modify the carafe.
- This appliance is not intended for use by persons (including children) with reduced physical, sensory, or mental capabilities, or those lacking experience and knowledge, unless they have been given instructions by a person responsible for their safety.
- Children should be supervised to ensure that they do not play with the appliance.
- The system and installation shall comply with applicable state and local regulations.
- Do not regenerate or reuse the spent absorption media.
- If absorption media is affected by chlorine, influent will be treated to remove chlorine.
- Do not use with water that is microbiologically unsafe or of unknown quality without adequate disinfection before or after the system.
- This reverse osmosis system contains a replaceable component critical to the efficiency of the system. Replacement of the reverse osmosis component should be with one of identical specifications, as defined by the manufacturer, to ensure the same efficiency and contaminant reduction performance.

READ ALL INSTRUCTIONS BEFORE OPERATING THE AQUATRU.

- Use or place the AquaTru on a leveled surface and do not apply force to the unit.
- Use or place in a cool, shady place away from sunlight. Do not keep AquaTru in bright sunlight, since the light and heat helps algae grow.
- Regular filter replacement is needed to ensure clean water.
- Do not use AquaTru filtered water for the water exchange of an aquarium or a fishbowl.
- Hand wash only. **Not dishwasher safe!**
- Household use only.
- Do not operate below 40° F.
- When placing AquaTru on a kitchen countertop, avoid placing it near hot surfaces like stoves and ovens.

NOTICE: TO REDUCE THE RISK ASSOCIATED WITH PROPERTY DAMAGE DUE TO WATER LEAKAGE:

- Read and follow these instructions before installation and use of the AquaTru.
- To protect from freezing, remove filter cartridges when temperatures are expected to drop below 40°F.
- Do not use in areas where temperatures may exceed 100°F.
- Do not place the AquaTru in direct sunlight.

FCC Statement

This equipment has been tested and found to comply with the limits for a Class B digital device, pursuant to part 15 of the FCC Rules. These limits are designed to provide reasonable protection against harmful interference in a residential installation. This equipment generates, uses and can radiate radio frequency energy and, if not installed and used in accordance with the instructions, may cause harmful interference to radio communications. However, there is no guarantee that interference will not occur in a particular installation. If this equipment does cause harmful interference to radio or television reception, which can be determined by turning the equipment off and on, the user is encouraged to try to correct the interference by one or more of the following measures:

- Reorient or relocate the receiving antenna.
- Increase the separation between the equipment and receiver.
- Connect the equipment into an outlet on a circuit different from that to which the receiver is connected.
- Consult the dealer or an experienced radio/TV technician for help.

Changes or modifications not expressly approved by the party responsible for compliance could void the user's authority to operate the equipment.

This device complies with part 15 of the FCC Rules. Operation is subject to the following two conditions:

1. This device may not cause harmful interference.
2. This device must accept any interference received, including interference that may cause undesired operation.

IC Warning

This device contains licence-exempt transmitter(s)/receiver(s) that comply with Innovation, Science and Economic Development Canada's licence-exempt RSS(s). Operation is subject to the following two conditions:

1. This device may not cause interference.
2. This device must accept any interference, including interference that may cause undesired operation of the device.

Cet appareil contient des émetteurs / récepteurs exemptés de licence conformes aux RSS (s) d'Innovation, Sciences et Développement économique Canada. Le fonctionnement est soumis aux deux conditions suivantes :

1. Cet appareil ne doit pas causer d'interférences.
2. Cet appareil doit accepter toutes les interférences, y compris celles susceptibles de provoquer un fonctionnement indésirable de l'appareil.

**The distance between user and products should be no less than 8 inches.
La distance entre l'utilisateur et le produit ne doit pas être inférieure à 20 cm.**

Features and Benefits

Advanced 4-Stage Purification System

The AquaTru water purification system utilizes powerful 4-stage reverse osmosis technology for thorough and effective purification.

Long-Lasting Filters

The filters in AquaTru have an extended lifespan, resulting in fewer filter changes. This not only saves you money over the product's lifespan but also reduces waste and promotes environmental sustainability.

Space-Saving, Compact Design

The AquaTru features an efficient and elegant countertop design that takes up minimal space in your kitchen, making it convenient for any kitchen size or layout.

Quick Filter Replacement

AquaTru is designed for easy and hassle-free filter replacement. The filters are easily accessible and removable, allowing you to quickly replace them without any complicated procedures.

Easy Installation

With AquaTru, you can start enjoying clean water in less than 10 minutes. The system is designed for straightforward installation, requiring no specialized tools or complex setup processes.

Connected Smart App

Track water usage, filter life, TDS levels and plastic bottles saved. Download and install the Apple® or Android® AquaTru app. For further information, please visit aquatruwater.com/wifi-onboard.



WiFi

App Onboarding

How To Set Up the AquaTru Smart App

Steps To Connect AquaTru

Connect AquaTru to your Wi-Fi before you install filters and run water through AquaTru. Once AquaTru is connected to your Wi-Fi, follow the setup instructions in the user manual to complete your installation of AquaTru.

Please make sure you have the name of your Wi-Fi network and password available.

Set Up an Account

- Download and install the Apple or Android AquaTru app.



Install Video
iPhone® / Android®

aquatruwater.com/wifi-onboard

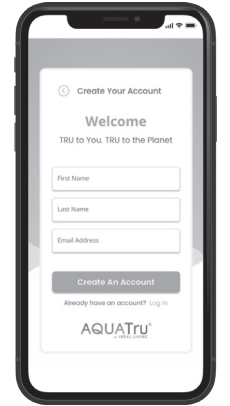

- Open the AquaTru app and click on **"Create An Account."**

STEP 2

Connect to the AquaTru Water Purifier

- Plug in the AquaTru Carafe Smart.
- Press and hold the “Reset” button for 10 seconds. The **Wi-Fi** light should start blinking blue to indicate that it is in pairing mode.  WiFi
- On an iPhone,® you will need to manually go to the phone settings to open up the **Wi-Fi** setting.
- On an Android,® you will see a **“Connect to Wi-Fi”** button on the app. Click on **“Connect to Wi-Fi”** to get to your Android® **Wi-Fi** settings.

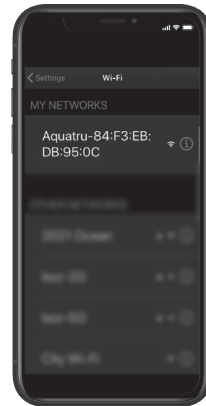
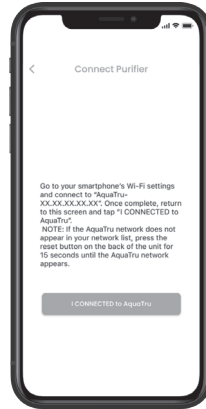

- On the **Wi-Fi** network list select the AquaTru network. The network will appear as the word **“AquaTru”** followed by a series of numbers and letters. An example can be seen here:
- After you select the network you may receive a prompt saying that this network does not have an internet connection. Accept this prompt and stay connected to the AquaTru network. Your phone should automatically switch from the network once pairing is complete.
- Now that you’ve connected to the AquaTru device, navigate back to the AquaTru app and tap **“I connected to AquaTru.”**

Connected Smart App continues on next page. 

STEP 3

Purifier Details

- Next, name your AquaTru and input purchase date.
- After this, click **“Proceed.”**
- The AquaTru will now search for a home network. **(A)**
- Select the home **Wi-Fi network** you want AquaTru to be connected to. **(B)**
- Select the network and input the password.

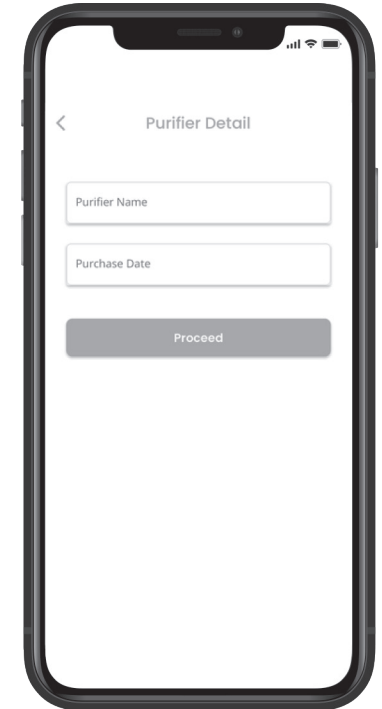
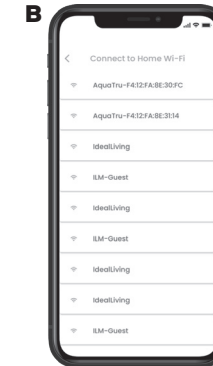

App Onboarding

AquaTru will now connect to your network. You should see this screen once the device has successfully been connected to your account.

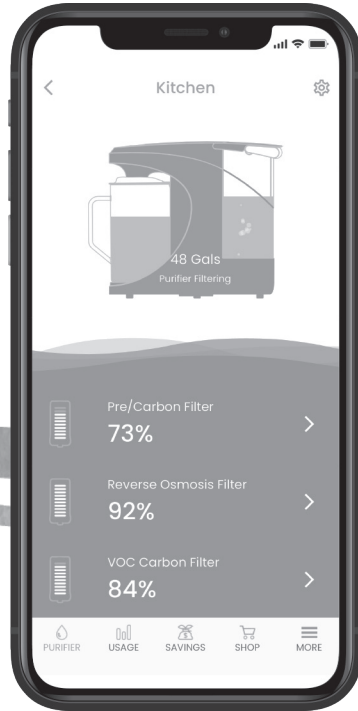

Specifications

Operational Parameters

Daily Production Rate	Rate: 39 GPD
Pre/Carbon Filter Capacity	300 gal. or 6 months
Reverse Osmosis Filter	Estimated Filter Life of 24 months or 600 gal.
VOC Carbon Filter Capacity	300 gal. or 12 months
VOC Carbon with pH + Mineral Boost Filter Capacity	300 gal. or 12 months
RO Filter Flow Rate	120mL
Operating Pressure	40-85 PSI
Use Cold Tap Water Only	40° - 100° F
Max Total Dissolved Solids	1500 mg/L
Maximum Hardness	10 gpg (171 mg/l)
Chlorine	< 2 PPM
pH	3-11
Turbidity	5 NTU Max

AQUATru®
carafe smart

Main Parts

AquaTru Carafe



AQUATru®
carafe smart

Main Parts

AquaTru Carafe

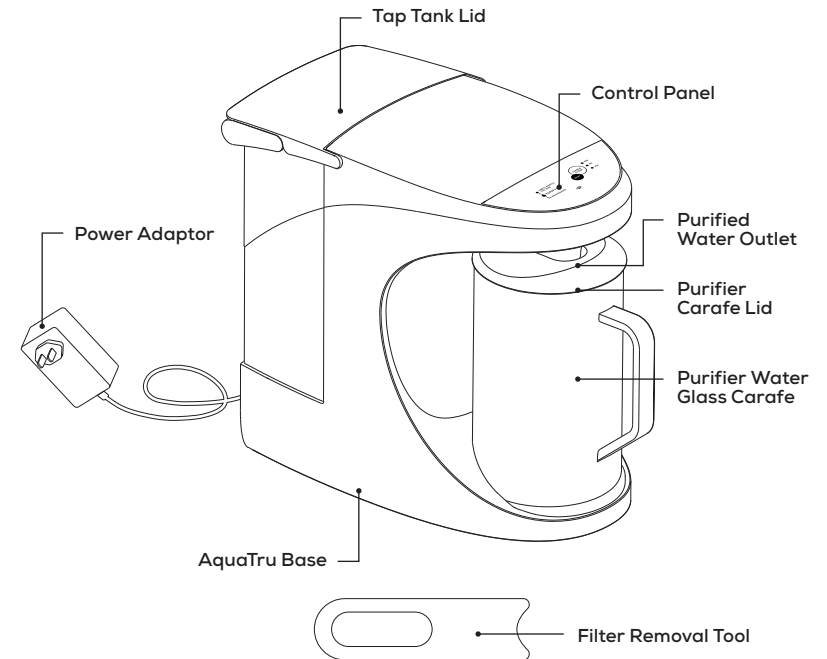

Main Parts

AquaTru Carafe

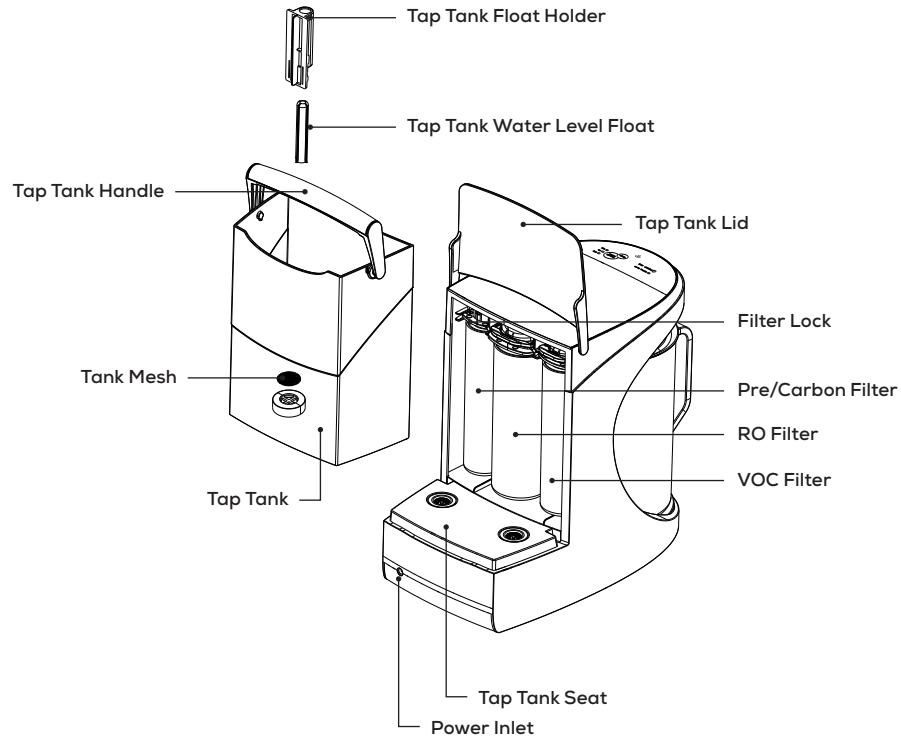

Main Parts

Purified Carafe Lid

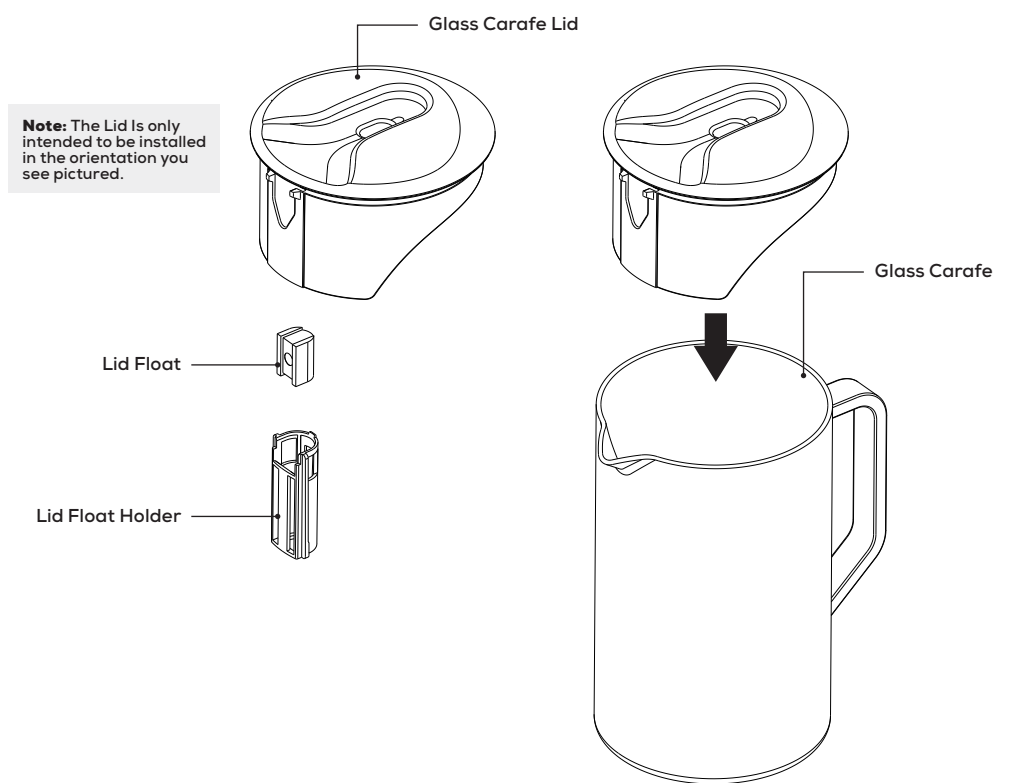

Water Filtration Process

4-Stage Reverse Osmosis Purification:

1.-2. Dual-Stage Pre/Carbon Filter & Carbon Filter (Capacity: 300 gal. or 6 months whichever comes first)

The Pre-Filter removes sand, silt, sediment, rust and particles from water. Activated carbon reduces chlorine taste and odors and then conditions the water before it is treated by the Reverse Osmosis membrane.

3. Reverse Osmosis (RO) Filter (Estimated Filter life of 24 months: Approximately 600 Gallons)

The RO Filter reduces impurities from the water down to 1/10,000 of a micron.

4. VOC Carbon Filter (Capacity: 300 gal. or 12 months) VOC Carbon with pH + Mineral Boost Filter (Capacity: 300 gal. or 12 months)

This Carbon Filter is made of high quality activated carbon. It is designed to remove volatile organic compounds (VOCs), enhance the taste and prepare the water for consumption.

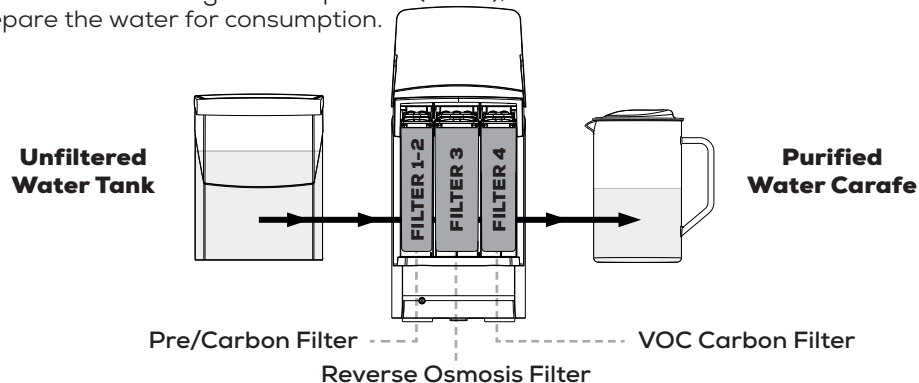

Installation

WARNING: Use and store AquaTru in a cool, shady place, away from direct sunlight. Do not keep your AquaTru in sunlight, since the bright light and heat facilitates algae growth.

CAUTION: Before installing the filters and cleaning the water tank, make sure that you have thoroughly cleaned your hands and your working surfaces are sanitized.

1. Remove all parts from the box.
2. Wash both the top water tank and glass carafe with soap and rinse before using the unit. (Figure 1)
3. Remove blue filter plug.
4. Remove the filters from vacuum-sealed bag.
5. Lift up on the filter lock and slide in the filter, making sure to align the filter with the filter channel in the AquaTru base. (Figure 2)
6. Push the filter all the way in. (Figure 3)

Figure 1

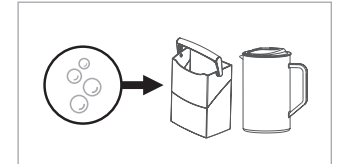

Figure 2

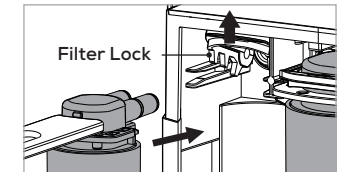
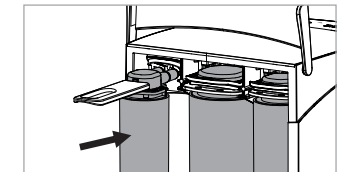

Figure 3



Installation instruction continues on next page. 

Installation

7. Push down on the filter lock until it snaps into place. (Figure 1)
8. Fill up the tap water tank with cold tap water and then reinstall the tank.
9. Insert the glass carafe, making sure the carafe lid is in the correct position. (Figure 2)
10. Plug in the unit.
11. The unit will start filtering water automatically.

Figure 1

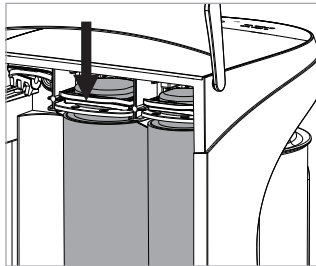
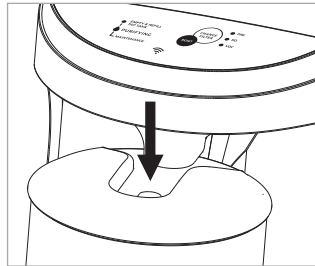

Figure 2



Note: It will take longer than normal for the first tank to go through a cycle as the filters become fully saturated. A white cloud will be visible in the tap water tank. This is perfectly normal, the white cloud contains tiny air bubbles released by the RO Filter.

First Time Start-Up Procedure

Run four full, unfiltered, tap water tanks through AquaTru before drinking.

Installation

NOTICE: Keep a close eye for any water leaks. In case of a leak, check the "Troubleshooting" guide on page 28.

12. AquaTru will stop filtering water when the clean water tank is full or when it is time to refill the tap water tank.

Note: When it is time to refill the tap water tank, it will be a quarter full. The leftover water is waste water with concentrated contaminants and MUST be emptied each time before refilling with tap water.

All RO water filtration systems will produce waste water when "back washing" the RO Filter. Most traditional RO systems have this dirty little secret. They waste up to five gallons of water to make just one gallon of pure water. With our patented AquaTru recirculation RO system, it only takes one gallon of tap water to make about 3/4 gallons of pure water. The water left in the tap water tank contains all the impurities from the tap water.

CAUTION! The water in the tap water tank must be discarded every time you refill the tap water tank. Failure to do so will cause excessive hardwater, void your warranty, and possibly damage the unit.

13. Empty and rinse both water tanks.
14. Repeat steps 8-13, three more times.
15. When four cycles have been completed, your new water purifier is ready for use.

Control Panel

When the unit is filtering water, the **Purifying** symbol will illuminate and pulsate.

The **Empty & Refill Tap Tank** will light up each time it is time to empty the tap tank and refill it. **You must always empty the tap tank before refilling it. Failure to do so will damage the unit and void the warranty.**

The Light on **Pre/Carbon Filter RO** (Reverse Osmosis Filter) and **VOC** (VOC Filter) will light up when it is time to replace the filter.

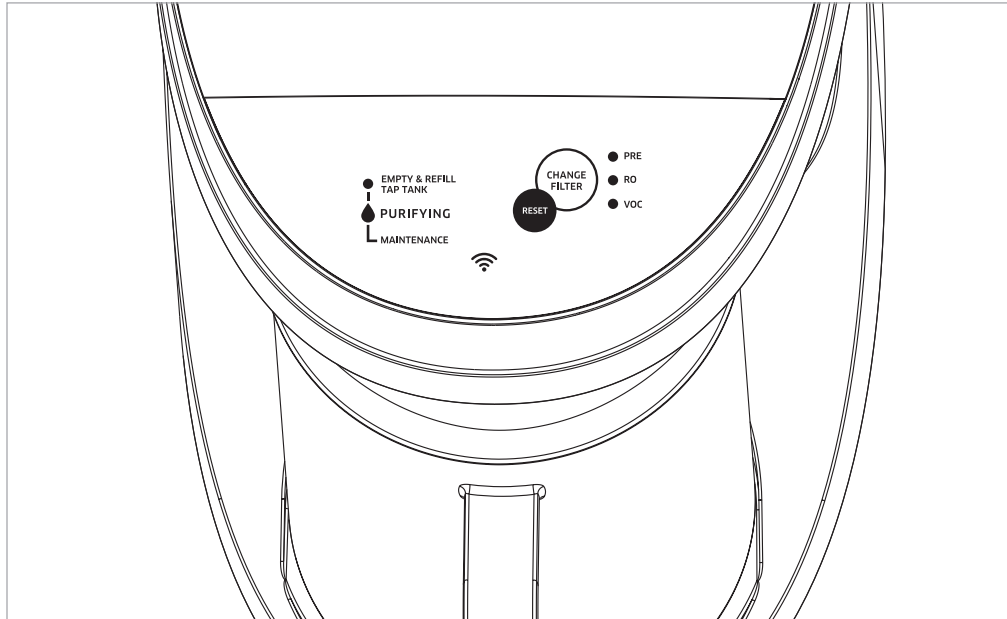

How To Use

USE ONLY COLD TAP WATER.

CAUTION: Before installing the filters and cleaning the water tank, make sure that you have thoroughly cleaned your hands and your working surfaces are sanitized.

1. Fill the tap water tank with cold water and install it on the AquaTru Carafe base.
2. Let the AquaTru filter the water until **PURIFYING** light stops and your front filtered water tank is full.
3. When it is time to refill the tap water tank, the **EMPTY & REFILL TAP TANK** will light up. **Each time the red EMPTY & REFILL light turns on be sure to empty all waste water from the tap water tank.** Refill the tap tank with cold water until it reaches just below the tank handle. Reinstall tank.
4. To dispense water, remove the glass carafe and pour the water. (Figure 1)
5. You may also buy an extra carafe to keep in the refrigerator to make cold water. (Figure 2)

Figure 1

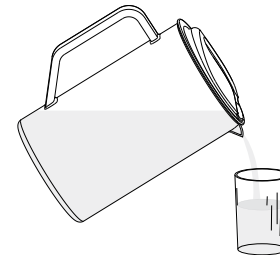
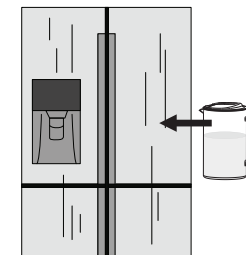

Figure 2



Note: For best performance and longevity, we recommend the AquaTru unit is always powered on with the Carafe installed to avoid frequent descaling of the unit.
EMPTY AND REFILL THE TAP WATER TANK EACH TIME THE LIGHT COMES ON.

Visit our website at AquaTru.com to order extra glass carafes, so you can double your water capacity.

Cleaning & Maintenance

Cleaning

Tanks – Clean both water tank and carafe, inside and out, with soap and water weekly.

Scale Deposits in Tap Water Tank

To remove white water scale deposits from your tap water tank, regularly clean it using dish soap and water. We recommend doing this cleaning on a weekly basis. For additional cleaning, soak the tank in warm water with AquaTru descaling powder for one hour, then scrub the inside of the tank. Use a soft, non-abrasive sponge to clean the tank's valves to ensure the removal of all calcium deposits. Always empty concentrated waste water from the tap water tank before refilling it in order to prevent buildup.

If you frequently have issues with scale deposits you need to follow the above directions closely. Always dump any waste water left in the tap water tank before refilling with fresh tap water. Failure to do so will cause damage to the unit and void your warranty.

Algae in the Water Tanks

In order to avoid algae from growing in the tap water tank and glass carafe, you need to wash them weekly and keep AquaTru away from heat sources and direct sunlight. In case of algae growth, we suggest that you soak the reservoirs in a bleach solution (follow the instructions on your bleach container to create a sanitizing solution) for one hour before washing with soap and water.

Unit/Base – Clean the outside of the unit using a non-abrasive sponge or towel with soap and water. To avoid water spots; use a clean drying towel to thoroughly dry all surfaces of the AquaTru.

Please Note: During normal use, small amounts of water may occasionally leak from tap tank valves. Use a dry towel to soak up any spillage before reinstalling tap tank.

Cleaning & Maintenance

AQUATRU CARAFE MAINTENANCE

WARNING: AquaTru Carafe has a built-in maintenance alert to let you know when your purifier needs some TLC. When the EMPTY & REFILL TAP TANK and PURIFYING lights turn on at the same time and the unit stops filtering water, this indicates Maintenance alert is on.



AquaTru Carafe is designed to complete filtering one full tank in about 12-15 minutes. If the time to filter one full tank exceeds 30 minutes, the unit will stop filtering, and the **EMPTY & REFILL TAP TANK** and **PURIFYING** lights will turn on simultaneously. When this happens, please follow the below maintenance steps to get your AquaTru Carafe back up and running.

There are 3 main reasons for the filtering time to be slower than usual and the Maintenance alert to activate:

- 1. High TDS or Total Dissolved Solids (AKA hard water) in the Tap Tank**
- 2. Scaling inside the RO Filter or internal parts of the purifier**
- 3. Valve malfunction**

We will go through what to do in each of these cases below.

How to Check if High TDS in the Tap Tank is Slowing Down the Filtering Time

Remove the Tap Tank from the unit to make sure it is clean and free of any hard water scale. If you see white hard water deposits inside the unit, descale the Tap Tank by using AquaTru Descaling Powder (Part #10AT01CADK06). Follow the directions on the

Cleaning & Maintenance

package. While cleaning the tap tank, make sure the tank's valves move freely and are free of any scale deposits. Fill the tap tank with cold tap water and place it on the base. Empty the clean water carafe and place it into position on the base. Measure the time it takes to filter one full tank.

If it takes about 30 minutes, you have hard water scaling inside the unit. See below section "How to remove Scaling inside the filters or unit."

If no water filters through the machine to the glass carafe, you may have a valve malfunction. Please contact customer support for assistance.

If filtering took about 15 to 20 minutes, you have high TDS (Total Dissolved Solids) water in the tap tank. To avoid this, always empty the tap tank of concentrated waste water produced after each cycle of purifying before refilling it with a full tank of fresh tap water.

How to Remove Scaling Inside the Filters or Units

Use the AquaTru Carafe Descaling Kit (Part# 90AT100DK01) available on the AquaTru website (aquatru.com) to descale the unit. Follow the instruction of the descaling kit to complete the full descaling process. After descaling is complete, filter one full tank and measure the time it takes to filter. If the time is over 20 minutes for 1 tank, we recommend replacing the RO Filter.

Valve Malfunction

If filtering time is still slow after checking for high TDS, descaling the unit, and replacing the RO Filter, please contact customer support for assistance.

Cleaning & Maintenance: Filters

Filter Replacement

AquaTru will track the usage of your filters and let you know when it's time for them to be changed. When a filter needs to be changed, the filter light will remain lit on either the Pre, RO, or VOC indicator. Upon replacement, press the filter **RESET** button on the control panel for **5 seconds** and the lights will turn off.

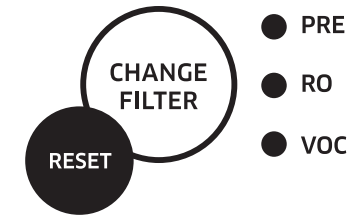

Note: Depending on the water quality where you live and your pattern of usage of the AquaTru, more frequent replacement of the RO Filter might be needed. If the filtering time of one tank takes longer than 30 minutes (normally it should take less than 15 minutes), we recommend replacing your RO Filter regardless of if the filter change light is on or not. If you change the filter prior to the indicator light turning on, please follow instructions about how to reset the filter on page 26.

Longer filtering time can occur if hard water scale builds up on the RO membrane and internal surfaces, which will slow and eventually block the water flow. If not addressed with proper maintenance, this will add extra stress to the pump and filter that can cause the machine to leak due to high-pressure and nowhere for the water to go, or lead to complete product failure. Please address excess filter time immediately by following appropriate descaling maintenance or replacement of an RO Filter. If you have any questions, please contact our customer support team.

Please visit our website to purchase replacement filters / aquatru.com

Cleaning & Maintenance: Filters

Filter Replacement

1. Remove the tap tank.
2. Push up on the filter lock to release it. (Figure 1)
3. Use the filter removal tool to pull out the old filter. (Figure 2)
4. Install new filter by aligning the filter guide and pushing the filter all the way in.
5. Lock the filter in place by pushing the filter lock down.
6. Press filter **Reset** button located on the control panel (Figure 3). Press and hold for at least 5 seconds.

Figure 1

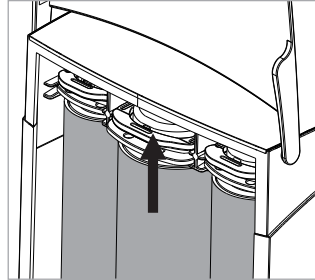

Figure 2

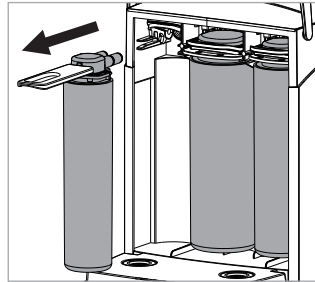
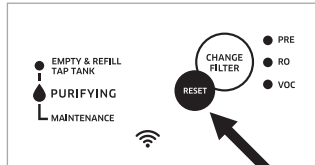

Figure 3



Cleaning & Maintenance: Filters

IMPORTANT: After installing a new filter, always discard the first two full water tanks the AquaTru produces.

If you replaced a pH+ Mineral Boost Filter, filter and discard the first four tanks.

IMPORTANT: Once you have installed the new filters, you must press the filter **Reset** button located on the control panel, located on the top of the unit. **If you do not do this step, the filter light indicator will stay lit and your AquaTru will not track the life of the new filter.**

Long Term Storage / Vacation

If leaving on vacation, start by unplugging the unit. Next, wash both the tap tank and glass carafe with soap and water. Allow them to dry thoroughly before reinstalling. When you have returned from vacation, purge the system of stagnant water by running four full tap water tanks through the system and discarding the water each time. Once the fourth tank has been filtered, the unit is ready to use. This process can be avoided by having a house sitter run one tank of tap water through the AquaTru at least once a week.

Cleaning & Maintenance: Filters

- Filter 1-2** | Pre/Carbon Filter (Part# 10AT100SF01)
- Filter 3** | Reverse Osmosis Filter (Part# 10AT100RF01)
- Filter 4** | VOC Carbon Filter (Part# 10AT100VF01) or
VOC Carbon Filter with pH + Mineral Boost (Part# 10AT100VFA01)

Early Filter Replacement before filter light has turned on

If you replace a filter before the filter change light turns on and you need to reset the filter timer, do the following:

- 1. Replace the filter:** Follow the steps in the manual.
- 2. Open the AQT app:** Open the device details for the desired unit. To view your device details, click on the purifier on the home screen. You should see the following (Figure 1).
- 3. Select the filter to be reset:** Click on the filter you would like to reset.
- 4. Reset the filter:** Click on "Reset the filter life to 100%" button. This should reset the filter life to 100%. See screen Figure 2 for reference.

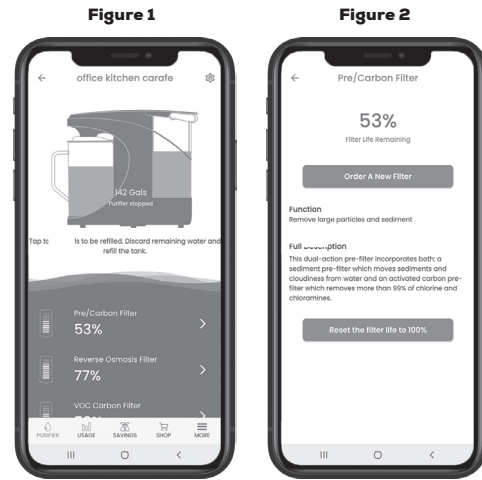

Cleaning & Maintenance: Nitrate/Nitrite Testing

All water filtration systems with RO filters certified to remove Nitrate/Nitrite must provide a way for the user to verify the performance of the RO filter. This is because, under certain use conditions, the efficiency of Nitrate/Nitrite removal rate can drop.





Scan code to learn more

aquatruwater.com/nitratetesting

Please scan the QR Code if you want to receive a free set of Nitrate/Nitrite Test Strips. These Test Strips will let you test the Nitrate and Nitrite Content of your AquaTru Purified water and ensure the water you drink is always the highest quality possible. We recommend testing every 6 months or when you change the Pre/Carbon Filter. If the Nitrate/Nitrite exceeds the safe levels indicated on the package, replace the RO filter to restore the performance.

Note that only Nitrite/Nitrate is affected by these use conditions; all other contamination tested under NSF 58 will maintain its efficiency even if Nitrate/Nitrite does not.

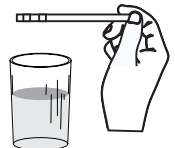
Instructions for Use

- 01**  Dip one test strip into filtered water for **2 seconds**
- 02**  Remove the test strip and let process for **30 seconds**
- 03**  Match the strip to the color chart strip's packaging

FAQ & Troubleshooting

CAUTION: Before doing any maintenance or troubleshooting, make sure that you have thoroughly cleaned your hands and your working surfaces are sanitized.

WARNING: To refill the tap water tank, ALWAYS remove the tank and discard the remaining water BEFORE refilling.

PROBLEM	REASON	SOLUTION
Unit will not power on.	Unit is not plugged in.	Plug power adapter into unit. Then plug the power cord into a GFCI equipped outlet.
	Lid is installed incorrectly.	Press down on tap tank and make sure glass carafe is correctly positioned to make sure it's fully inserted. The AquaTru Carafe uses a Magnetic Float on the lid to detect if the pitcher is installed and whether or not it's full. If the lid is installed incorrectly the unit will not filter.
Clean water carafe is empty but AquaTru will not start.	Tap water tank is empty.	Fill up the tap water tank.
	Tank or glass carafe is not fully in place or seated.	Reinstall both tank and carafe.
	You did not remove the tap water tank when you refilled it.	The tap water tank always has to be removed from the base and remaining water has to be discarded before refilling with tap water again. Failure to do so will void the warranty and the unit will stop filtering water.
	Water level floats may not be moving freely.	Check the water level float in each tank to make sure they can move freely up and down in the float holder.
Water tank or glass carafe smells.	The water tank or glass carafe is dirty.	Wash the water tank and glass carafe with soap and water once a week. Note: Use and store AquaTru in cool, shady place away from sunlight. Do not keep your Aquatru in sunlight, since sunlight and heat can facilitate algae growth.

FAQ & Troubleshooting

PROBLEM	REASON	SOLUTION
Tap water tank is leaking.	Tap tank is not properly seated.	Reinstall tank.
	The valve may not be closing properly.	To test valve, press the small black pins with spring located at the bottom of tap tank. Do this above a sink as water will release from the tank.
	You might have accumulated mineral scale on the valves.	Fill the tank with half vinegar half hot water solution from the faucet (do not use boiling water). Let it stand for 30 minutes. Drain by pushing on the valve under the tank. Wash thoroughly with soap and water before reinstalling back onto AquaTru.
AquaTru is filtering slower than usual.	The RO Filter might have come to the end of its life. As the RO Filter gets older, the filtering time may increase.	Depending on the water quality where you live and your pattern of usage of AquaTru, more frequent filter replacements may be needed. If the filtering time of one tank takes longer than 30 minutes (normally it should take 10- 15 minutes), we recommend you replace your RO Filter (filter #3) regardless of whether or not the filter change light is on or not.
	RO Filter may have become completely clogged.	Replace RO Filter (Part# 10AT100RF01). Very hard water can slow down the filtering time. Note: Longer filtering times do not impact the efficiency of the filters.
My clean water has higher TDS than before.	New VOC Carbon Filter has been installed.	Run four tap water tanks to rinse out particles from new Carbon Filter.
	RO Filter may need to be changed.	Generally, RO system lowers TDS readings by 90% as compared to tap water readings. If you see less than 80% reduction, you need to replace the RO Filter.

FAQ & Troubleshooting

PROBLEM	REASON	SOLUTION
AquaTru makes a strange noise.	Normal pump operation.	It is normal for the water pump to make noise while water is being filtered..
	New filter installation.	Some filters make extra noise as they become saturated. This is normal and should reduce in time.
Bad tasting water.	New filters have not been flushed completely.	Run four tanks of water through your AquaTru to rinse out particles when you install a new filter.
	Filter may need to be replaced.	Filters are old and need replacing. Order new filters at AquaTru.com.
	The water tanks are dirty.	Wash water tanks with soap and water once a week.
Water is leaking from the unit.	Filters installed incorrectly.	Reinstall each filter, making sure you hear a click. Make sure you are installing the filters in the correct spot. If the filter does not tightly and securely lock into place it is defective and needs to be replaced.
White cloudiness in the tap water tank.	Micro air bubbles from RO Filter.	This is normal and may be experienced during every use.
My tap water tank has white scaling.	The tank has accumulated minerals from the tap water.	The scaling can be removed using 1 packet of AquaTru's Descaling Powder (Part# 90AT100DK01). Fill the dirty tank with warm water and empty 1 packet of AquaTru Descaling Powder. Stir to dissolve, then let sit for one hour before scrubbing clean. Thoroughly rinse tank before reinstalling.

One-Year Limited Warranty

One-Year Limited Warranty

Your AquaTru water purifier is warranted to be free from defects in materials and workmanship for one year from the original purchase date. Should the product have a defect in materials or workmanship, we will repair or replace it without charge to you (a shipping and processing fee will apply). **Warranty does not include filters.** To obtain service under warranty, simply call our customer service center toll-free at **800.220.6570**.

This warranty does not cover filters, damage caused by accident, misuse or any use other than as intended and described in this product manual, or damage resulting from failure to maintain and clean this product as also specified in this product manual. This warranty applies only to the original purchaser of the AquaTru water purifier.

ALL EXPRESS AND IMPLIED WARRANTIES FOR THIS PRODUCT, INCLUDING IMPLIED WARRANTIES OF MERCHANTABILITY AND FITNESS FOR A PARTICULAR PURPOSE, ARE LIMITED IN DURATION TO THE WARRANTY PERIOD, AND NO WARRANTIES, WHETHER EXPRESS OR IMPLIED, WILL APPLY AFTER THIS PERIOD.

Some states do not allow limitations on the duration of implied warranties, so the above limitation may not apply to you. While this warranty gives you specific legal rights, you may also have other rights which may vary from state to state.

Contact Info for Warranty Service:

AquaTru® LLC

P.O. Box 9169 | Van Nuys, CA | 91409-8291
1.800.220.6570 | AquaTru.com

©2024 AquaTru® LLC.
All Rights Reserved.

Arbitration Agreement

PLEASE READ THIS AGREEMENT CAREFULLY. YOU ACCEPT THE TERMS OF THIS AGREEMENT BY RETAINING THE PRODUCT(S) SHIPPED IN CONNECTION WITH THIS AGREEMENT (THE "PRODUCTS") FOR MORE THAN THIRTY (30) DAYS AFTER RECEIPT. IF YOU DO NOT AGREE TO THE TERMS OF THIS AGREEMENT, YOU MAY RETURN THE PRODUCT TO COMPANY WITHIN THIRTY (30) DAYS OF RECEIPT FOR A FULL REFUND.

THIS ARBITRATION AGREEMENT ("AGREEMENT") AFFECTS YOUR LEGAL RIGHTS AND REMEDIES BY PROVIDING THAT DISPUTES BETWEEN YOU AND THE MANUFACTURER, DISTRIBUTOR AND/OR SELLER OF THIS PRODUCT (COLLECTIVELY, "COMPANY"), MUST BE RESOLVED THROUGH BINDING ARBITRATION AND NOT IN COURT. IT ALSO PROVIDES THAT ANY DISPUTE CANNOT BE RESOLVED IN A CLASS ACTION OR OTHER PROCEEDING WHERE YOU REPRESENT OTHER PERSONS OR OTHER PERSONS REPRESENT YOU, AND THAT NO CLASS OR REPRESENTATIVE ARBITRATIONS ARE PERMITTED. PLEASE CAREFULLY READ ALL TERMS IN THIS AGREEMENT.

1. RESOLUTION OF CLAIMS OR DISPUTES.

Any claim or dispute between you and Company (or any of Company's subsidiaries or affiliates) arising out of or relating in any way to the Product or this Agreement shall be resolved through final, binding arbitration. This arbitration obligation is reciprocally binding on both you and the Company and applies regardless of whether the claim or dispute involves a tort, fraud, misrepresentation, product liability, negligence, violation of a statute, or any other legal theory. Both you and Company specifically acknowledge and agree that you waive your right to bring a lawsuit based on such claims or disputes and to have such lawsuit resolved by a judge or jury.

2. LIMITATION OF LEGAL REMEDIES.

All arbitrations under this Agreement shall be conducted on an individual (and not a class-wide) basis, and an arbitrator shall have no authority to award class-wide relief. You acknowledge and agree that this Agreement specifically prohibits you and the Company from commencing arbitration proceedings as a representative of others or joining in any arbitration proceedings brought by any other person. The parties agree that no class or representative actions of any type are permitted.

3. ARBITRATION PROCEDURES.

- a.** Before instituting an arbitration, if you have any dispute, we strongly encourage you to contact the Company to try to resolve the matter by calling 800.218.3560, although you are not required to do so.
- b.** The arbitration of any claim or dispute under this Agreement shall be conducted in accordance with the expedited procedures set forth in the JAMS Comprehensive Arbitration Rules and Procedures

Arbitration Agreement

as those Rules exist on the date you receive the Product, including Rules 16.1 and 16.2 of those Rules. These rules and procedures are available by calling JAMS or by visiting its web site at www.jamsadr.com. The arbitration of any claim or dispute under this Agreement shall be conducted by an arbitrator who has at least five years of experience conducting arbitrations.

- c.** The arbitration of any claim or dispute under this Agreement shall be conducted in the State of California or the location in which you received this Agreement. For claims of \$10,000 or less, you may choose whether the arbitration proceeds in person, by telephone, or based only on submissions.
- d.** The Company shall pay costs for the arbitration of claims, including any JAMS Case Management Fee and all professional fees for the arbitrator's services. The Company shall pay the fees and costs of its own counsel, experts and witnesses and shall not be able to recoup them from you even if you do not prevail in the arbitration. Unless otherwise provided by law, you acknowledge and agree that you shall pay the fees and costs of your own counsel, experts and witnesses.

4. CHOICE OF LAW.

The arbitration provisions of this Agreement and any arbitration conducted pursuant to the terms of this Agreement shall be governed by the Federal Arbitration Act (9 U.S.C. Secs. 1-16). In this respect, the parties acknowledge that this Agreement involves a transaction conducted in interstate commerce. Otherwise, this Agreement and the rights of the parties hereunder shall be governed by and construed in accordance with the laws of the State of California, exclusive of conflict or choice of law rules.

5. SEVERABILITY.

If any provision of this Agreement is declared or found to be unlawful, unenforceable or void, such provision will be ineffective only to the extent that it is found unlawful, unenforceable or void, and the remainder of the provision and all other provisions shall remain fully enforceable.

Acuerdo de Arbitraje

LEA ATENTAMENTE ESTE ACUERDO. USTED ACEPTA LOS TÉRMINOS DE ESTE ACUERDO AL CONSERVAR EL PRODUCTO (LOS PRODUCTOS) ENVIADOS BAJO A ESTE ACUERDO (LOS "PRODUCTOS") POR MÁS DE TREINTA (30) DÍAS DESPUÉS DE SU RECEPCIÓN. SI NO ESTÁ DE ACUERDO CON LOS TÉRMINOS DE ESTE ACUERDO, PUEDE DEVOLVER EL PRODUCTO A LA EMPRESA EN UN PLAZO DE TREINTA (30) DÍAS A PARTIR DE HABERLO RECIBIDO PARA OBTENER UN REEMBOLSO COMPLETO.

TESTE ACUERDO DE ARBITRAJE ("ACUERDO") AFECTA A SUS DERECHOS Y RECURSOS LEGALES AL ESTABLECER QUE LAS DISPUTAS ENTRE USTED Y EL FABRICANTE, DISTRIBUIDOR Y/O VENDEDOR DE ESTE PRODUCTO (COLECTIVAMENTE, "COMPAÑÍA"), DEBEN RESOLVERSE MEDIANTE ARBITRAJE VINCULANTE Y NO EN LOS TRIBUNALES. TAMBIÉN ESTABLECE QUE CUALQUIER DISPUTA NO PUEDE SER RESUELTA EN UNA ACCIÓN COLECTIVA U OTRO PROCEDIMIENTO EN EL QUE USTED REPRESENTA A OTRAS PERSONAS O QUE OTRAS PERSONAS LE REPRESENTEN A USTED, Y QUE NO SE PERMITEN ARBITRAJES COLECTIVOS O REPRESENTATIVOS. POR FAVOR LEA DETENIDAMENTE TODOS LOS TÉRMINOS DE ESTE ACUERDO.

1. RESOLUCIÓN DE RECLAMACIONES O DISPUTAS.

Cualquier reclamación o disputa entre usted y la Compañía (o cualquiera de las subsidiarias o filiales de la Compañía) que surja o esté relacionada de alguna manera con el Producto o este Acuerdo se resolverá mediante un arbitraje final y vinculante. Esta obligación de arbitraje es recíprocamente vinculante tanto para usted como para la Compañía y se aplica independientemente de si la reclamación o disputa implica un agravio, fraude, tergiversación, responsabilidad por el producto, negligencia, violación de una ley o cualquier otra teoría legal. Tanto usted como la Compañía reconocen y aceptan específicamente que renuncian a su derecho a presentar una demanda judicial basada en dichas reclamaciones o disputas y a que dicha demanda sea resuelta por un juez o un jurado.

2. LIMITACIÓN DE LOS RECURSOS LEGALES.

Todos los arbitrajes en virtud del presente Acuerdo se llevarán a cabo de forma individual (y no colectiva), y un árbitro no tendrá autoridad para conceder una reparación colectiva. Usted reconoce y acepta que este Acuerdo le prohíbe específicamente a usted y a la Compañía iniciar procedimientos de arbitraje como representante de otros o unirse a cualquier procedimiento de arbitraje presentado por cualquier otra persona. Las partes acuerdan que no se permiten acciones colectivas o representativas de ningún tipo.

Acuerdo de Arbitraje

3. PROCEDIMIENTOS DE ARBITRAJE.

- a. Antes de iniciar un arbitraje, si tiene alguna disputa le recomendamos encarecidamente que se ponga en contacto con la Compañía para intentar resolver el asunto llamando al 800.218.3560, aunque no está obligado a hacerlo.
- b. El arbitraje de cualquier reclamación o disputa en virtud de este Acuerdo se llevará a cabo de acuerdo con los procedimientos acelerados establecidos en las Normas y Procedimientos de Arbitraje Integrales de JAMS, tal y como existían en la fecha en que usted recibió el Producto, incluidas las Normas 16.1 y 16.2 de dichas Normas. Estas normas y procedimientos están disponibles llamando a JAMS o visitando su sitio web en www.jamsadr.com. El arbitraje de cualquier reclamación o disputa en virtud de este Acuerdo será llevado a cabo por un árbitro que tenga al menos cinco años de experiencia en la realización de arbitrajes.
- c. El arbitraje de cualquier reclamación o disputa en virtud de este Acuerdo se llevará a cabo en el Estado de California o en el lugar en el que usted recibió este Acuerdo. En el caso de reclamaciones de \$10,000 o menos, usted podrá elegir si el arbitraje se lleva a cabo en persona, por teléfono o únicamente basado en la presentación de documentación.
- d. La Compañía pagará los costes del arbitraje de las reclamaciones, incluyendo cualquier tasa de gestión de casos de JAMS y todos los honorarios profesionales por los servicios del árbitro. La Compañía pagará los honorarios y costes de sus propios abogados, peritos y testigos y no podrá recuperarlos de usted aunque no prevalezca en el arbitraje. A menos que la ley disponga lo contrario, usted reconoce y acepta que pagará los honorarios y costes de su propio abogado, peritos y testigos.

4. ELECCIÓN DE LA LEY.

Las disposiciones de arbitraje de este Acuerdo y cualquier arbitraje llevado a cabo de conformidad con los términos de este Acuerdo se regirán por la Ley Federal de Arbitraje (9 U.S.C. Artículos 1-16). A este respecto, las partes reconocen que este Acuerdo implica una transacción realizada en el comercio interestatal. Por lo demás, el presente Acuerdo y los derechos de las partes en virtud del mismo se regirán e interpretarán de acuerdo con las leyes del Estado de California, excluyendo las normas de conflicto o elección de la ley.

5. DISPOSICIONES INDEPENDIENTES.

Si alguna de las disposiciones del presente Acuerdo se declara o se considera ilegal, inaplicable o nula, dicha disposición será ineficaz sólo en la medida en que se considere ilegal, inaplicable o nula, y el resto de las disposiciones y todas las demás cláusulas seguirán siendo aplicables plenamente.

Transform Water, Transform Lives

We believe good health starts with clean, pure water. That's why we're passionate about delivering best-in-class water purifiers wherever people drink water. We're committed to caring for our environment by reducing single-use plastic bottles.

Let's create waves of impact together!
Visit the link or scan the QR code below to see the stories and communities you're supporting.

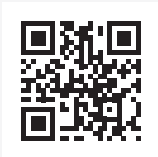

Scan code to learn more
aquatru.com/impact

Show us how you AquaTru!

Tag and follow us @aquatru
#TRUwaterwarriors



AQUATru® 
carafe smart

