



20"/26" CAGED

Ceiling Fan with Light

User Manual

GET MORE SUPPORT

If you experience any issues while operating our products, please directly reach out to our Customer Support via Amazon Orders. Or you can send your inquiry to our Official Customer Support at:

This fixture comes without a light bulb

 support@depuley.com

 (001)201-365-0018

WS-FPZ57
WS-FPZ58

please scan the QR code to
watch the installation video.





WARNING

It is prohibited to run the motor without a load. Powering on the motor for testing when the fan blades are not installed or the assembly is incomplete may lead to motor overheating, bearing damage, or circuit failures (the motor of the ceiling fan light is equipped with a built-in sensor that will automatically stop the operation when it is running without a load).

It is recommended to complete all the assembly work according to the installation guide before powering on to avoid damaging the motor.



Thank you for choosing us.
We are here to support you every step of the way.

Active **20%** off
discount
in next purchase

“Order ID”



support@depuley.com

Contact US

01

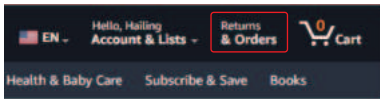

Log into your Amazon.com account,click
“Returns&Others” on the top-right corner.

02

ORDER # 111-1111111-1111111

[View order details](#)

Find your order in the list and click “View order details”

03

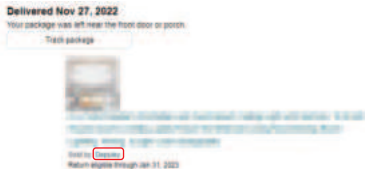

Click the“Store Name”following the Sold by,below the
product title.

04

Have a question for BvenuBigLite Ceiling Fan?

[Ask a question](#)

Click the button “Ask a question”,on the top-right
corner,to contact the seller.



WARNING

To avoid fire, shock, and serious personal injury, please read the following instructions carefully. Important Safety instructions.

- Before installing the fan, disconnect the power by removing fuses or turning off circuit breakers.
- Make sure the installation site you choose allows a minimum clearance of 7 feet from the blades to the floor and at least 30 inches from the tip of the blades to any obstruction (see the picture at the last page).
- If you are mounting the fan on a ceiling outlet box, use a metal sturdy base. Secure the box directly to the building structure. The outlet box and its support must be able to support the moving weight of the fan at least 45 pounds. Do not use a plastic outlet box. Attach the mounting brackets by winding the hardware provided with the can to the ceiling outlet box.
- If you are mounting the fan to a joist, make sure it is strong enough to support the moving weight of the fan (at least 45 pounds).
- After installing the fan, make sure all the connections are secured. This will prevent the fan from falling.
- Do not insert anything into the fan blades while the fan is operating.
- Turn the fan off and wait for it to stop before reversing fan direction.
- To reduce risk of electrical shock and personal injury, do not install the fan on a sloped ceiling.
- To reduce the risk of electrical shock and personal injury, do not use this fan with any solid-state.
- To reduce risk of personal injury, use only the two steel screws and lock washers provided with the fan for mounting the outlet box.

RISK OF ELECTRIC SHOCK

- Before you start installing this ceiling fan, disconnect the power supply by turning off the circuit breaker.
- All electrical connections must be in accordance with local standard National Electrical Code (NEC) and ANSI/NFPA 70.
- Consult a qualified electrician if you are unfamiliar with proper electrical wiring connections.
- Do not alter, re-locate, or remove wiring when nothing goes wrong with the product.
- Double-check all connections and screws to be sure they are tight and correct.
- Verify whether the supply voltage is correct by comparing it with the product information.

RISK OF INJURY

- Keep all the parts of this product away from children. The package contains many small or heavy parts that may bring children the risk of injury.
- Make sure to install all parts firmly enough in case they fall while running. Carefully check all screws, bolts, and washers on the fan assembly to ensure they are secured.
- Wear safety gloves and safety glasses always when installing or removing the light or the fan, or performing maintenance. Some parts of the components are sharp and may hurt your hands; please make sure you are wearing safety gloves when touching and installing the components.
- Wear rubber-soled shoes and work on a sturdy ladder.

MAINTENANCE TIPS:

- Periodically cleaning your ceiling fan is the only required maintenance. When a soft brush or lint-free cloth to avoid scratching the paint, please turn off the electrical power before you clean your fan.
- Do not use water when cleaning your ceiling fan. It could damage the motor or the blades or even cause an electrical shock.
- The motor has permanently lubricated ball bearings. No need to oil.

MAKE SURE THE POWER IS OFF IN THE ELECTRICAL PANEL BOX BEFORE YOU DO ANY CLEANING OR REPAIRS.



WARNING

To avoid serious injury or death, turn off the power at the circuit breaker before installing the fan.



TURN OFF

IMPORTANT

To avoid abnormal operation, do not connect the product to the dimmer switch or fan speed switch.



Applicable to only one type of ceiling



Downrod Mount



Sloped Ceiling Mount



Installation distance reference

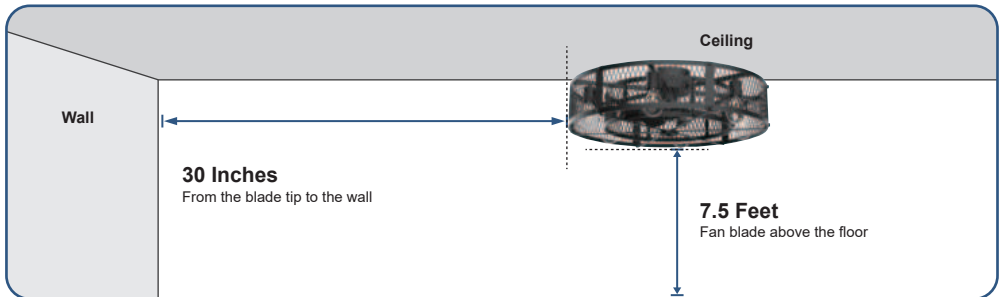

TOOLS NEEDED



Phillips Screwdriver



Wire Stripper



Step Ladder



Safety Gloves



If you have trouble reading the instructions,
please scan the QR code to watch the installation video.



01



02



03

Need a Video instruction Guide?
Please scan the QR code

**If the QR code is invalid, please contact us
for the video.**

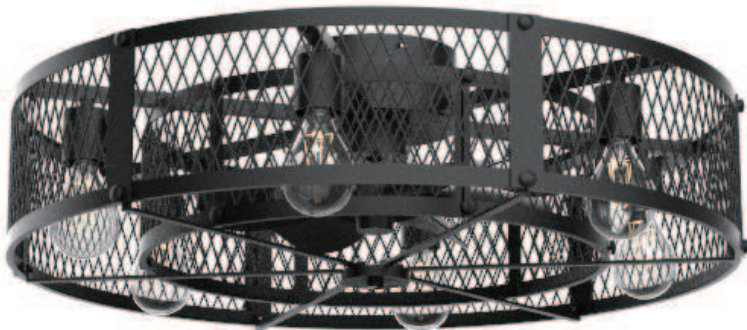



Remote Control

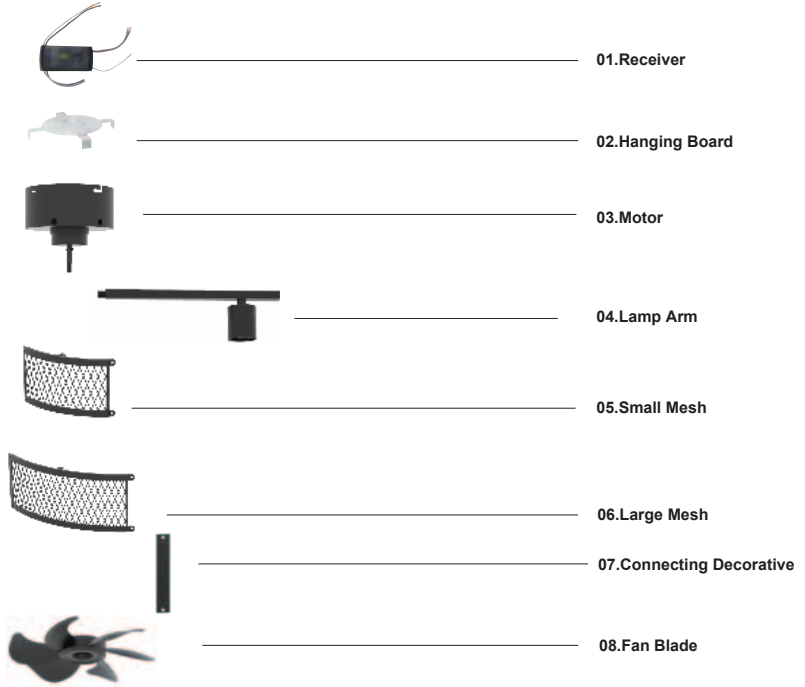

01 x1



02 x1



03 x1



04 x6



05 x6

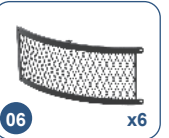

06 x6



07 x6



08 x1



09 x42

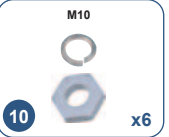

10 x6



11 x4

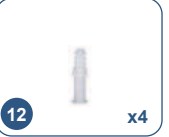

12 x4

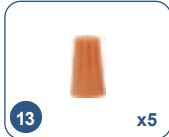

13 x5



14 x1



15 x12

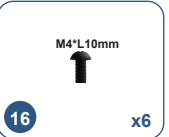

16 x6

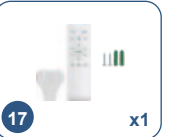

17 x1



18 x2



19 x24



20 x6

Notice : The quantity listed above is the number required for installation. If there is a missing part in your package, please reach out to us support@depuley.com.



20" Fan Light Accessories List

26" Fan Light Accessories List on the previous page



Remote Control

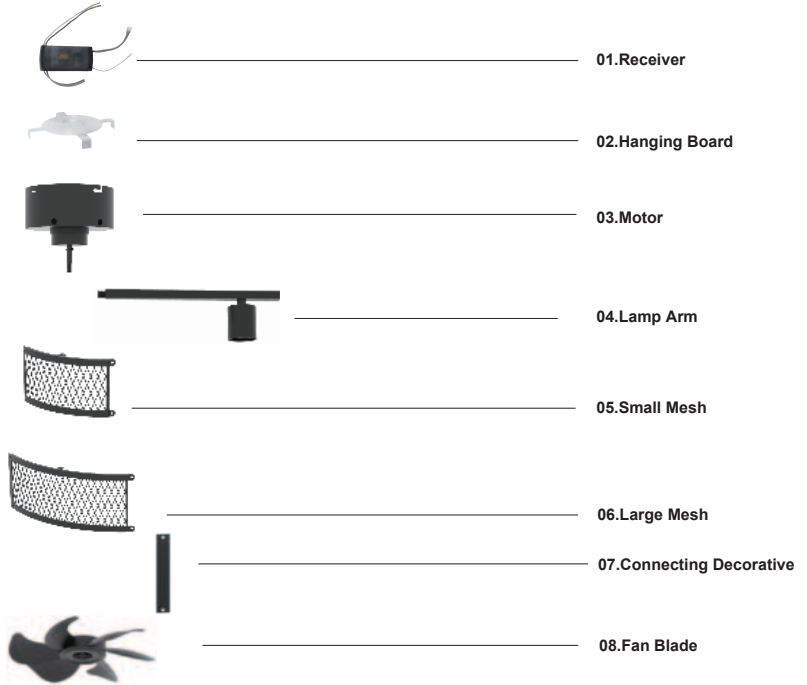

01

x1



02

x1



03

x1



04

x4



05

x4

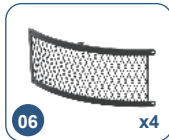

06

x4



07

x4



08

x1



M4

09

x28

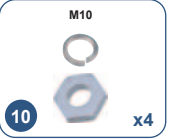

M10

10

x4



11

x4



12

x4



13

x5



14

x1

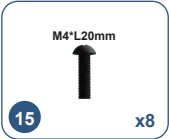

M4*L20mm

15

x8

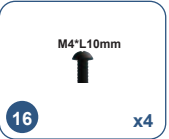

M4*L10mm

16

x4

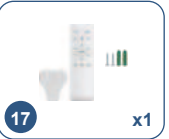

17

x1

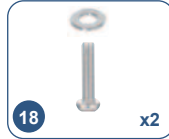

18

x2



19

x16



20

x4

Notice : The quantity listed above is the number required for installation. If there is a missing part in your package, please reach out to us support@depuley.com.



01



Customers who have purchased a 20 inch fan light, please note that this manual provides installation instructions for a 26 inch fan light. However, the installation method of a 20 inch fan light is exactly the same as that of a 26 inch fan light, with only differences in the number of accessories and size.

20 inch fan light display

02



Section 1

Hanging Board



Difficulty Level: ★☆☆☆☆

Let's move towards success with a relaxed start !

Needed Accessories

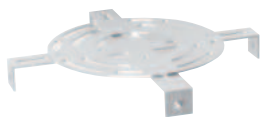

x1



x4





Installation Steps

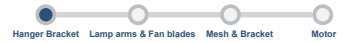

! The ceiling fan must be installed in the location where there is 12"(300mm) spacing from the tips of all blades to the nearest objects or walls. **REMEMBER** to turn off the power before hanging the fan. Follow the instruction below to hang your fan properly:

1

Thread the wires in the junction box through the Mounting Bracket. Fasten the hanger to the junction box using #8-32 Mounting Bolts(x2) and Spring Washers(x2), Flat Washers(x2)

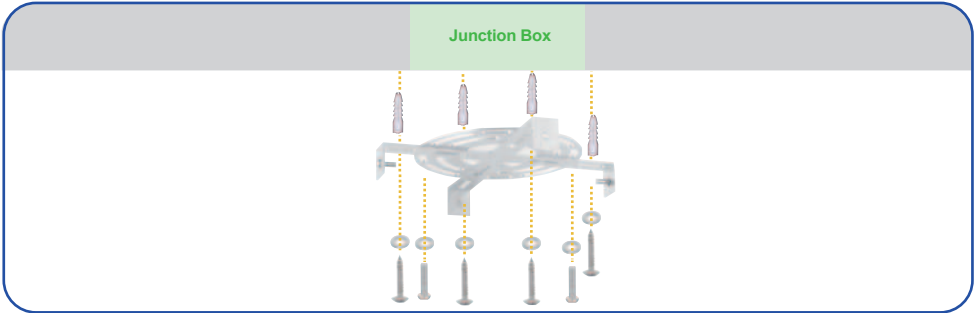

2

For wood ceiling, secure the mounting bracket to the ceiling that is capable of carrying a load of at least 100lbs (45kgs) with four long mounting screws and washers provided. Be sure at least #10-12(38mm) of the screw is threaded into the support.

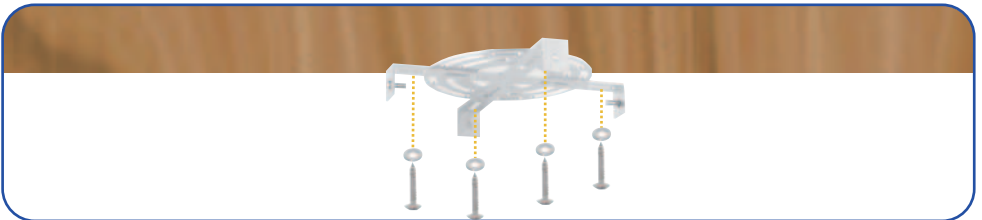

Section 2

Lamp arms & Fan blades



Difficulty Level: ★★☆☆☆

There will be some wiring involved, but don't worry, I'm sure you can do it !

Needed Accessories



x1



x6



x6



x1





Installation Steps

01



02

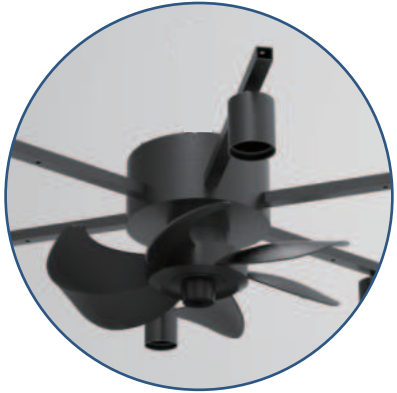



Installation Steps

Hanger Bracket Lamp arms & Fan blades Mesh & Bracket Motor

03



Section 3

Mesh & Bracket



Difficulty Level: ★ ★ ★ ★ ☆

You are almost finished! Let there be light!

Needed Accessories

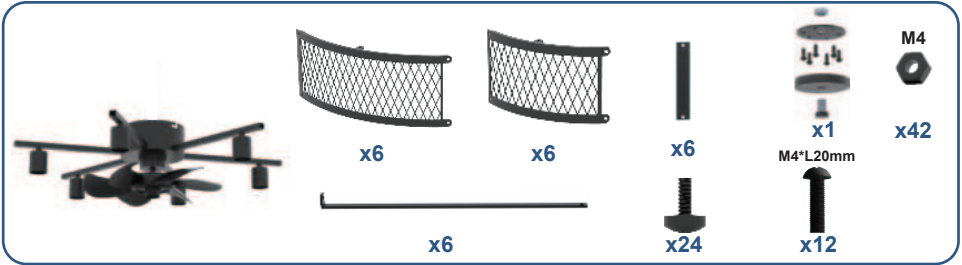



Installation Steps

01

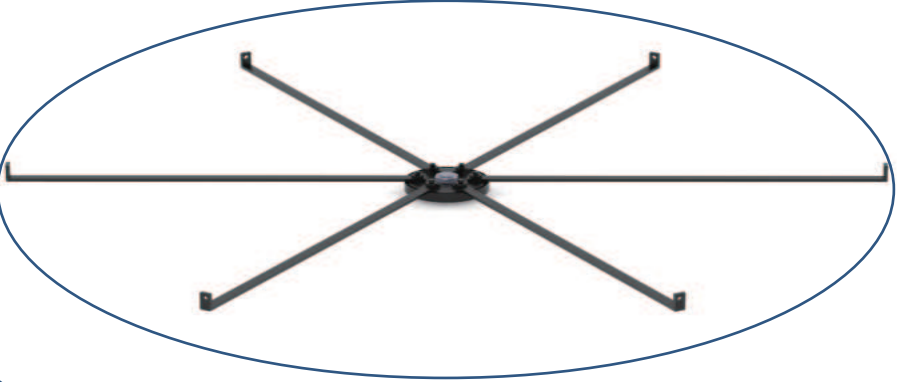
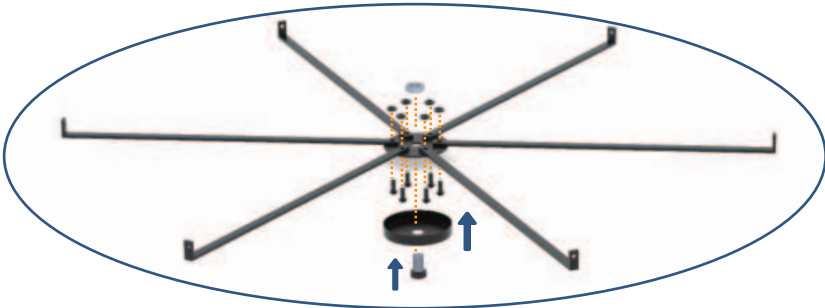

02

Please note that the installation here is a small mesh, not a large mesh.

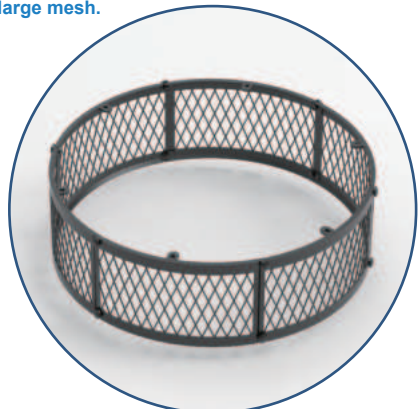
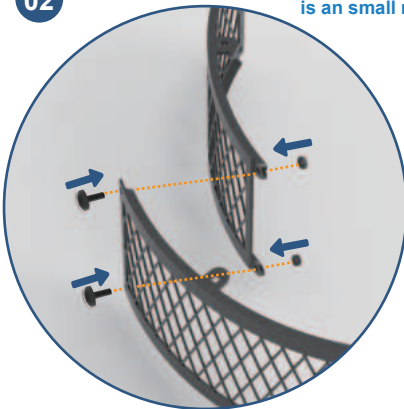



Installation Steps

03

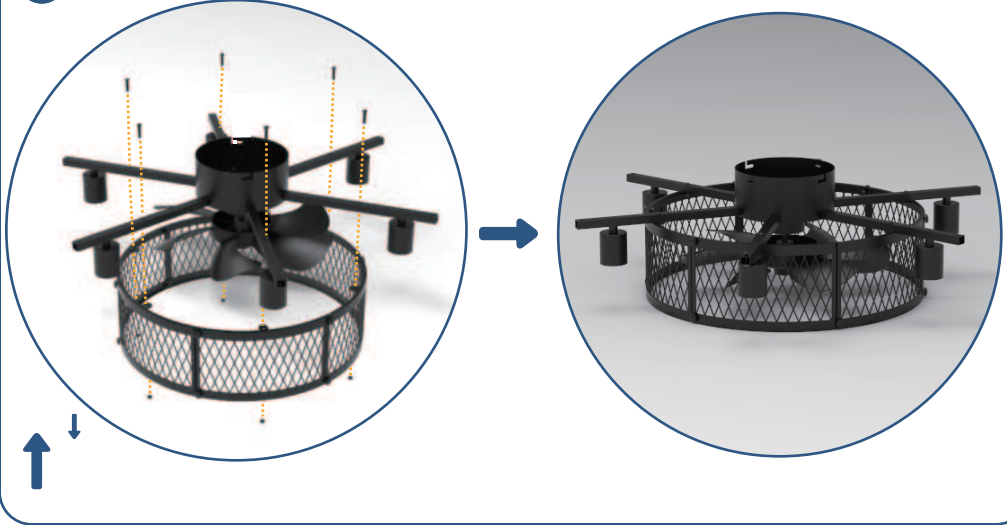

04

Please note that this is the installation of a large mesh. First, lock the holes on the top, and do not lock the holes on the bottom, as shown in the picture on the upper right. The area with small circular discs is above the large mesh, please pay attention to observe to avoid disturbing the direction.

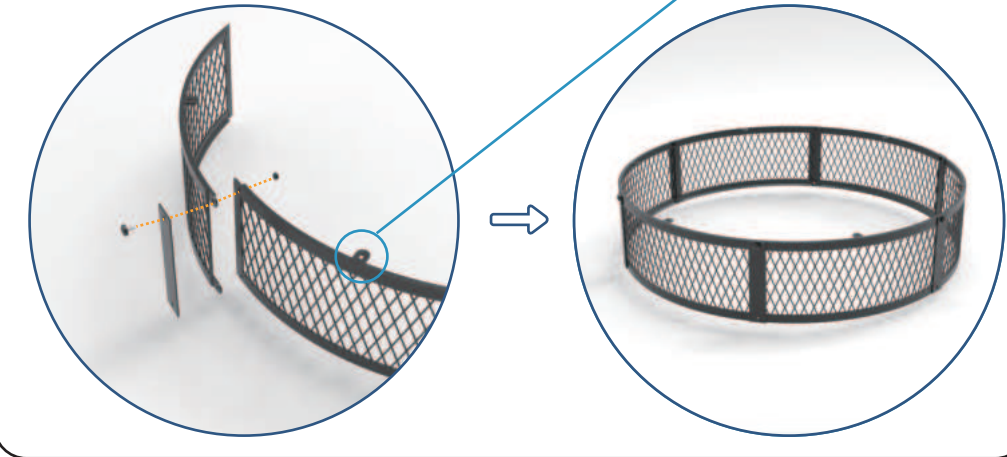



Installation Steps

05

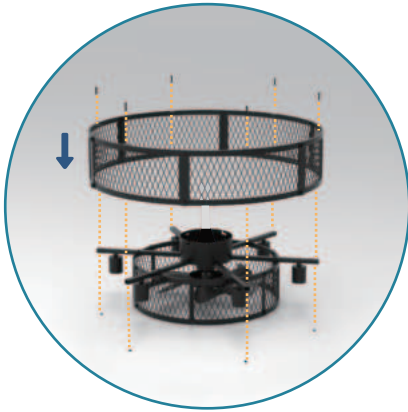

06

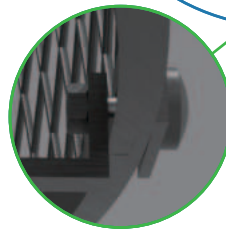
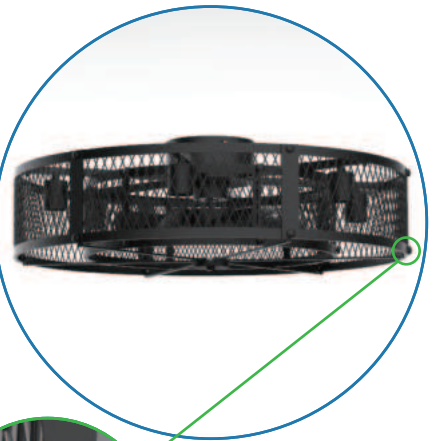

Section 4 Downrod



Difficulty Level: ★★☆☆☆

You are almost finished! Let there be light!

Needed Accessories

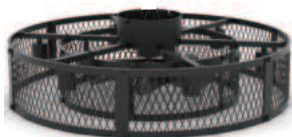

x5



x1

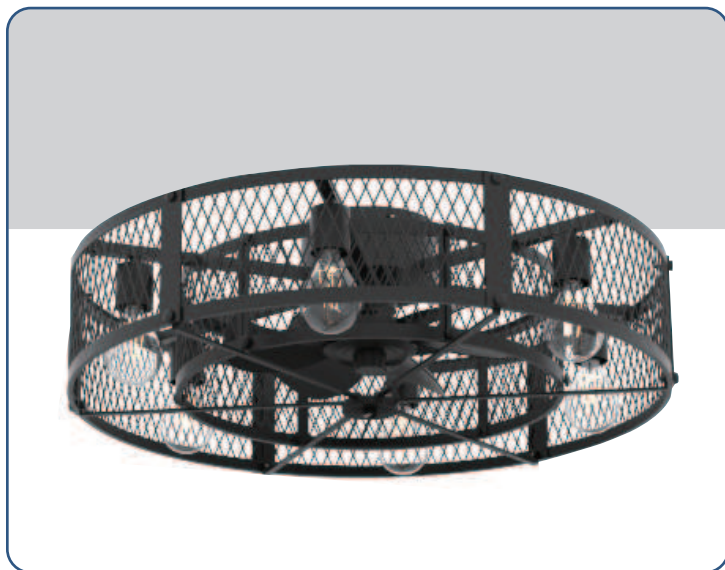



Installation Steps

Hanger Bracket Lamp arms & Fan blades Mesh & Bracket **Motor**

01

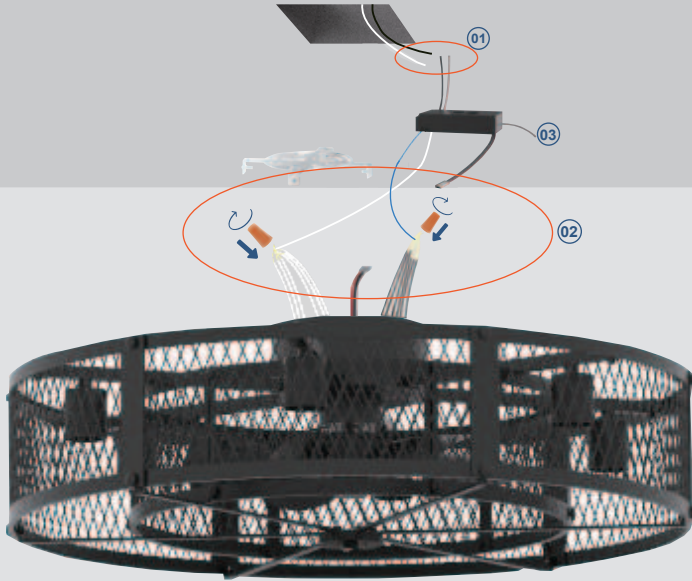

01

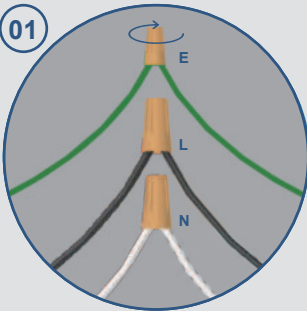

02

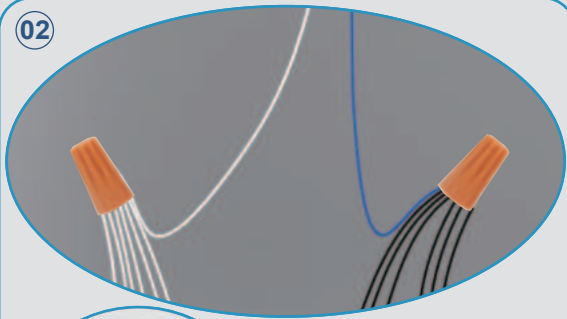

03

Make sure the antenna is not squeezed

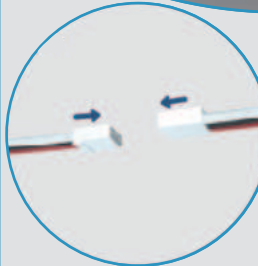
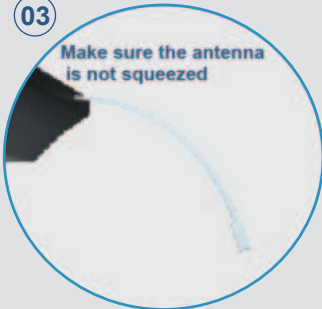

This step is to connect the two black, red, and white wire terminals, as well as connect all the black wires of the lamp arm and the blue wires of the receiver with wiring caps, and then connect all the white wires of the lamp arm and the white wires of the receiver.



Installation Steps

Hanger Bracket Lamp arms & Fan blades Mesh & Bracket **Motor**

02

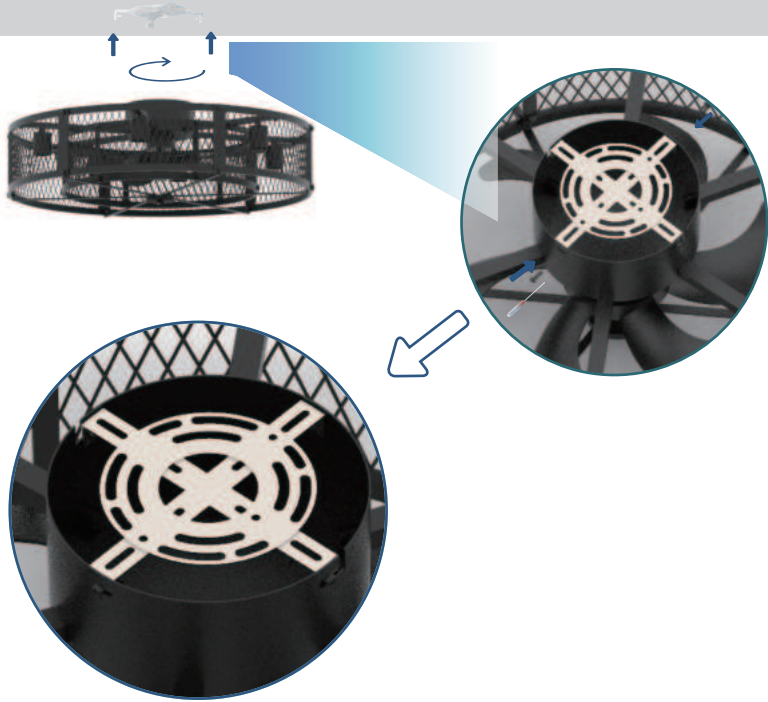

(Please note that this product does not include a bulb)
Good! You've finished the hardest part!



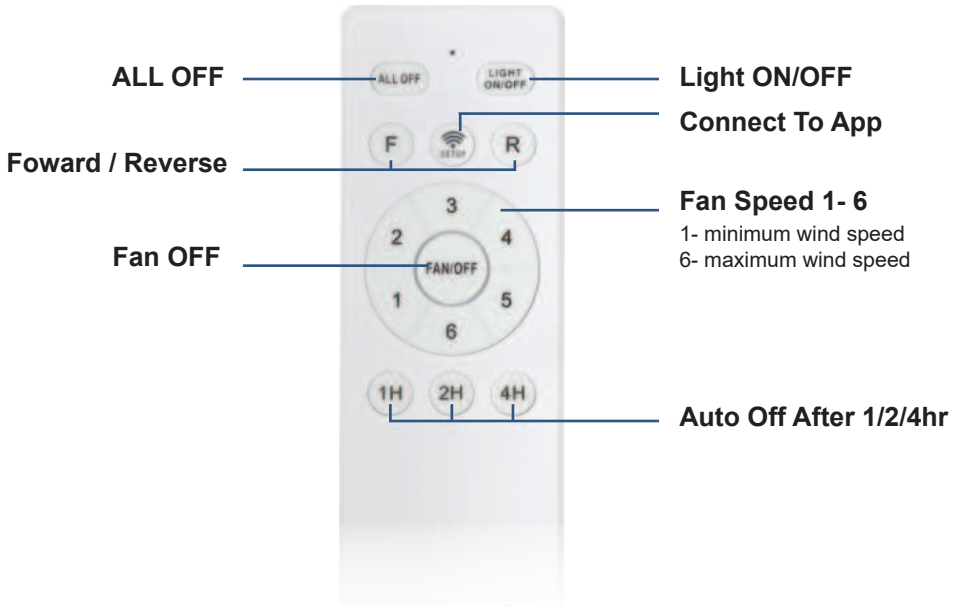

Remote Control

Points For Attention



- **Install 1.5*2 volt battery**(not included)
(To prevent damage to transmitter, remove the battery if not used for a long time)
- **Do not place the remote control in an excessively hot or humid environment**
- **Remote control learning code method:**
Your remote control and ceiling fan light have been successfully paired initially. If you find that the remote isn't working properly during use, you can re-pair them by following these steps:

Step 1: Turn off the wall control switch.

Step 2: Turn on the wall control switch, within 3 seconds of the fan light lighting, press and hold the "**SETUP**" for 3 seconds until you see the fan light flash once. This indicates that the pairing process has been successfully completed.



Scan the QR code to download the remote control app.

App Control

Points For Attention



- **Connecting with mobile phone APP**
Scan the QR code to download the "Smart Home Light" APP.
- Make sure that your Bluetooth are enable when using the Smart Home Light.
- **Bluetooth connection**
Power off the receiver for 5 seconds Turn on the power and immediately press the key of  for 1 second then learn successfully.



Your fan may occasionally jerk forward or backward upon starting up, This is normal and does not affect the fan operation, Try these troubleshooting steps before contacting customer service.

Problem ▶	Solution
Fan not spinning	<p>Make sure the fan is getting power. Check your circuit breaker or fuse panel and wall switch for functionality. Check to make sure the fan wires are correctly connected to the house wires. Remote control must be paired with the fan within 1 minute after connecting the fan to the electrical. Use a multimeter and test the adapter wiring harness to see if there is any electrical output. All the pin wiring on the circuit board must be inserted tight and in the correct position. Make sure the fan blades spin freely. If you're using a wall control, check the power to the breaker from your control and try working your ceiling fan manually. (Normal switch only for the fan power on/off)</p>
Fan light not working	<p>Make sure LED wires are connected to the circuit board. Make sure the whole fan is powered.</p>
The fan is noisy and wobbling	<p>Check if the blade screws are NOT rubbing against any part of motor housing. Check the pin wires are NOT connected against any moving parts. Check the down fan cup is NOT hitting the motor. Confirm the canopy is NOT touching the ceiling while the fan is in operation. Check the down rod is NOT slanted. Tighten any loose screws on the light kit, fan blades, motor coupling, down rod, brackets and mounting hardware. Confirm the hanger ball is firmly seated in the mounting bracket. The ceiling beam must meet the minimum tensile test strength of 30KG for installation. Verify the wire connections are not rattling against each other. Verify the fan blades are not cracked, if the fan blades are cracked, replace the damaged blades with a new blade set from the same brand as your ceiling fan to ensure compatibility Confirm the light kit is NOT slanting and hitting the motor.</p>
The fan or light automatically turns on/off	<p>Confirm the circuit breaker is not malfunctioning. Verify the wire connections are not frayed. Check the app is not set to a timer or schedule. Cut the fan power for 10 minutes then power on again. All the pin wiring on the circuit board must be inserted tight and correct position.</p>



Note:

English

1. The lamps may only be installed by authorized and qualified technicians according to the valid regulations for electrical installation.
2. The manufacturer does not accept any responsibility for injuries or damage resulting from improper use of the light.
3. Attention! Before starting the installation work, make sure that the mains power line is voltage-free—turn off safety cutout or unscrew the protection fuse. The switch must be “OFF”.
4. Warning! Before drilling the mounting holes, make sure that no gas, water or electricity pipes and wires can be drilled through or damaged in your chosen mounting location.
5. Description of the supply terminals: L = Phase N = Neutral conductor  Earthed conductor.

Notiz:

Deutsch

1. Die Leuchten dürfen nur von autorisiertem Fachpersonal nach den jeweils geltenden Elektro- Installationsvorschriften installiert werden.
2. Der Hersteller übernimmt keine Verantwortung für Verletzungen oder Schäden, die Folge eines unsachgemäßen Gebrauchs der Leuchte sind.
3. Achtung! Vor Beginn der Montagearbeiten die Netzleitung spannungsfrei schalten – Sicherungsautomat ausschalten bzw. Sicherung heraus drehen. Schalter auf “AUS”.
4. Achtung! Vergewissern Sie sich vor dem Bohren der Befestigungslöcher, dass an der Bohrstelle keine Gas-, Wasser- oder Stromleitungen angebohrt oder beschädigt werden können.
5. Bezeichnung der Anschlussklemmen: L = Phase N = Neutraleiter  Schutzleiter.

Noter:

Français

1. Les lampes doivent être installées par un personnel spécialisé uniquement, en suivant les instructions d’installation électronique en vigueur.
2. Le fabricant n’est pas responsable des blessures ou des dommages résultant d’une utilisation incorrecte des lampes.
3. Attention! Avant de commencer les travaux de montage, éteindre la tension du cordon d’alimentation— éteindre le disjoncteur ou dévisser les fusibles. Placer le commutateur sur “OFF”.
4. Attention ! Avant le perçage des trous de fixation, assurez-vous qu’il n’y ait aucun dommage causé aux conduites de gaz, d’eau ou électriques à l’endroit du forage.
5. Description des bornes serre-fils : L = Phase N = Conducteur neutre  Câble de protection terre.



EU: G store

EU	REP	<p>Company: E-CrossStu GmbH Address: Mainzer Landstr. 69,60329 Frankfurt am Main Email: E-CrossStu@web.de Nr.202406215376</p> <p>Above address is ONLY for EU representative purpose. NOT INVOLVINGIN ANY SALE OR PRODUCT RETURN. Only manufacturer, importer or seller shall be solely held responsible for product quality or after sale issues.</p>
<p>Importer: foshanshigulakejinchukouyouxiangongsi Address:Danzaozhen jianshalu donggerqu1hao Liandongyougubeiyuan13zuo103shisiceng402 Foshanshi Nanhaiqu Guangdongsheng 52800 CN Manufacturer: Foshan Vance Photoelectric Technology Co.Ltd. 2nd Floor, No 279, Baiannan Road, Junan Town, Shunde District, Foshan, Guangdong, China Contact: Shixi Ding Email: support03@dingliled.com</p>		

EU: N store

EU	REP	<p>Company: E-CrossStu GmbH Address: Mainzer Landstr. 69,60329 Frankfurt am Main Email: E-CrossStu@web.de Nr.202406581022</p> <p>Above address is ONLY for EU representative purpose. NOT INVOLVINGIN ANY SALE OR PRODUCT RETURN. Only manufacturer, importer or seller shall be solely held responsible for product quality or after sale issues.</p>
<p>Importer: Foshanshi wansiguangdian kejiyouxian'gongsi Address: Jun'anzen Jun'anshequ Juminweiyuanhui Baiannanlu 279 hao zhi san Foshanshi Shundequ Guangdongsheng 528300 CN Manufacturer: Foshan Vance Photoelectric Technology Co.Ltd. 2nd Floor, No 279, Baiannan Road, Junan Town, Shunde District, Foshan, Guangdong, China Contact: Shixi Ding Email: support03@dingliled.com</p>		

EU: P store

EU	REP	<p>Company: E-CrossStu GmbH Address: Mainzer Landstr. 69,60329 Frankfurt am Main Email: E-CrossStu@web.de Nr.202406311414</p> <p>Above address is ONLY for EU representative purpose. NOT INVOLVINGIN ANY SALE OR PRODUCT RETURN. Only manufacturer, importer or seller shall be solely held responsible for product quality or after sale issues.</p>
<p>Importer: Foshan BeiMa ZhaoMing KeJi Youxian GongsI Address:Danzao Town, Jinshadongliankaifaqu 2 hao chenhairuichangfang 2 lou Foshan City Nanhai District Guangdong Province 528225 CN Manufacturer: Foshan Vance Photoelectric Technology Co.Ltd. 2nd Floor, No 279, Baiannan Road, Junan Town, Shunde District, Foshan, Guangdong, China Contact: Shixi Ding Email: support03@dingliled.com</p>		



EU: V store

EU	REP	<p>Company: E-CrossStu GmbH Address: Mainzer Landstr. 69,60329 Frankfurt am Main Email: E-CrossStu@web.de Nr.202406422650</p> <p>Above address is ONLY for EU representative purpose. NOT INVOLVINGIN ANY SALE OR PRODUCT RETURN. Only manufacturer, importer or seller shall be solely held responsible for product quality or after sale issues.</p>
<p>Importer: guangzhoushi wansi guangdian keji youxiangongsi Address: huadidadaozhong 295hao erlou guangzhoushi liwanqu guangdongsheng 510000 CN Manufacturer: Foshan Vance Photoelectric Technology Co.Ltd. 2nd Floor, No 279, Baiannan Road, Junan Town, Shunde District, Foshan, Guangdong, China Contact: Shixi Ding Email: support03@dingliled.com</p>		

EU: A store

EU	REP	<p>Company: E-CrossStu GmbH Address: Mainzer Landstr. 69,60329 Frankfurt am Main Email: E-CrossStu@web.de Nr.202507560865</p> <p>Above address is ONLY for EU representative purpose. NOT INVOLVINGIN ANY SALE OR PRODUCT RETURN. Only manufacturer, importer or seller shall be solely held responsible for product quality or after sale issues.</p>
<p>Importer: guangzhoushiliwanquaodingdianqidian Address: Huadidadaozhong No.449 Zibian10-2A(erceng) Liwanqu Guangzhoushi 510385 CN Manufacturer: Foshan Vance Photoelectric Technology Co.Ltd. 2nd Floor, No 279, Baiannan Road, Junan Town, Shunde District, Foshan, Guangdong, China Contact: Shixi Ding Email: support03@dingliled.com</p>		

UK: A store

UK	REP	<p>Company name: YH Consulting Limited Address: C/O YH Consulting Limited Office 147 Centurion House, London Road Staines-upon-Thames, Surrey, TW18 4AX Email: H2YHUK@gmail.com No.202507385279</p> <p>Above address is ONLY for UK representative purpose. NOT INVOLVINGIN ANY SALE OR PRODUCT RETURN. Only manufacturer, importer or seller shall be solely held responsible for product quality or after sale issues.</p>
<p>Importer: guangzhoushiliwanquaodingdianqidian Address: No. 449 Huadi Avenue Middle, Liwan District, self compiled 10-2A (second floor) Manufacturer: Foshan Vance Photoelectric Technology Co.Ltd. 2nd Floor, No 279, Baiannan Road, Junan Town, Shunde District, Foshan, Guangdong, China Contact: Shixi Ding Email: support03@dingliled.com</p>		



UK: P store

UK	REP	<p>Company name: YH Consulting Limited Address: C/O YH Consulting Limited Office 147 Centurion House, London Road Staines-upon-Thames, Surrey, TW184AX Email: H2YHUK@gmail.com No.202406580247</p>
<p>Above address is ONLY for UK representative purpose. NOT INVOLVING IN ANY SALE OR PRODUCT RETURN. Only manufacturer, importer or seller shall be solely held responsible for product quality or after sale issues.</p>		
<p>Importer: Foshan BeiMa ZhaoMing KeJi Youxian Gongs Address: Danzao Town, Jinshadonglianakaifu 2 hao chenhairuichangfang 2 lou Foshan City Nanhai District Guangdong Province 528225 CN Manufacturer: Foshan Vance Photoelectric Technology Co.Ltd. 2nd Floor, No 279, Baiannan Road, Junan Town, Shunde District, Foshan, Guangdong, China Contact: Shixi Ding Email: support03@dingliled.com</p>		

UK: G store

UK	REP	<p>Company name: YH Consulting Limited Address: C/O YH Consulting Limited Office 147 Centurion House, London Road Staines-upon-Thames, Surrey, TW184AX Email: H2YHUK@gmail.com No.202406818374</p>
<p>Above address is ONLY for UK representative purpose. NOT INVOLVING IN ANY SALE OR PRODUCT RETURN. Only manufacturer, importer or seller shall be solely held responsible for product quality or after sale issues.</p>		
<p>Importer: foshanshigulakejinchukouyouxiangongsi Address: Danzaozhen jianshalu dongerqu1hao Liandongyougubeiyuan13zuo103shisiceng402 Foshanshi Nanhaiqu Guangdongsheng 52800 CN Manufacturer: Foshan Vance Photoelectric Technology Co.Ltd. 2nd Floor, No 279, Baiannan Road, Junan Town, Shunde District, Foshan, Guangdong, China Contact: Shixi Ding Email: support03@dingliled.com</p>		

UK: V store

UK	REP	<p>Company name: YH Consulting Limited Address: C/O YH Consulting Limited Office 147 Centurion House, London Road Staines-upon-Thames, Surrey, TW184AX Email: H2YHUK@gmail.com No.202406424460</p>
<p>Above address is ONLY for UK representative purpose. NOT INVOLVING IN ANY SALE OR PRODUCT RETURN. Only manufacturer, importer or seller shall be solely held responsible for product quality or after sale issues.</p>		
<p>Importer: guangzhoushi wansi guangdian keji youxiangongsi Address: huadidadaozhong 295hao erlou guangzhoushi liwanqu guangdongsheng 510000 CN Manufacturer: Foshan Vance Photoelectric Technology Co.Ltd. 2nd Floor, No 279, Baiannan Road, Junan Town, Shunde District, Foshan, Guangdong, China Contact: Shixi Ding Email: support03@dingliled.com</p>		



GET MORE SUPPORT

We believe that after-sales service is an integral part of the customer experience, and we are dedicated to making it as seamless and hassle-free as possible. If you experience any issues while operating our products, please directly reach out to our Customer Support via Amazon Orders. Or you can send your inquiry to our Official Customer Support at:



support@depuley.com



(001)201-365-0018