

INSTALLATION & USER MANUAL

CEILING FAN WITH LIGHT

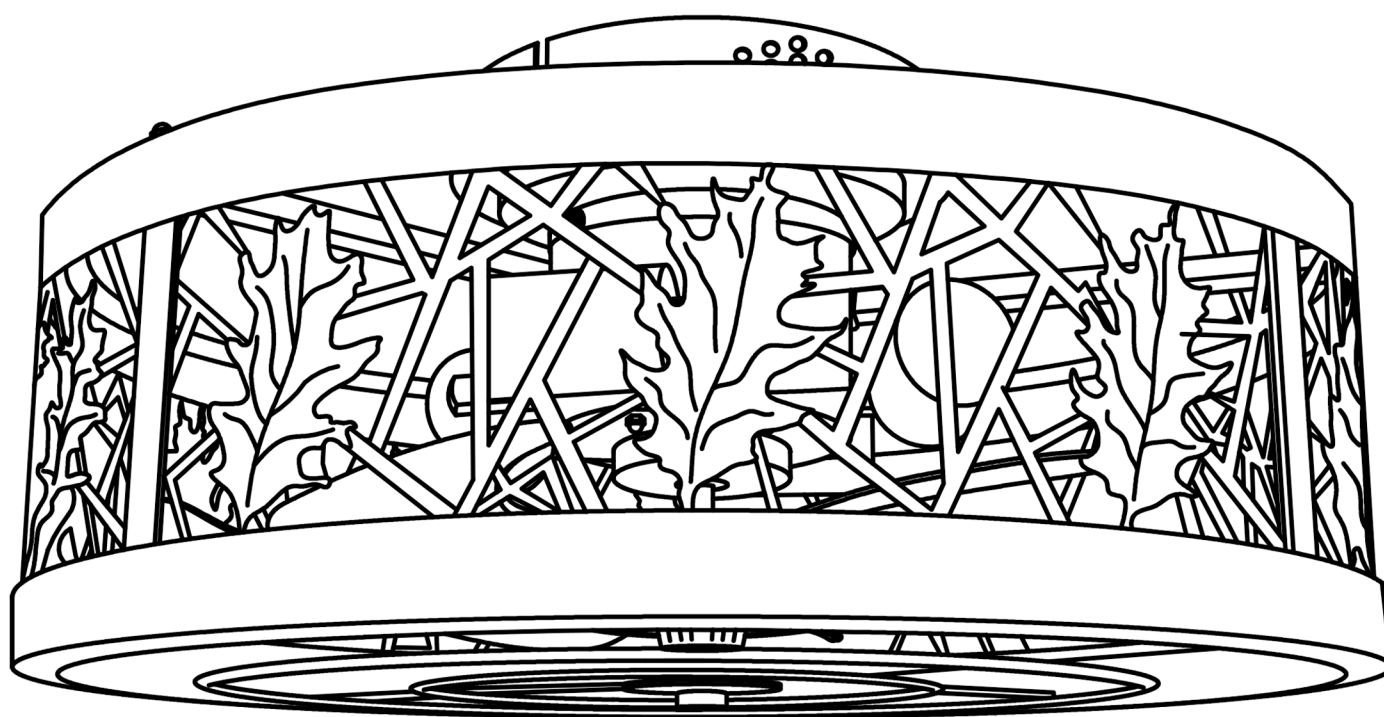

ITEM # 35010

Customer Service: support@breezary.com

Table of Contents

Table of Contents.....	2	Installation Instructions	4-8
Safety Information.....	2	Remote Control Operation.....	9
Dimension Reference.....	3	Troubleshooting.....	10
Hardware Included.....	3		
Fan Parts Included.....	3		

Safety Information

READ AND SAVE THESE INSTRUCTIONS.

1. To reduce the risk of electric shock, ensure electricity has been turned off at the circuit breaker or fuse box before you begin.
2. All wiring must be in accordance with the National Electrical Code “ANSI/NFPA 70” and local electrical codes. Electrical installation should be performed by a qualified licensed electrician.
3. The outlet box and support structure must be securely mounted and capable of reliably supporting a minimum of 35 lbs (15.9 kg). Use only UL Listed outlet boxes marked “Acceptable for Fan Support of 35 lbs. (15.9 kg) or less.”
4. Do not place objects in the path of the blades.
5. To clean the fixture ,turn off the power, wait for it to cool, and wipe the fixture with a clean dry, soft cloth.
6. After making electrical connections, spliced conductors should be turned upward and pushed carefully up into the outlet box. The wires should be spread apart with the grounded conductor and the equipment-grounding conductor on one side of the outlet box and ungrounded conductor on the other side of the outlet box.
7. All screws must be checked and retightened where necessary before installation.



WARNING: To reduce the risk of electrical shock or fire, not use this fan with any solid-state fan speed control device. It will permanently damage the electronic circuitry.



WARNING: To reduce the risk of fire or injury do not use this product in conjunction with any variable (rheostat) wall control.



WARNING: To reduce the risk of personal injury, do not bend the blade brackets when installing the rackets balancing the blades, or cleaning the fan. Do not insert objects.



WARNING: To reduce the risk of fire, electric shock or personal injury, mount to outlet box marked “acceptable for fan support of 35 lbs. (15.9 Kg) or less” and use screws provided with the outlet box.



WARNING: To avoid possible electrical shock, turn the electricity off at the main fuse box before wiring.



WARNING: To reduce the risk of electrical shock, this must be installed with an isolating wall control / switch.



CAUTION: To reduce the risk of personal injury, use only the screws provided with the outlet box.



CAUTION: Please use carefully when working around or cleaning the fan to avoid injury or damage of fan.



CAUTION: The fan must be mounted with a minimum of 7.5 feet (2.3 Meter) clearance from the trailing edge of the blades to the floor.



CAUTION: Changes or modifications not expressly approved by the party responsible for compliance could void the user’s authority to operate the equipment.

Dimension Reference

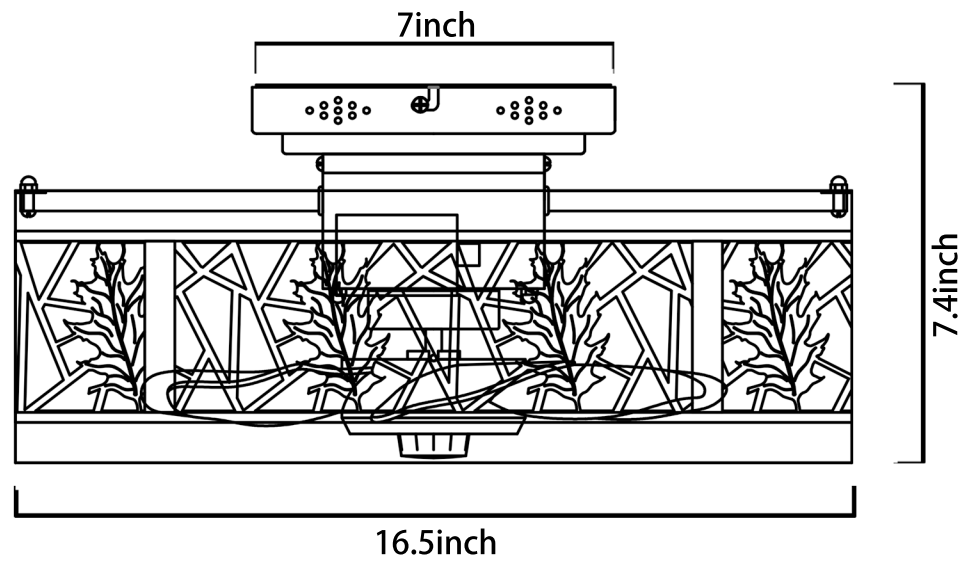

Hardware Included

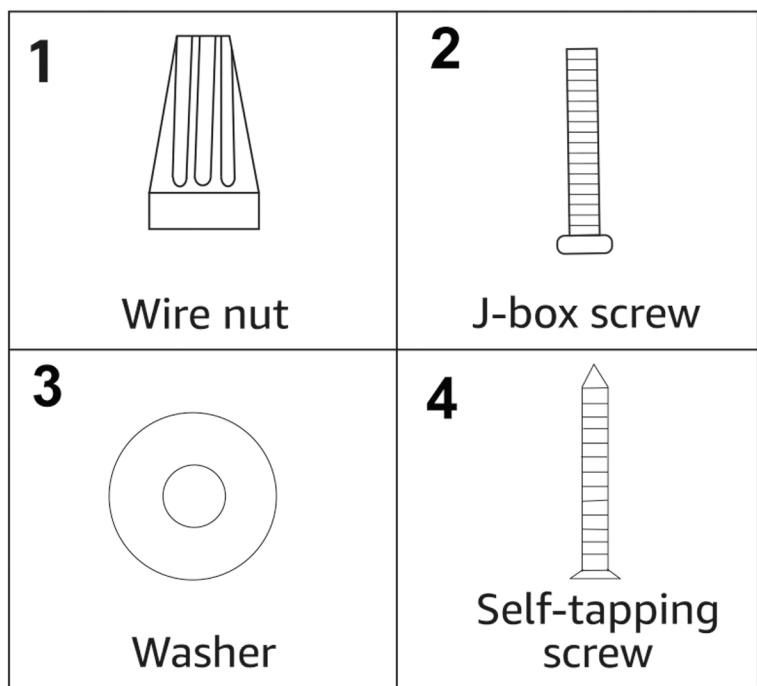

Hardware Package	Quantity
1.Wire Nut	3
2.J-Box Screw	4
3.Washer	4
4.Self-Tapping Screw	4

Fan Parts Included

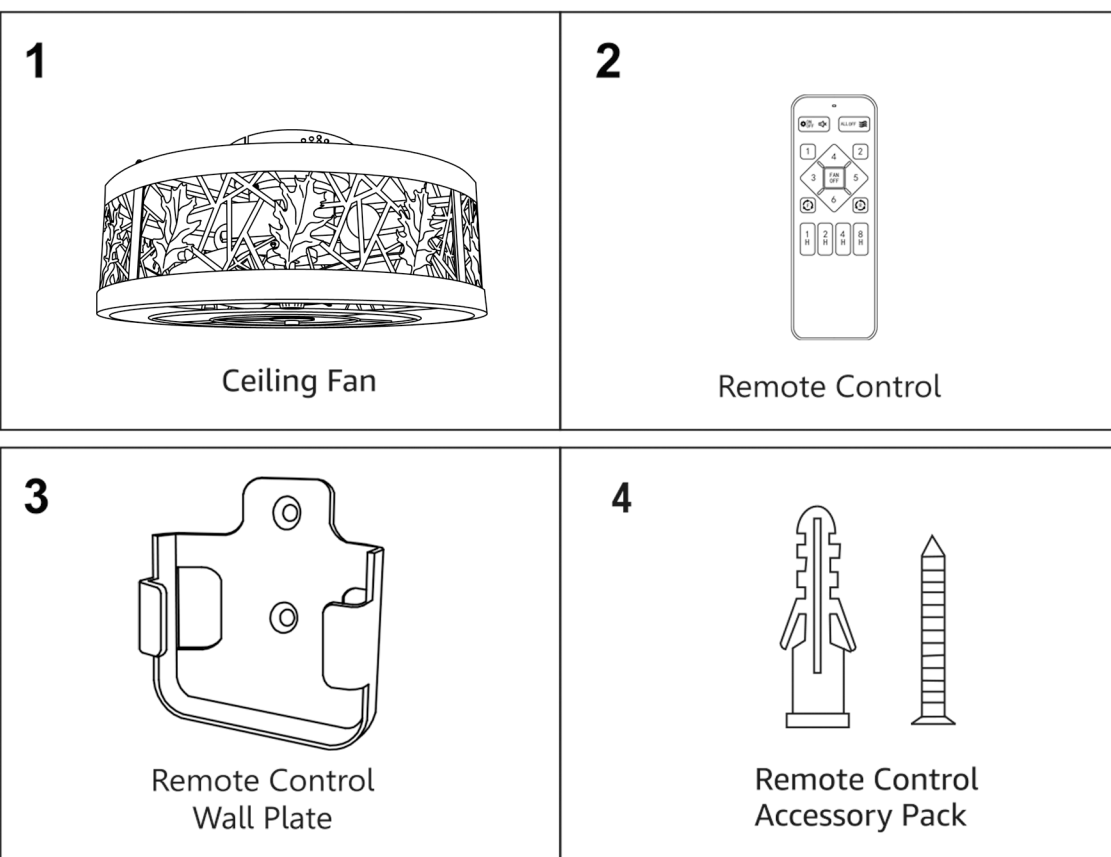

Item Name	Quantity
1.Ceiling Fan	1
2.Remote Control	1
3.Remote Control Wall Plate	1
4.Remote Control Accessory Pack	1

Energy Saving Usage

- Ceiling fan performance and energy savings rely heavily on the proper installation and use of the ceiling fan. Here are a few tips to ensure efficient product performance.

Choosing the Appropriate Mounting Location

Ceiling fans should be installed or mounted in the middle of the room and positioned at least 7.5 feet above the floor and 18 inches away from the walls. If the ceiling height allows, it is recommended to install the fan 7.5~9 feet above the floor to achieve optimal airflow.

Using the Ceiling Fan Year Round

Summer Season: Use the ceiling fan in the counterclockwise direction. Push a breeze downward and make the room feel cooler.

Winter Season: Reverse the motor and operate the ceiling fan at a low speed in the clockwise direction. Circulate warm air evenly and make a room more comfortable.

Electrical and Structural Requirements

- Your new ceiling fan will require a grounded electrical supply line of AC 110-130V/60Hz and a 15 Amp circuit. According to electrical codes, it is necessary to use a fan-rated outlet box to support the additional weight and motion associated with a ceiling fan. A fan-rated box will be clearly labeled as such and is typically designed to support ceiling fans weighing up to 35 pounds. Fan-rated outlet boxes are available in various ratings and designs. It is essential to ensure that the rating of your ceiling fan outlet box meets the requirements for the specific ceiling fan you are installing.
- If your fan is to replace an existing light fixture, turn power off at the main fuse box and remove the existing light fixture.

WARNING

To ensure safety and prevent potential electrical shock, it is not sufficient to simply turn off the wall switch. Prior to wiring, make sure to turn off the electricity at the main fuse box. All wiring should be done in accordance with national and local electrical codes. Additionally, it is important to properly ground the ceiling fan as a precautionary measure against possible electrical shock. Following these guidelines will help ensure the safe installation and operation of your ceiling fan.

WARNING

Do not use a variable (rheostat) wall controller or dimmer switch to operate this fan. Doing so can cause damage to the ceiling fan's remote control unit. It is recommended to only use the provided remote control.

Installation

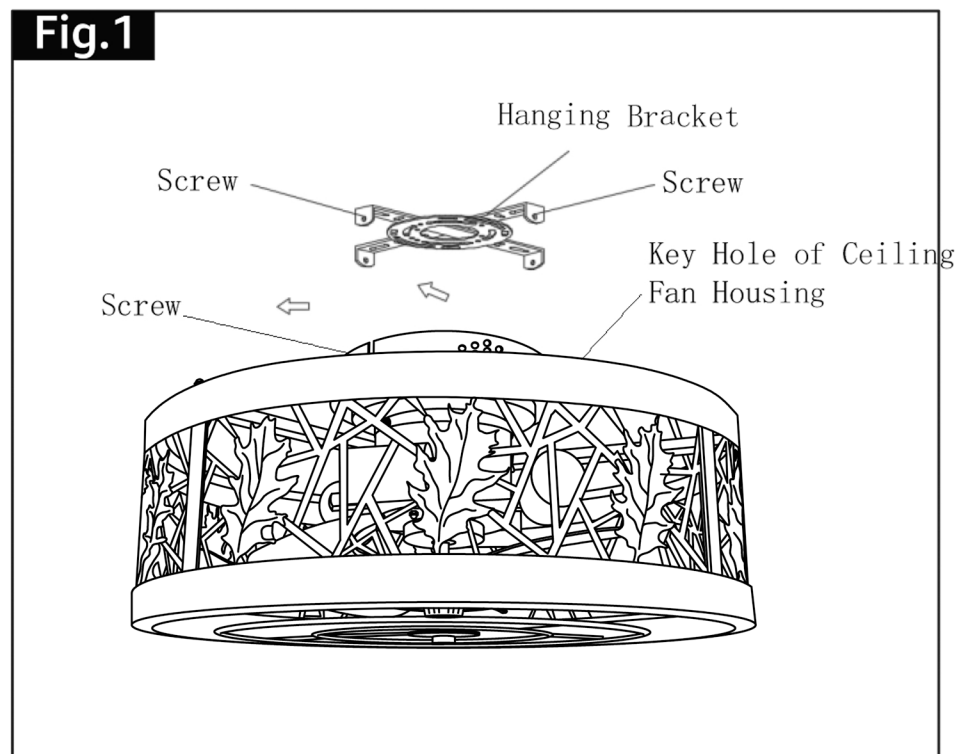

- Take out the hanging bracket

Remove the screw from the circular hole. Keep the screw that removed aside for use later.

loosen the other two screws from the two key holes approximately 1/4 turn. Turn the key holes of the ceiling fan housing from the two screws loosened previously and remove the hanging bracket from the ceiling fan.

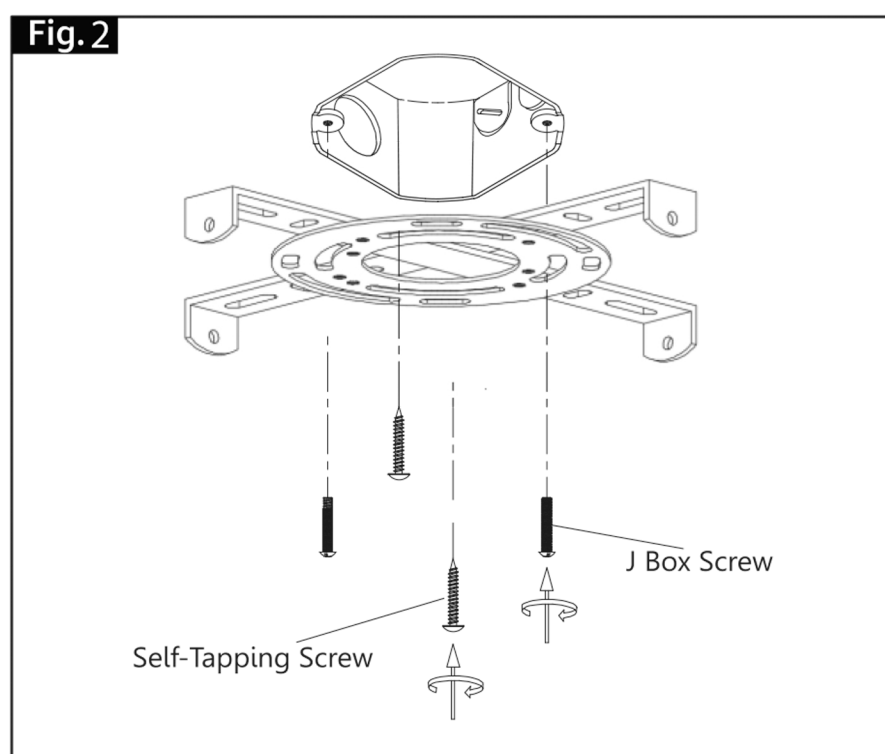

Attach the hanging bracket to the outlet box (not included) with the two J box screws provided. Secure the hanging bracket to the ceiling with the two self-tapping screws provided.

Fig. 3

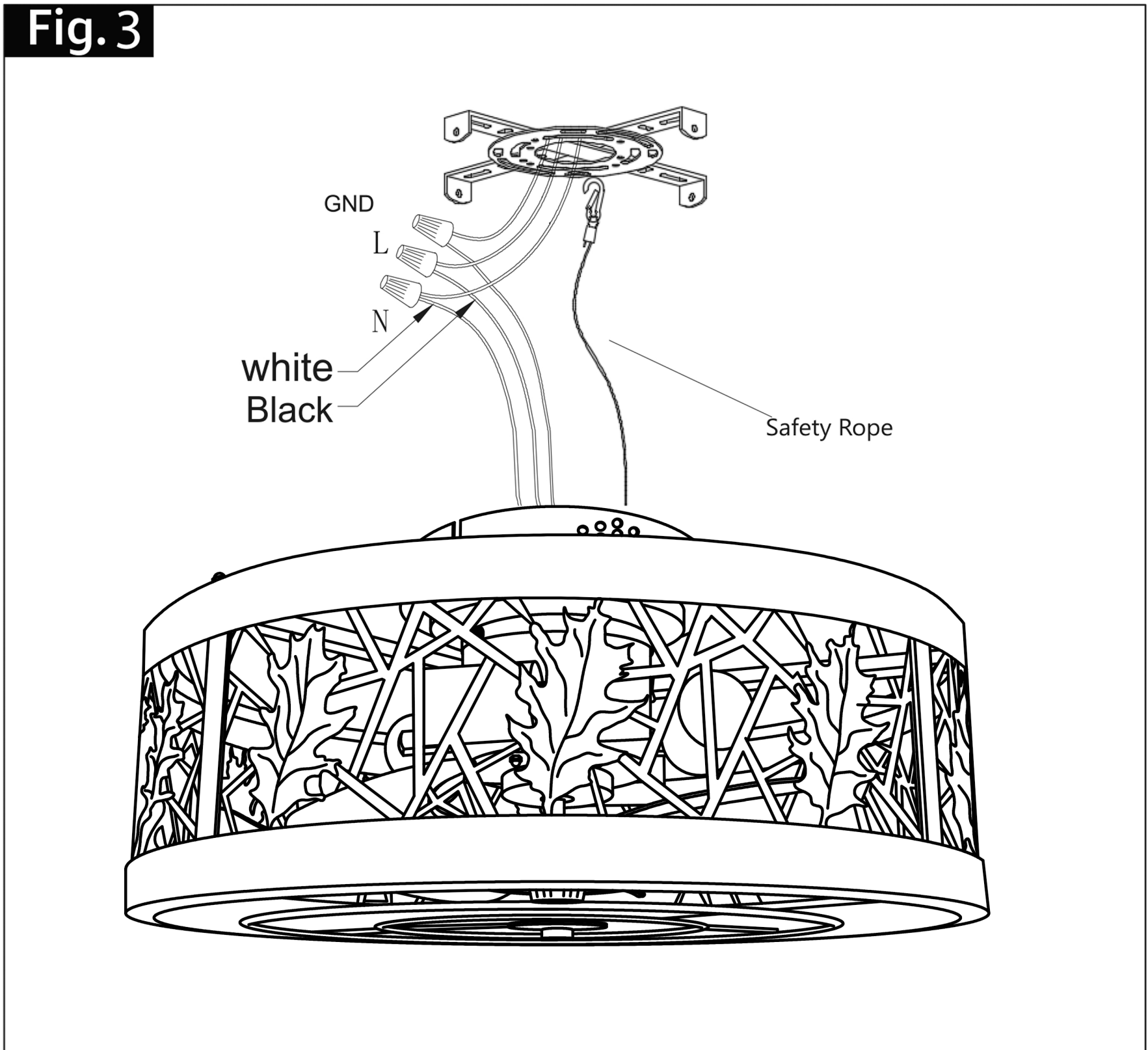

- **Wiring**

TIPS: To facilitate wiring, please use a safety rope to hang the ceiling fan. Connect the "Neutral wire" (white wire) from the ceiling to the white wire of ceiling fan.

Connect the "Live wire" (black wire) from the ceiling to the black wire of ceiling fan.

Connect the "Ground wire"

(green or yellow/green or bare) from the ceiling to the green wires from the hanging bracket and ceiling fan.

Installation Instructions

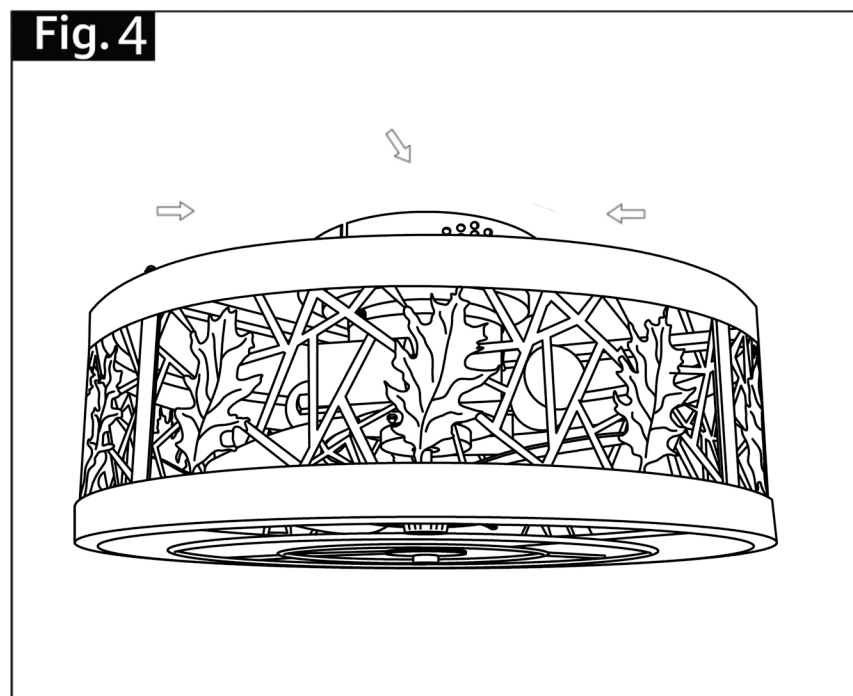



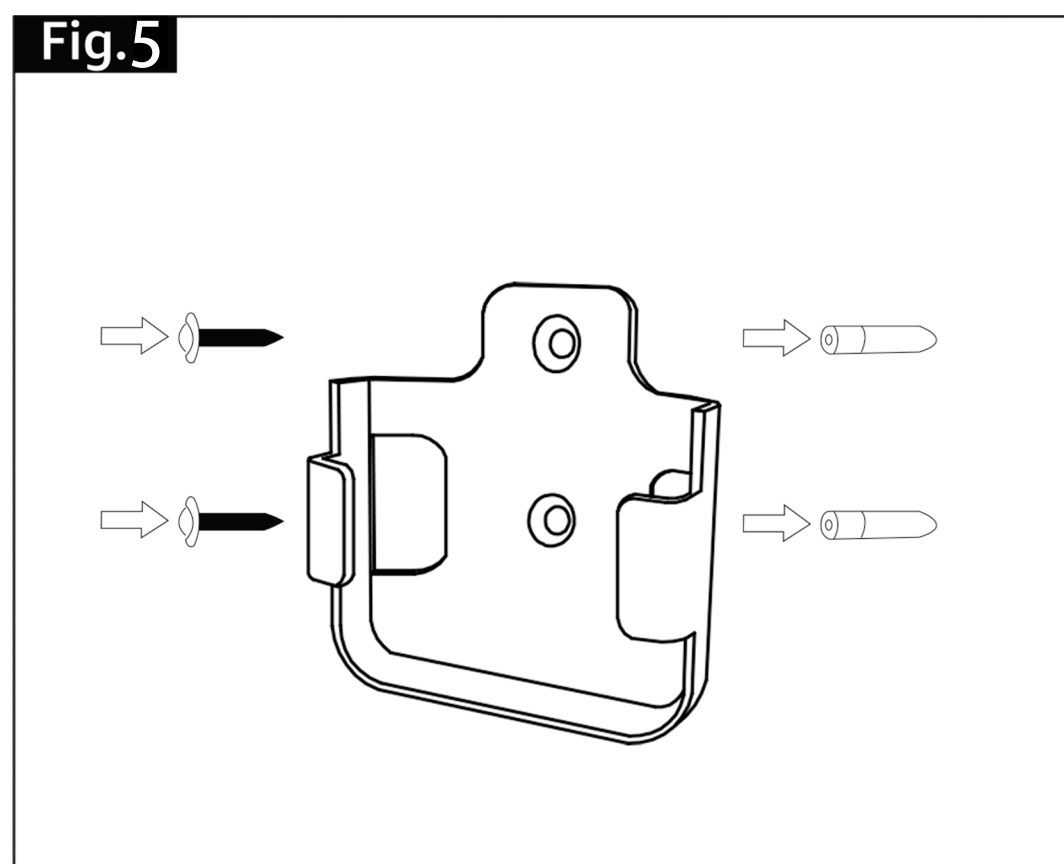



Place the two key holes from the ceiling fan over the two screws previously loosened from the hanging bracket. Turn the ceiling fan until it locks in place at the end of the key holes. Secure by tightening the two screws previously loosened and the one screw previously removed.

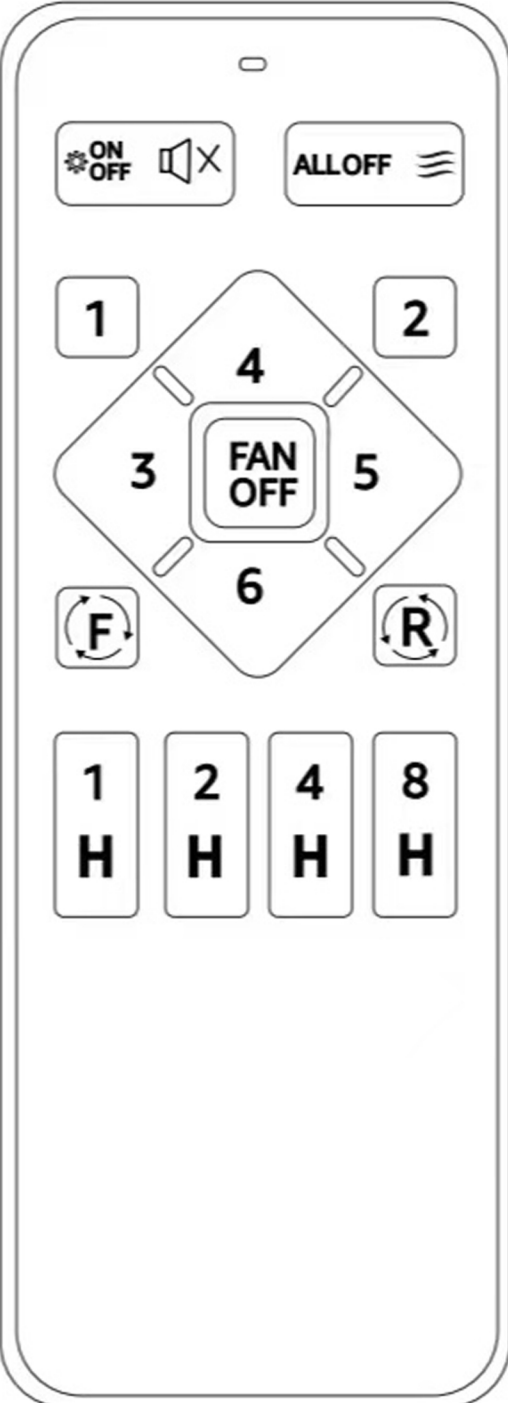

- **Installing Wall Plate**

Attach wall plate using the two screws and two plastic anchors provided in remote control accessory pack.

Remote Control

	ALLOFF	Light & Fan all OFF
	1-6	Fan Speed
	Fan Off	Fan Off(Long-press within 5s after wall switch on to pair)
	  	Forward Reverse Natural Wind
 	Light On/Off Remote controller mute	
1H	Fan stop & light off after 1 hour	
2H	Fan stop & light off after 2 hours	
4H	Fan stop & light off after 4 hours	
8H	Fan stop & light off after 8 hours	

Troubleshooting Guide

<p>If Fan Does Not Start</p>	<ol style="list-style-type: none"> 1. Check the main and branch circuit fuses or circuit breakers. 2. Ensure that the wall control is turned "ON", do not use dimmer switch. 3. Check the line wire connections to the fan and switch wire connections in the switch housing. <p>CAUTION: Make sure to turn off the main power before making any electrical connections.</p>
<p>If The Fan Sounds Noisy</p>	<ol style="list-style-type: none"> 1. Make sure all screws in the motor housing are snug (not over tightened). 2. Check that wire connectors in the switch housing are not rattling against each other or the interior wall of the switch housing. CAUTION: Turn off the main power before entering the switch housing. 3. Ensure that the screws securing are tight. Make sure the light bulb is tight in the socket and not touching the lamp frame or blades. 4. Note that some fan motors are sensitive to signals from Solid State variable speed controls. DO NOT USE a Solid State variable speed control. 5. Allow a "break-in" period of 24 hours. Most noises associated with a new fan will disappear after this period.
<p>If Fan Wobbles</p>	<ol style="list-style-type: none"> 1. Check that all blades are screwed firmly into blade holders. 2. Make sure that the canopy and mounting plate are tightened securely to the ceiling junction box, and the junction box is mounted firmly to the ceiling joist. 3. Ensure the concave groove of the hanger ball is positioned on the hanger lug of the mounting bracket.
<p>If Light Does Not Work</p>	<ol style="list-style-type: none"> 1. Check the black wiring of motor to receiver, and receiver to AC input. 2. Check for loose or disconnected wires in the fan switch housing. 3. Check for loose for light bulbs. 4. Check for faulty light bulbs, make sure the light bulb is AC120V and E26 medium base. <p>CAUTION: Make sure the main circuit is turned off before entering the switch housing.</p>
<p>Remote Does Not Work</p>	<ol style="list-style-type: none"> 1. Battery out of power or not installed correctly; change new AAA battery and ensure well installed. 2. Remote controller not paired, make new pairing with light.