

HOUSE BED
ASSEMBLY INSTRUCTIONS
SKU MF286613

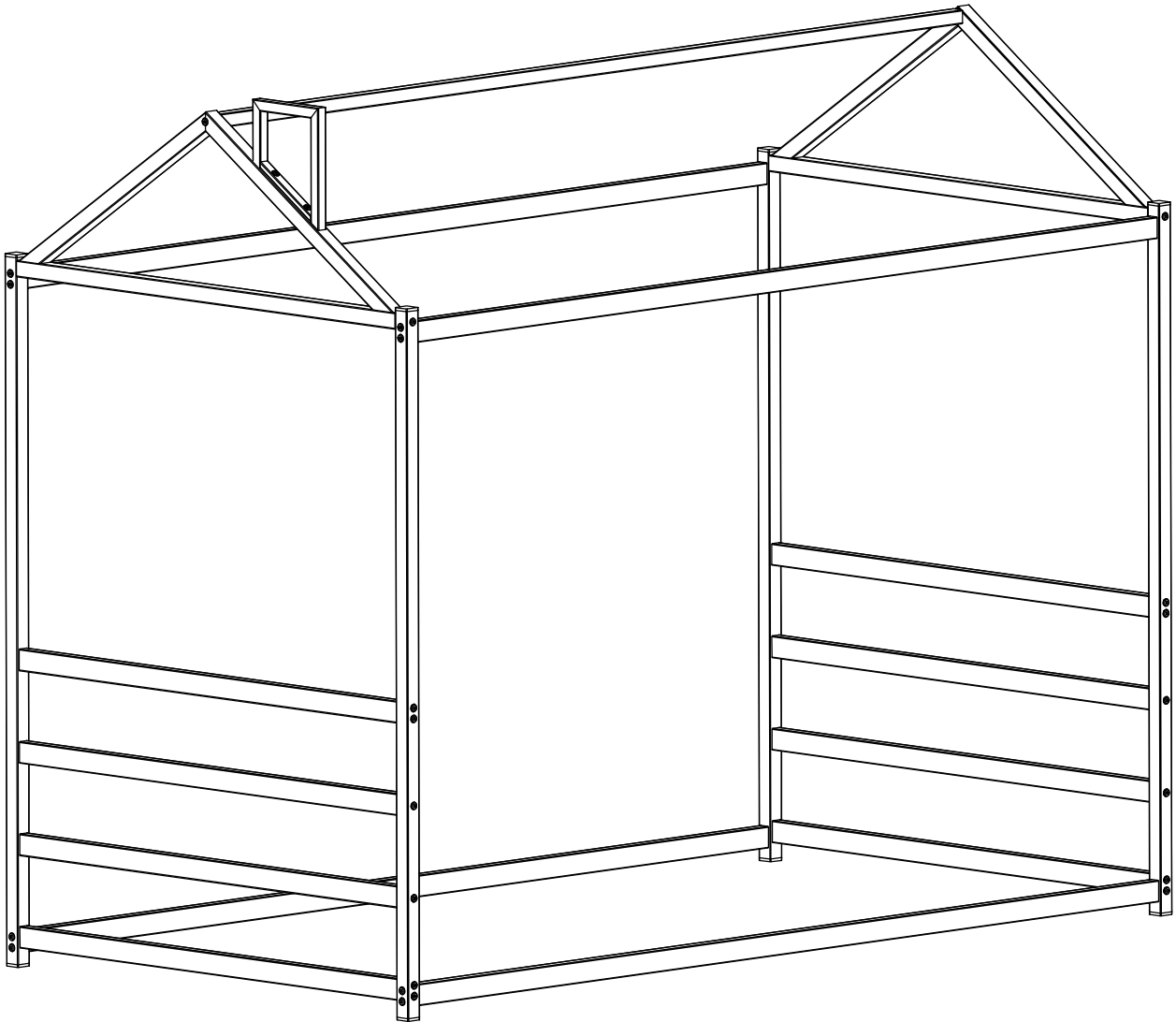

If you have any questions, please feel free to
contact us.
Email: service@qualfurn.net

HOUSE BED
ASSEMBLY INSTRUCTIONS
SKU MF286613



SAFETY WARNINGS AND GENERAL NOTES:

1. Do not use substitute parts. Contact the manufacturer or dealer for replacement parts.
2. Keep these instructions for future reference.
3. We recommend assembling your bed on the shipping carton to protect your floor or carpet.
4. Be certain all staples are out of the box before beginning assembly on the shipping carton.
5. Replacement Parts:
Replacement Parts, including additional guardrails, may be obtained from any of our (GIGACLOUD TECHNOLOGY (USA) INC.) dealers

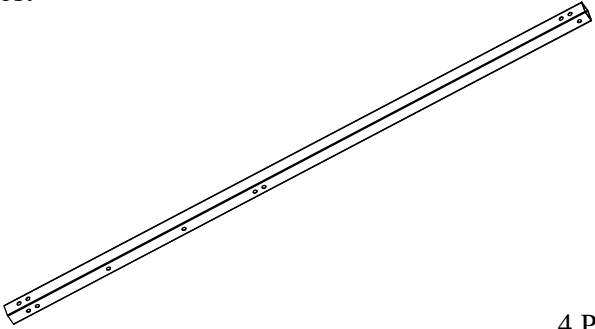
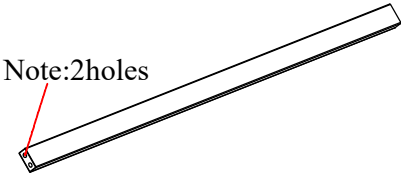
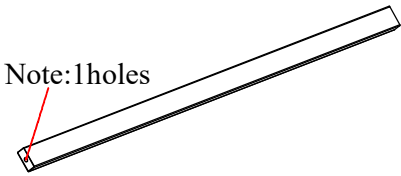
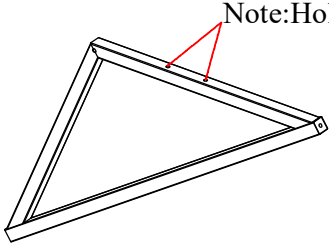
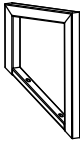
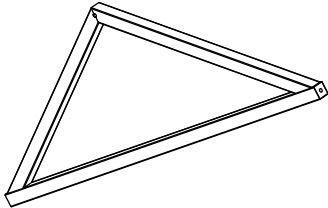
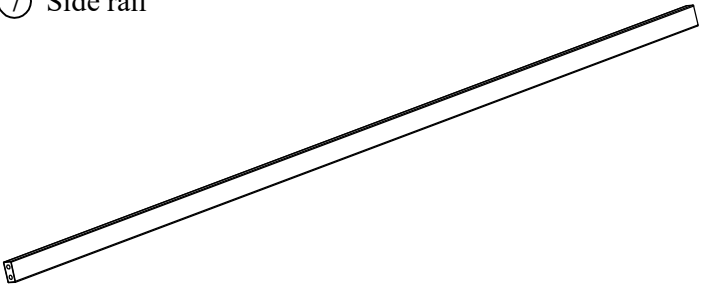
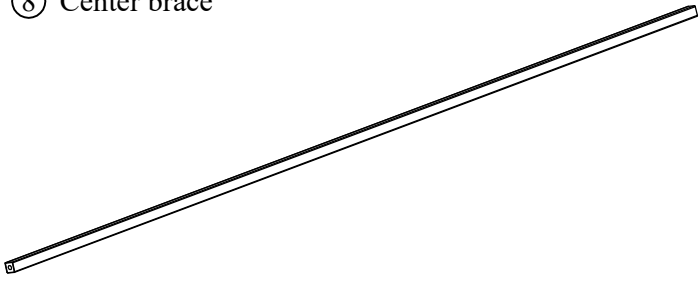
**HOUSE BED
ASSEMBLY INSTRUCTIONS
SKU MF286613**

<p>① Post</p>  <p style="text-align: right;">4 PCS</p>	<p>② End rail</p>  <p>Note: 2 holes</p> <p style="text-align: right;">4 PCS</p>
<p>③ End rail</p>  <p>Note: 1 hole</p> <p style="text-align: right;">4 PCS</p>	<p>④ End guard rail</p>  <p>Note: Hole</p> <p style="text-align: right;">1 PC</p>
<p>⑤ End guard rail</p>  <p style="text-align: right;">1 PC</p>	<p>⑥ End guard rail</p>  <p style="text-align: right;">1 PC</p>
<p>⑦ Side rail</p>  <p style="text-align: right;">4 PCS</p>	<p>⑧ Center brace</p>  <p style="text-align: right;">1 PC</p>

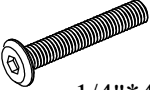
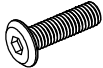
HARDWARE LIST

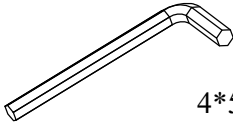
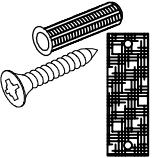
<p>Ⓐ Bolts</p>  <p style="text-align: center;">1/4"*45 46PCS</p>	<p>Ⓑ Bolts</p>  <p style="text-align: center;">1/4"*25 2PCS</p>	<p>Ⓒ End cap</p>  <p style="text-align: center;">30*30 8PCS</p>	<p>Ⓓ Allen key</p>  <p style="text-align: center;">4*59 1PC</p>	<p>Ⓔ Connect wall</p>  <p style="text-align: center;">1/4"*40 2 SET</p>
---	--	--	---	--

HOUSE BED
ASSEMBLY INSTRUCTIONS
SKU MF286613

DETAIL VIEW

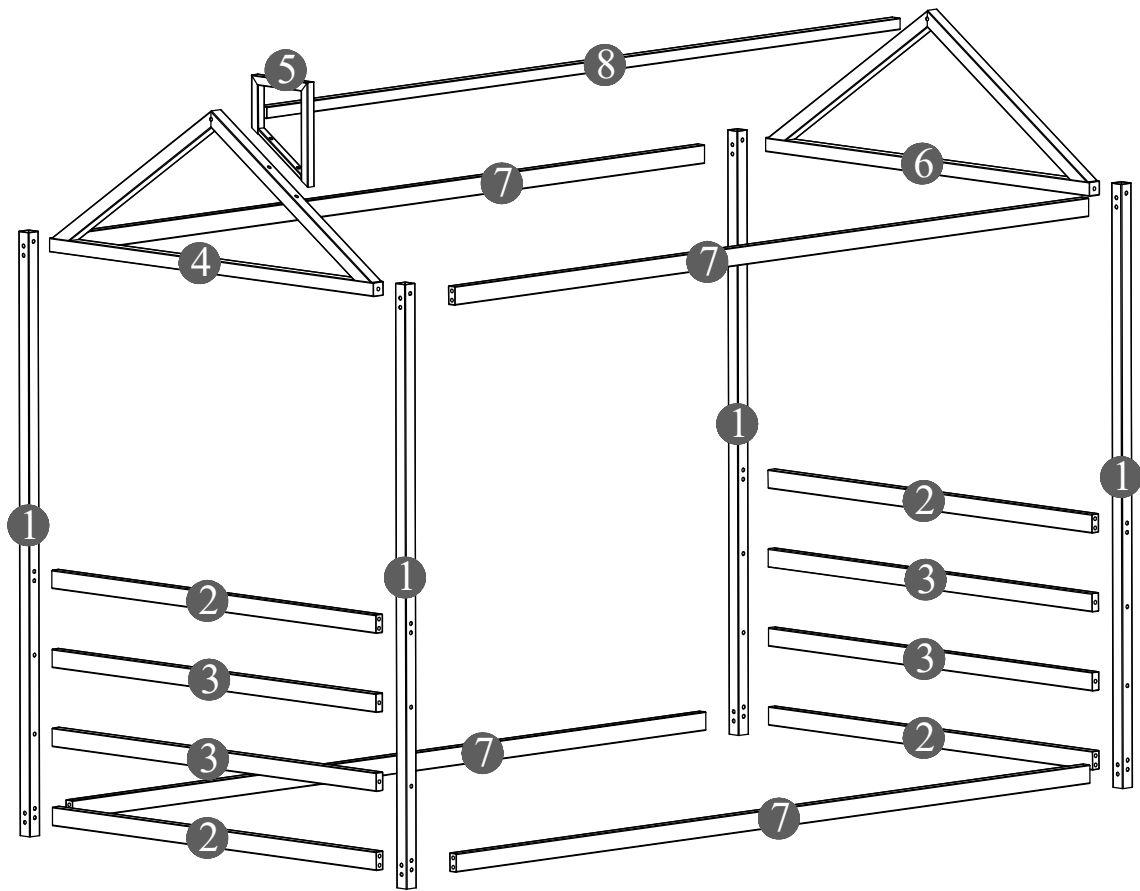

HOUSE BED ASSEMBLY INSTRUCTIONS SKU MF286613

STEP 1 : Following below illustration Assembly Frame #1. Using hardware #A, #B, #C connect #1 with #2, #3, #4, #5 to complete Frame #1.

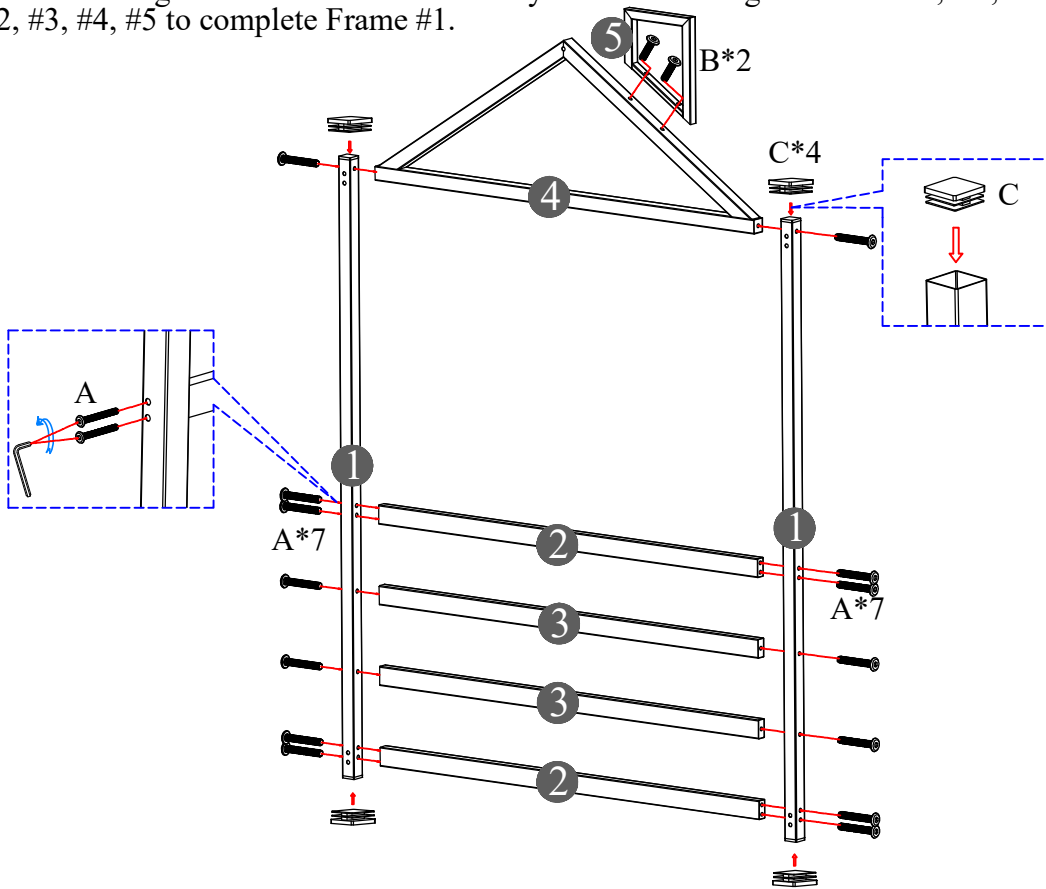

NOTE: In this step, DO NOT tighten any bolt until you connect all part together.

STEP 2 : Following below illustration Assembly Frame #2. Using hardware #A, #C connect #1 with #2, #3, #6 to complete Frame #1.

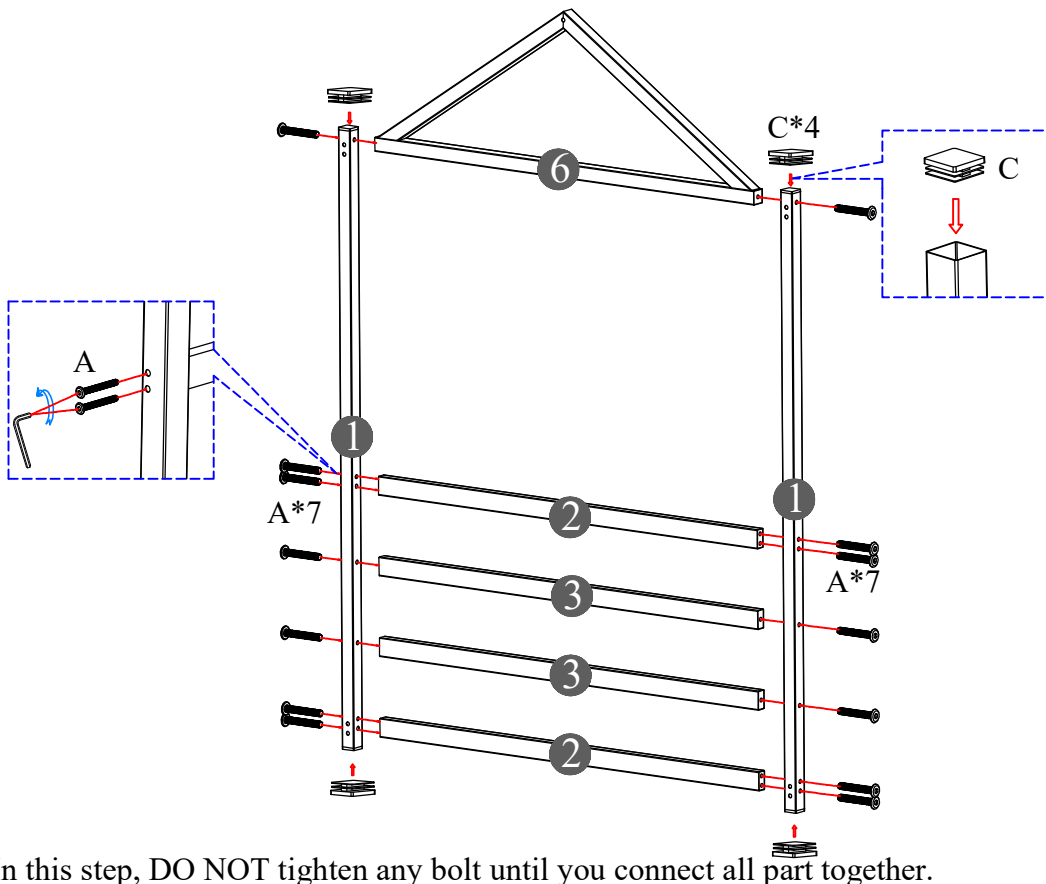

NOTE: In this step, DO NOT tighten any bolt until you connect all part together.

HOUSE BED
ASSEMBLY INSTRUCTIONS
SKU MF286613

STEP 3 : Following below illustration Assembly Frame #3.Using hardware #A connect Frame #1,Frame #2 with #7, #8 to complete Frame #3.

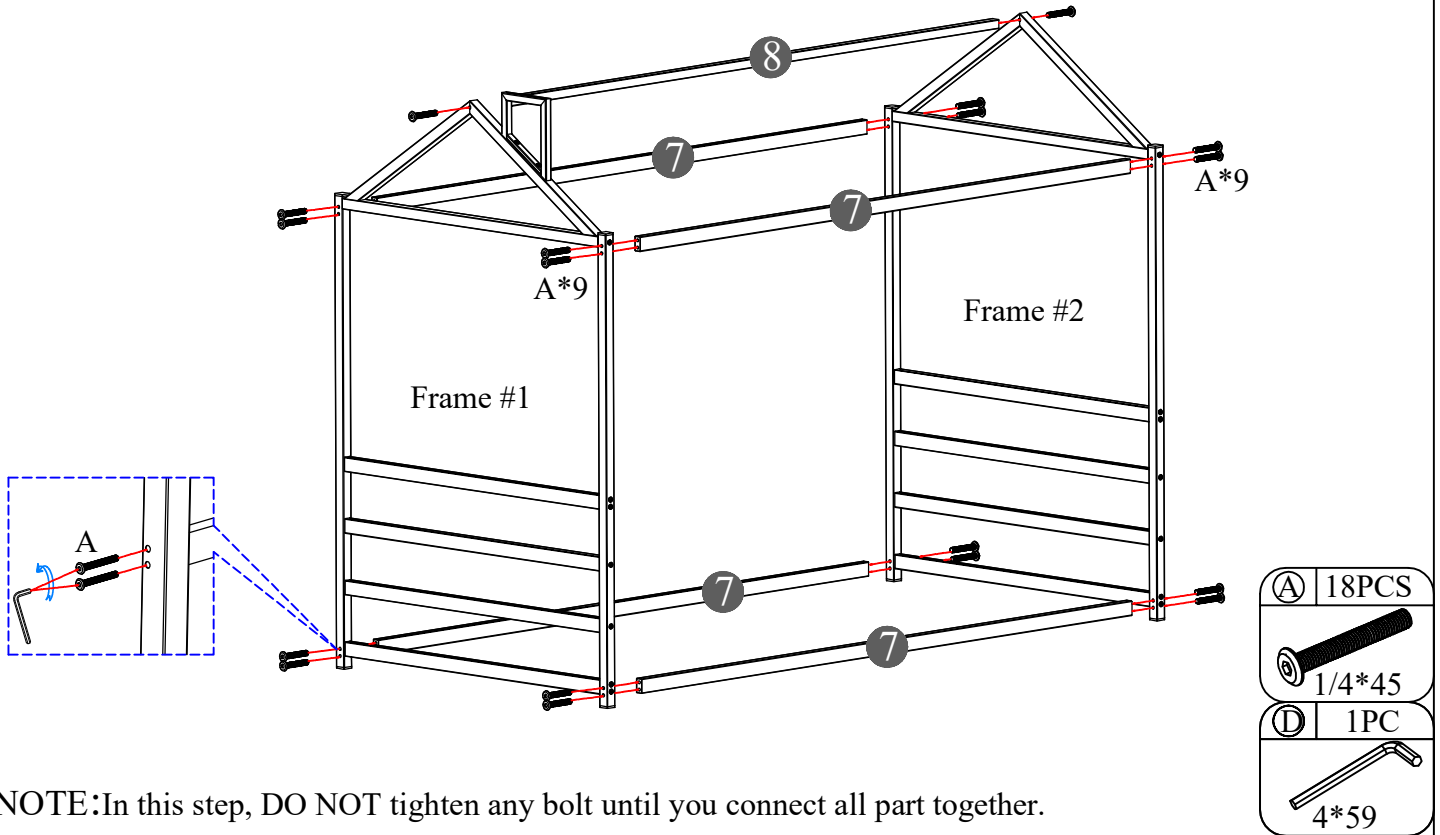

NOTE:In this step, DO NOT tighten any bolt until you connect all part together.

STEP 4 : Following below illustration Assembly Frame #4. Using hardware #E connect Frame #3 with Wall to complete .
COMPLETED HOUSE BED

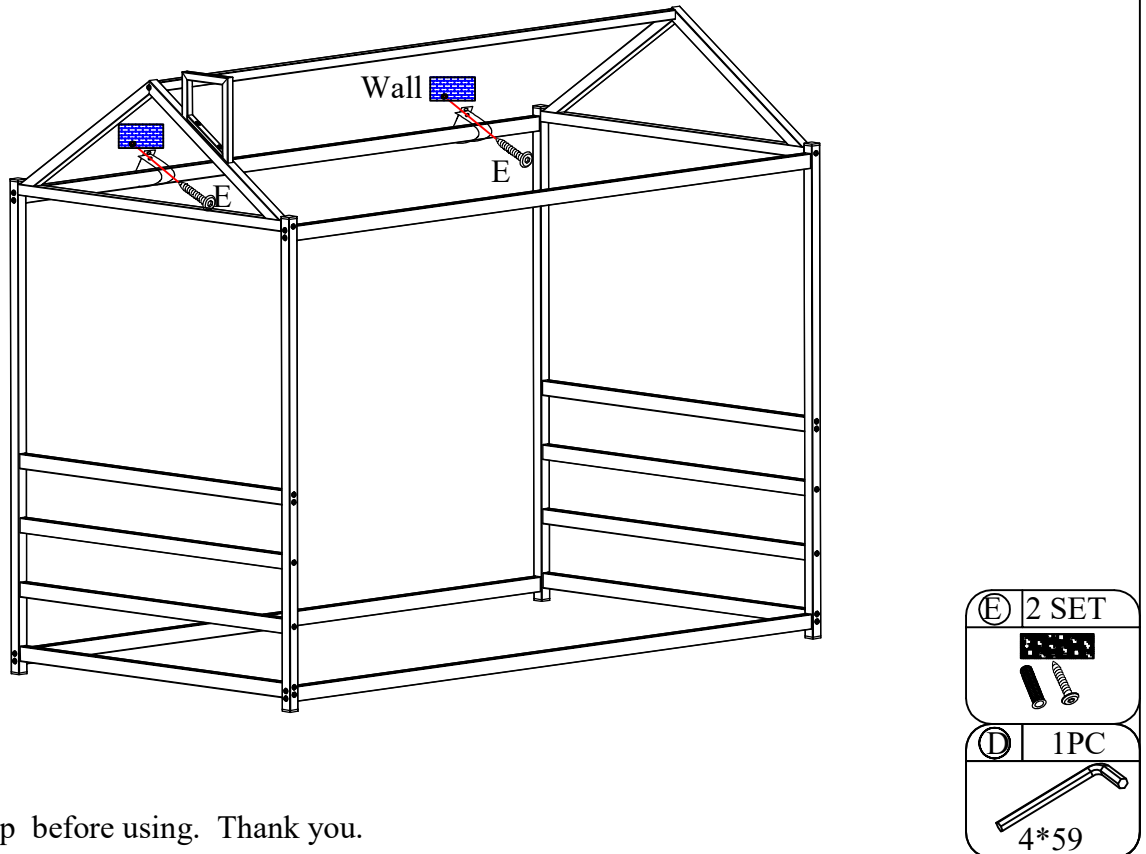

NOTE: Tighten all step before using. Thank you.