



Ludington®

24" undermount single-bowl kitchen sink

20023

Features

- No faucet holes; requires wall- or counter-mount faucet
- 9-7/16" depth
- 3-3/4" (94 mm) drain opening

Material

- Stainless steel with satin finish
- Premium 18-gauge stainless steel

Installation

- Undermount

Recommended Products/Accessories

- 7400 Stainless Steel Sink Drain and Strainer
- 20284 Silicone sink mat
- K-23726 Drain treatment
- K-23729 Stainless steel cleaner



Codes/Standards

ASME A112.19.3/CSA B45.4

STERLING® Stainless Steel Sinks Lifetime Limited Warranty

See website for detailed warranty information.

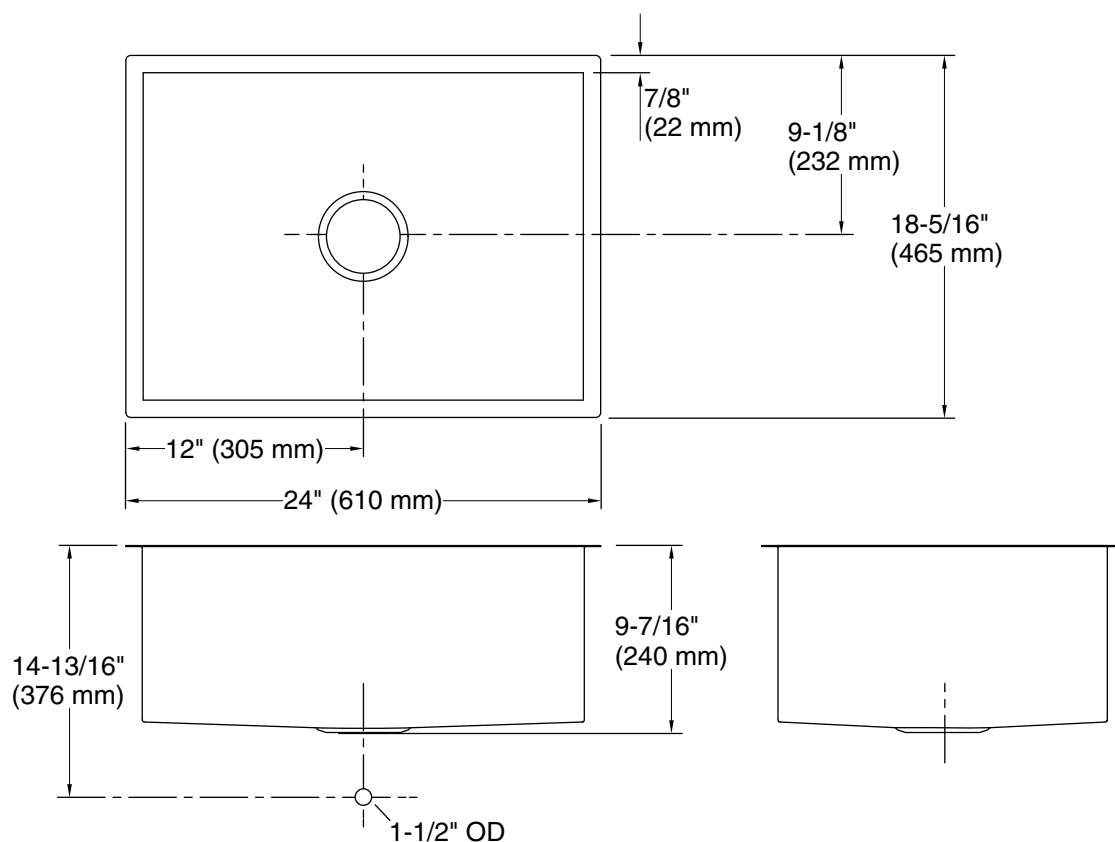

Technical Information

All product dimensions are nominal.

Basin configuration: Single Bowl

Min. base cabinet width: 27" (686 mm)

Bowl area (Only): Length: 22-1/4" (565 mm)
Width: 16-9/16" (420 mm)
Bowl depth: 9-1/16" (230 mm)
Water depth: 9-7/16" (240 mm)

Drain hole: 3-3/4" (94 mm)

Template: Undermount, 1298948-7, required, included

Notes

Install this product according to the installation instructions.

Countertop manufacturer or cutter must use the cut-out template provided with the product, or a current one provided by Kohler Co. (call 1-800-43-FOCUS). Kohler Co. is not responsible for cut-out errors when the incorrect cut-out template is used.