







VEVOR

Upgrade · The Home Creator Way

HEAVY DUTY DRAWER SLIDES

7601 / 7601Z

VEVOR Support Center

1	7601/7601Z -24"		2	7601/7601 Z-30"	
3	7601/7601Z -32"		4	7601/7601 Z-36"	
5	7601/7601Z -40"		6	7601/7601 Z-48"	
7	7601/7601Z -60"				

MODEL2:7601/7601Z



This is the original instruction, please read all manual instructions carefully before operating. VEVOR reserves a clear interpretation of our user manual. The appearance of the product shall be subject to the product you received. Please forgive us that we won't inform you again if there are any technology or software updates on our product.



Warning-To reduce the risk of injury, user must read instructions manual carefully.

WARNING:

1.The product complies with relevant standards and regulations. Installation of this device must comply with all applicable regulations, and it should only be operated in well-ventilated areas. Please read the user

manual before installing and using this equipment.



2. Please wear safety goggles and work gloves properly during assembly.
3. Do not try to assemble the product when feeling tired or when under the influence of alcohol, drugs, or medication.
4. Load-bearing capacity and other product parameters are applied to the properly and completely assembled product only.
5. Separate and count all parts and hardware.
6. Prepare the following tool: Philips Head Screwdriver.
7. If using power tools, please be careful to slow down and stop when needed.
8. Two people are required for assembly.
9. Follow the intended uses only.



Save the instructions.

Attention:





1. Pay attention to waterproof and moisture-proof, should not be placed in the open air, wet or chemical environment.
2. Pay attention to strong chemicals, do not use strong chemicals, cleaning agents or strong detergents to clean products. Clean the appearance of the product stains can be wiped with a clean cloth.
3. Pay attention to anti-high temperature, do not put the product in an environment where the temperature is too high (recommended product environmental requirements: working temperature :-10°C-50°C).

7601/7601Z-16"~7601/7601Z-30"

Part List					
Code	Picture	Qty.	Code	Picture	Qty.
1		1	2		1

3		16	4		16
----------	---	-----------	----------	---	-----------

7601/7601Z-32"~7601/7601Z-60"

Part List					
Code	Picture	Qty.	Code	Picture	Qty.
1		1	2		1
3		24	4		24

Product Introduction

Model	Applicable Drawer Length (inch)	Sliding Length (mm)	Max. Load (kg / lbs)
7601/7601Z-24"	24.5	610	169.2/376
7601/7601Z-30"	30.5	762	155.4/343
7601/7601Z-32"	32.5	813	155.4/332
7601/7601Z-36"	36.5	914	139.5/310
7601/7601Z-40"	40.5	1016	129.6/288
7601/7601Z-48"	48.5	1219	105.3/243
7601/7601Z-60"	60.5	1524	80/178

7601 Installation Hole Pattern(Units:mm)

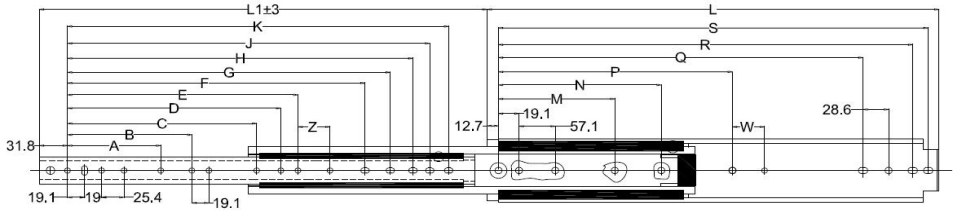

Ltem No	L	A	B	C	D	E	F	G	H	J	K	M	N	P	Q	R	S
18"	457.2	127					246.1	306.3	331.7	350.8	369.8				355.6	412.8	431.8
20"	508	127	190.5				296.9	357.1	382.5	401.6	420.6				406.4	463.6	482.6
22"	558.8	127	190.5				347.7	407.9	433.3	452.4	471.4				457.2	514.4	533.4
24"	609.6	127	190.5				398.5	458.7	484.1	503.2	522.2				508	565.2	584.2
28"	711.2	127	190.5				500.1	560.3	585.7	604.8	623.8				609.6	666.8	685.8
30"	762	127	190.5	368.3			550.9	611.1	636.5	655.6	674.6	234.9		501.6	660.4	717.6	736.6
32"	812.8	127	190.5	368.3			601.7	661.9	687.3	706.4	725.4	234.9	393.7	552.5	711.2	768.4	787.4
36"	914.4	127	190.5	368.3	520.7		703.3	763.5	788.9	808	827	234.9	444.5	654.1	812.8	870	889
38"	965.2	127	190.5	368.3	520.7		754.1	814.3	839.7	858.8	877.8	234.9	469.9	704.9	863.6	920.8	939.8
40"	1016	127	190.5	368.3	520.7		804.9	865.1	890.5	909.6	928.6	234.9	495.3	755.7	914.4	971.6	990.6
44"	1117.6	127	190.5	368.3	520.7		906.5	966.7	992.1	1011.2	1030.2	234.9	546.1	857.3	1016	1073.2	1092.2
48"	1219.2	127	190.5	368.3	520.7	825.5	1008.1	1068.3	1093.7	1112.8	1131.8	234.9	596.9	958.8	1117.6	1174.8	1193.8
52"	1320.8	127	190.5	368.3	520.7	825.5	1109.7	1169.9	1195.3	1214.4	1233.4	234.9	596.9	958.8	1219.2	1276.4	1295.4
56"	1422.4	127	190.5	368.3	520.7	825.5	1211.3	1271.5	1296.9	1316	1335	234.9	596.9	958.8	1320.8	1378	1397
60"	1524	127	190.5	368.3	520.7	825.5	1312.9	1373.1	1398.5	1417.6	1436.6	234.9	596.9	958.8	1422.4	1479.6	1498.6

7601Z Installation Hole Pattern(Units:mm)

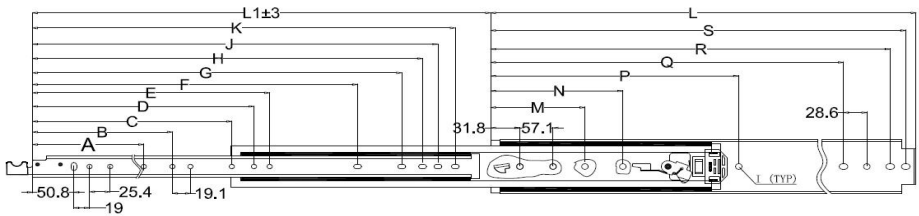

Ltem No	L	A	B	C	D	E	F	G	H	J	K	M	N	P	Q	R	S
18"	457.2	158.8						338.1	363.5	382.5	401.6				368.3	425.5	444.5
20"	508	158.8	222.3				328.7	388.9	414.3	433.3	452.4				419.1	476.3	495.3
22"	558.8	158.8	222.3				379.5	439.7	465.1	484.1	503.2				469.9	527.1	546.1
24"	609.6	158.8	222.3				430.3	490.5	515.9	534.9	554				520.7	577.9	596.9
28"	711.2	158.8	222.3				531.9	592.1	617.5	636.5	655.6				622.3	679.5	698.5
30"	762	158.8	222.3				582.2	642.4	667.8	686.8	705.9	247.6		514.3	673.1	730.3	749.3
32"	812.8	158.8	222.3	387.6			633.5	693.7	719.1	738.1	757.2	247.6	406.4	565.2	723.9	781.1	800.1
36"	914.4	158.8	222.3	400.1	552.5		735.1	795.3	820.7	839.7	858.8	247.6	457.2	666.8	825.5	882.7	898.4
38"	965.2	158.8	222.3	400.1	552.5		785.9	846.1	871.5	890.5	909.6	247.6	482.6	717.6	876.3	933.5	952.5
40"	1016	158.8	222.3	400.1	577.9		836.7	896.9	922.3	941.3	960.4	247.6	508	768.4	927.1	984.3	1003.3
44"	1117.6	158.8	222.3	400.1	755.6		938.3	998.5	1023.9	1042.9	1062	247.6	558.8	870	1028.7	1085.9	1104.9
48"	1219.2	158.8	222.3	400.1	552.5	857.3	1039.9	1100.1	1125.5	1144.5	1163.6	247.6	609.6	971.5	1130.3	1187.5	1206.5
52"	1320.8	158.8	222.3	400.1	552.5	857.3	1141.5	1201.7	1227.1	1246.1	1265.2	247.6	609.6	971.5	1231.9	1289.1	1308.1
56"	1422.4	158.8	222.3	400.1	552.5	857.3	1243.1	1303.3	1328.7	1347.7	1366.8	247.6	609.6	971.5	1333.5	1390.7	1409.7
60"	1524	158.8	222.3	400.1	552.5	857.3	1344.7	1404.9	1430.3	1449.3	1468.4	247.6	609.6	971.5	1435.1	1492.3	1511.3

Installation Procedure(Method 1)

1. Pay attention to the installation space on both sides.(Units:mm)

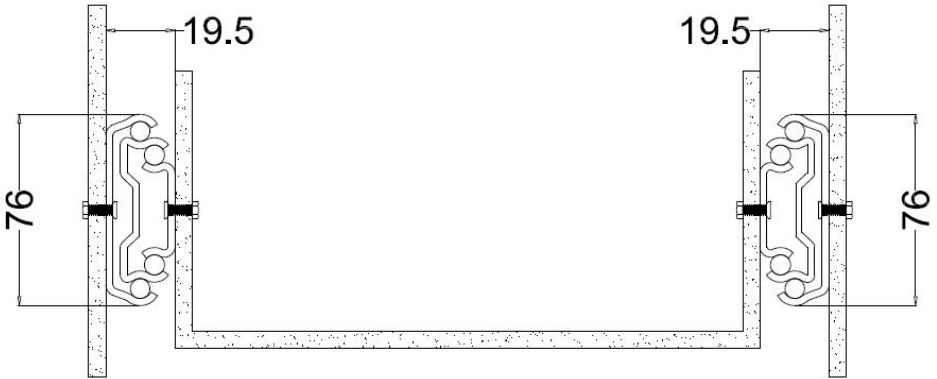

2. Install the outer rail.

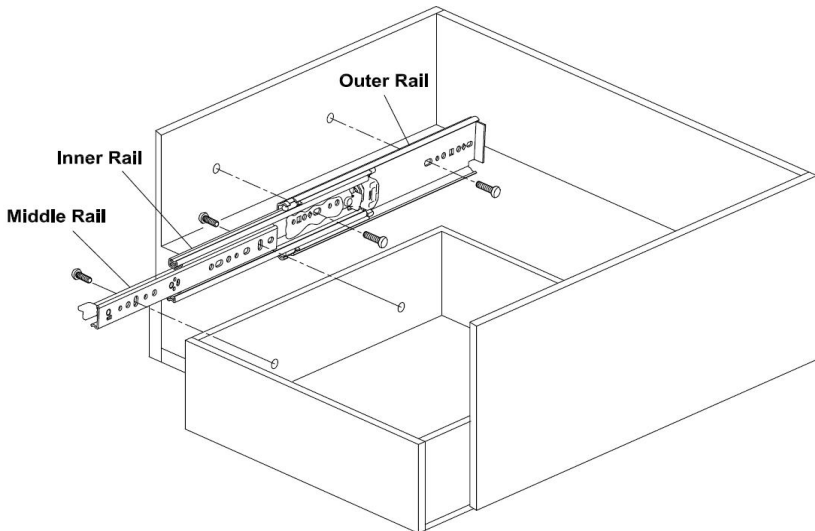

3. Install the drawer.

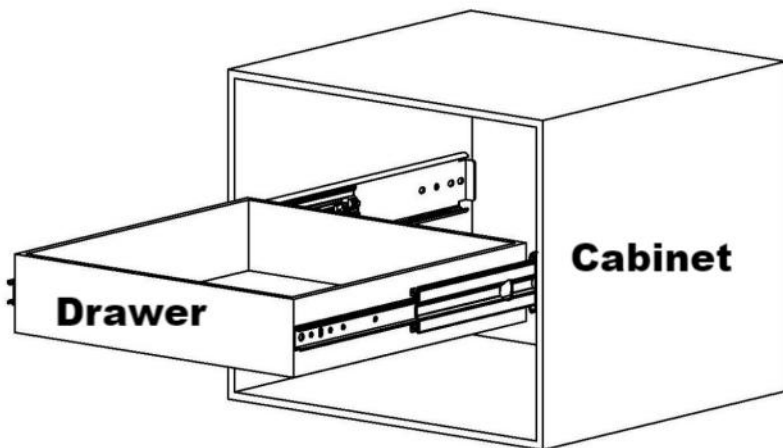

Press To Unlock

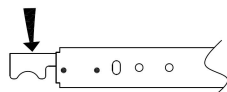

Installation Procedure(Method 2)

1. Pay attention to the installation space on both sides.(Units:mm)

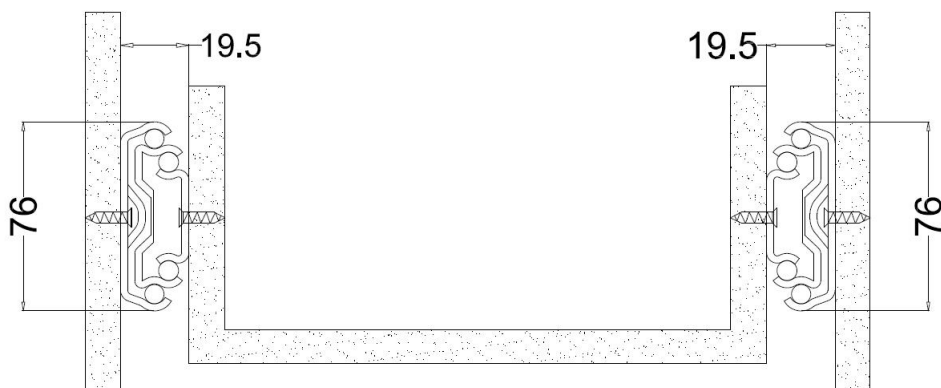

2.Install the outer rail.

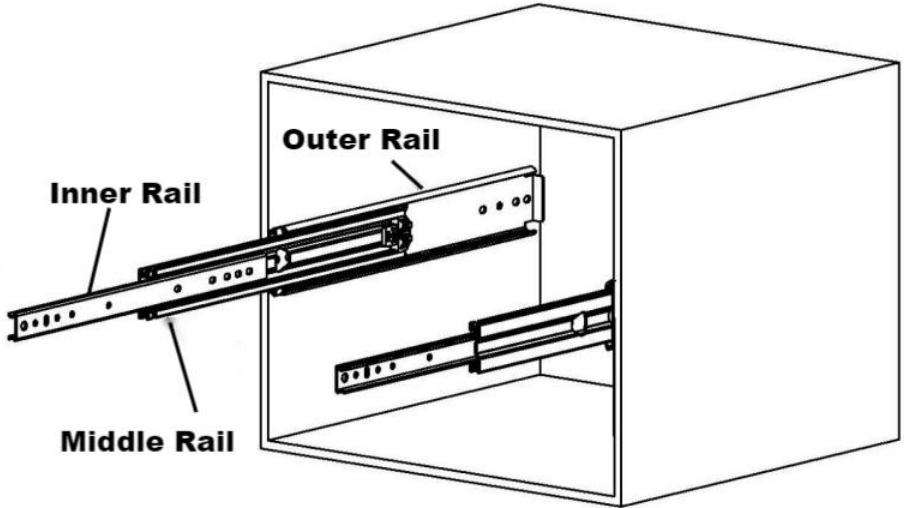

3. Install the drawer.

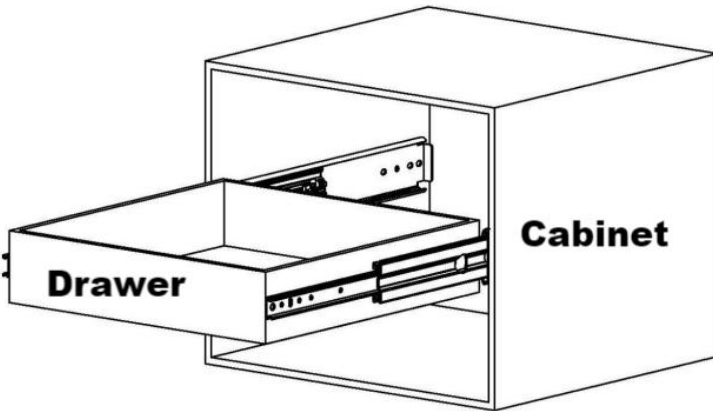

Press To Unlock

