

MH-SH-131



ASSEMBLY INSTRUCTIONS

Do not throw away the packaging material until the assembly is complete.
To protect the product, assemble this item on a soft surface such as a cardboard or a carpet.
While assembling the product, first tighten the bolts/screws up to 50%. Once all parts are in place, only then fully tighten the bolts/screws!

CARE INSTRUCTIONS

Wipe only with a soft & dry cloth.
To protect product, avoid the use of chemicals and household cleaners.
Any liquid spilled on the product should be cleaned up immediately with a damp cloth.

HARDWARE PROVIDED



A
JCBC
6 x 40mm
20X



B
WASHER
ø16 xø8mm
20X



C
LOCK WASHER
Ø8.5mm
20X



D
ALLEN KEY
1X

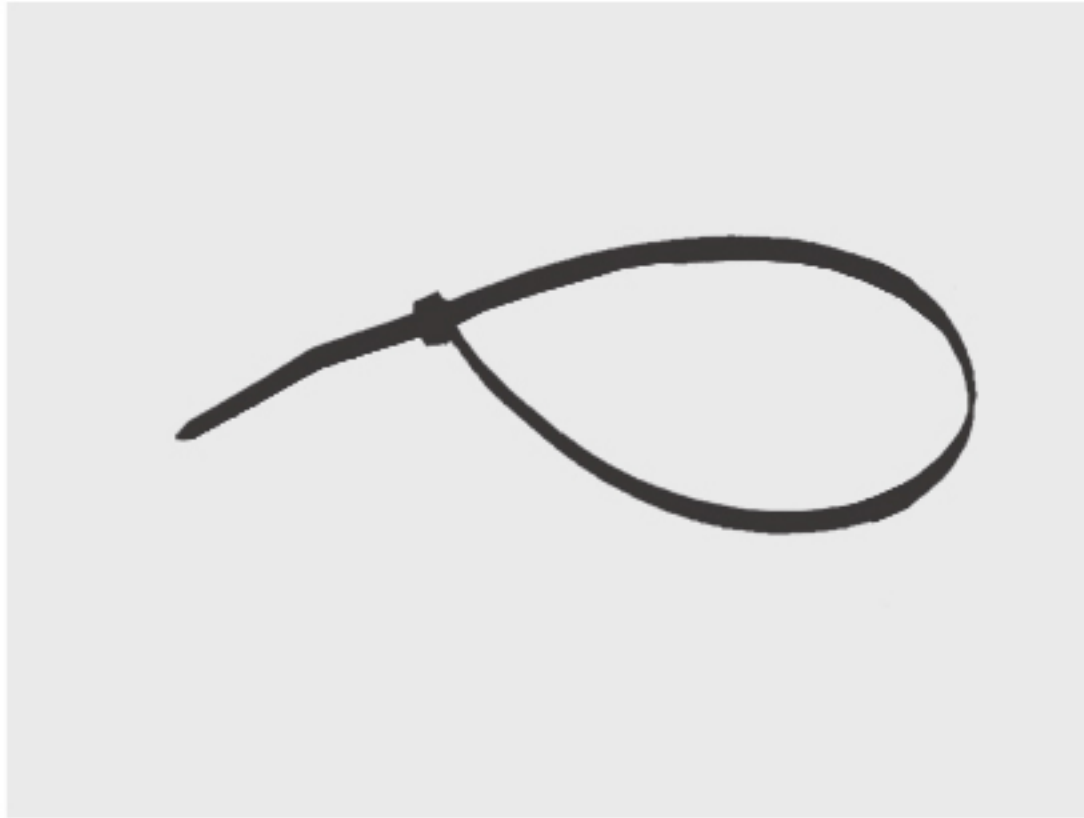

E
ZIP TIE
300mm
02X

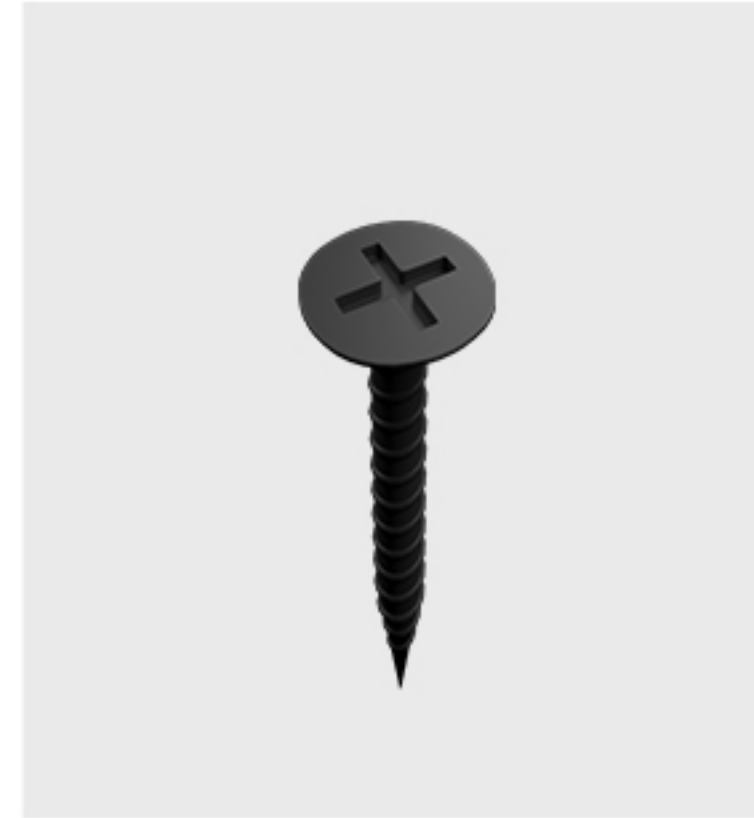

F
SCREW
25mm
4X

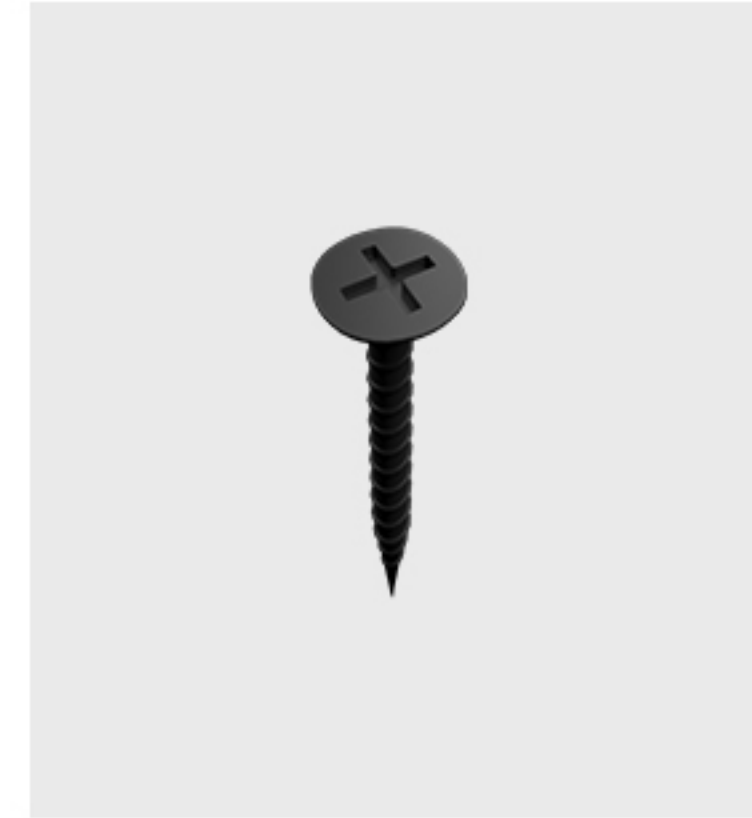

G
SCREW
13mm
4X



H
BRACKET
4X



I
PLASTIC ANCHOR
4X

PRODUCT PARTS



O

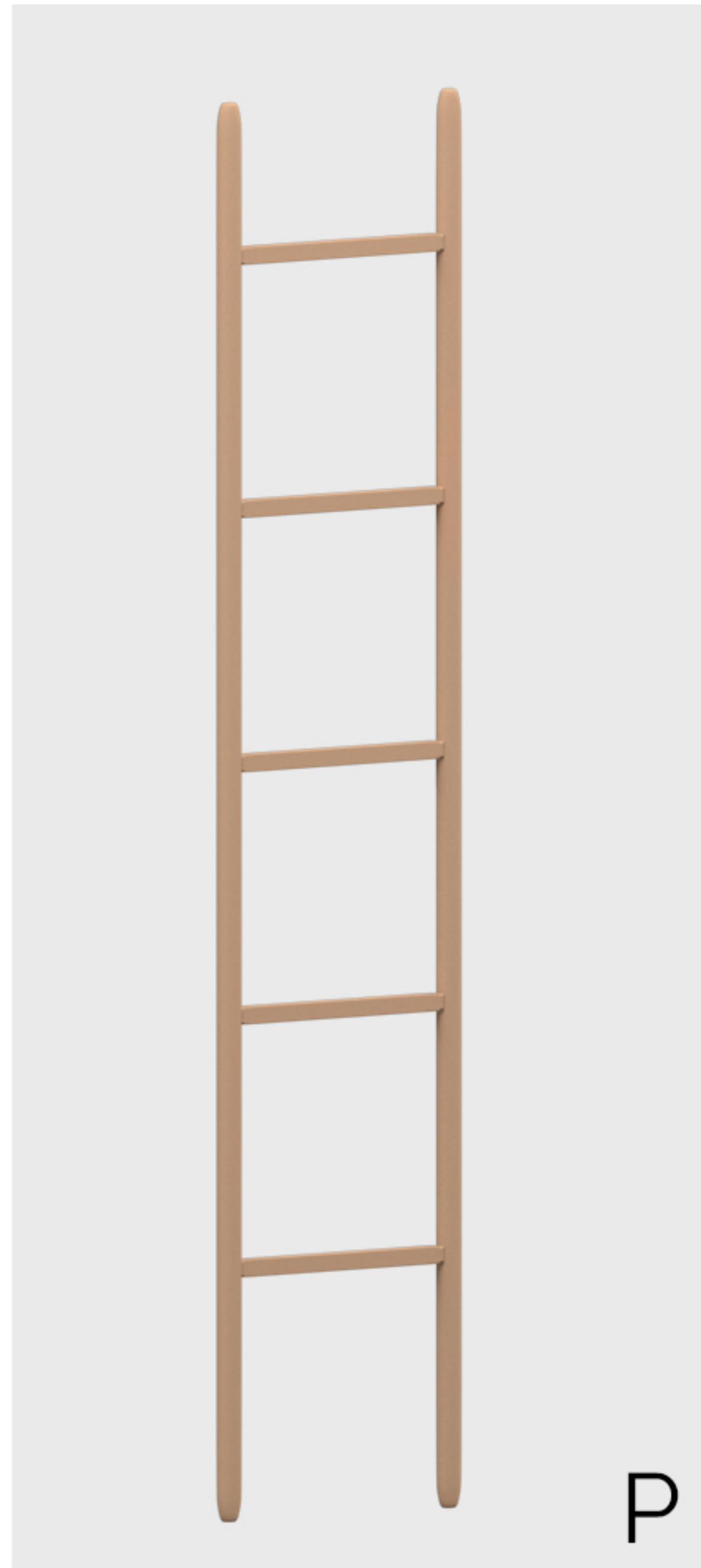

P

SUPPORTING FRAMES

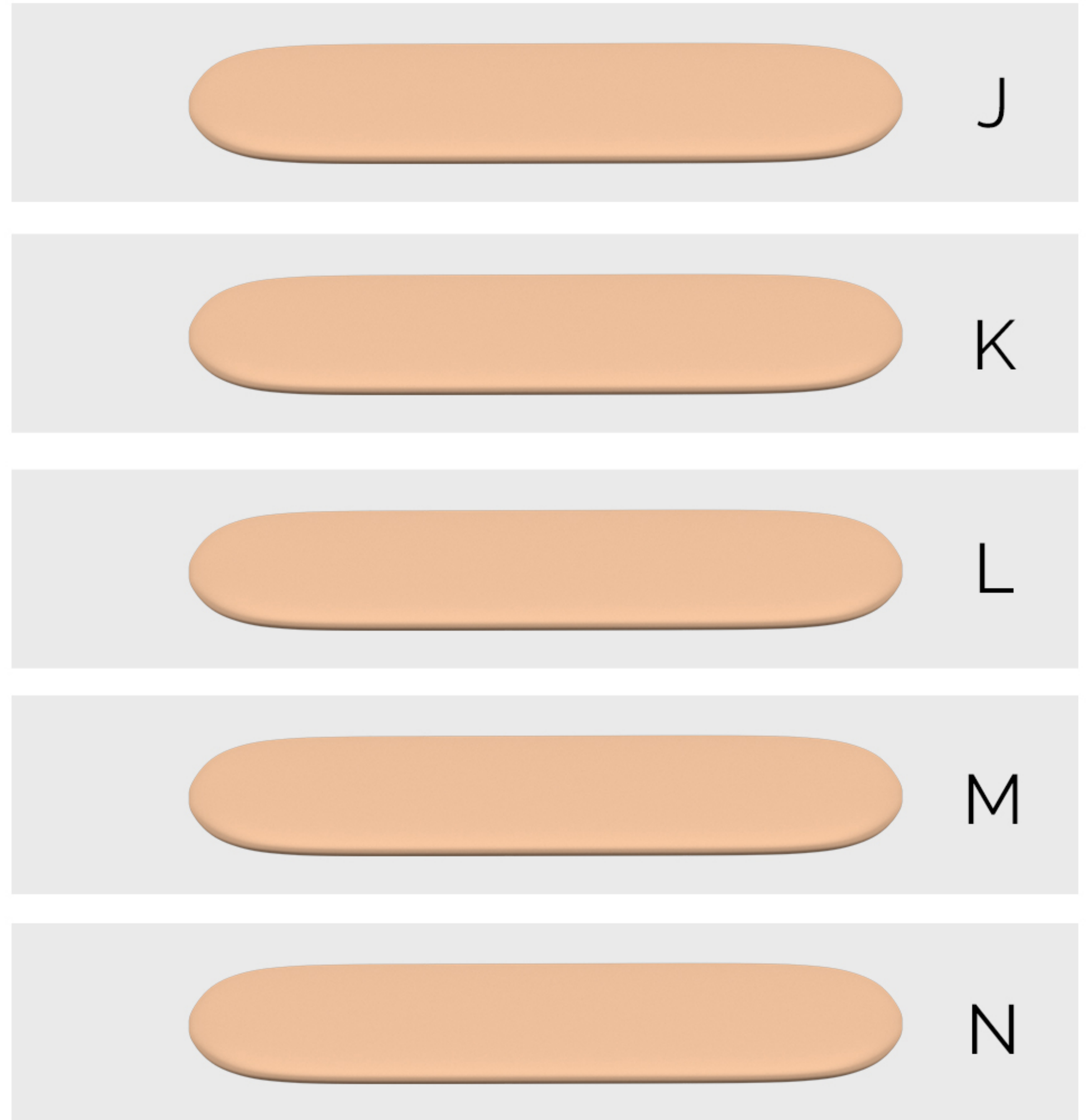

J

K

L

M

N

SHELVES

STEP 1

ASSEMBLY INSTRUCTIONS

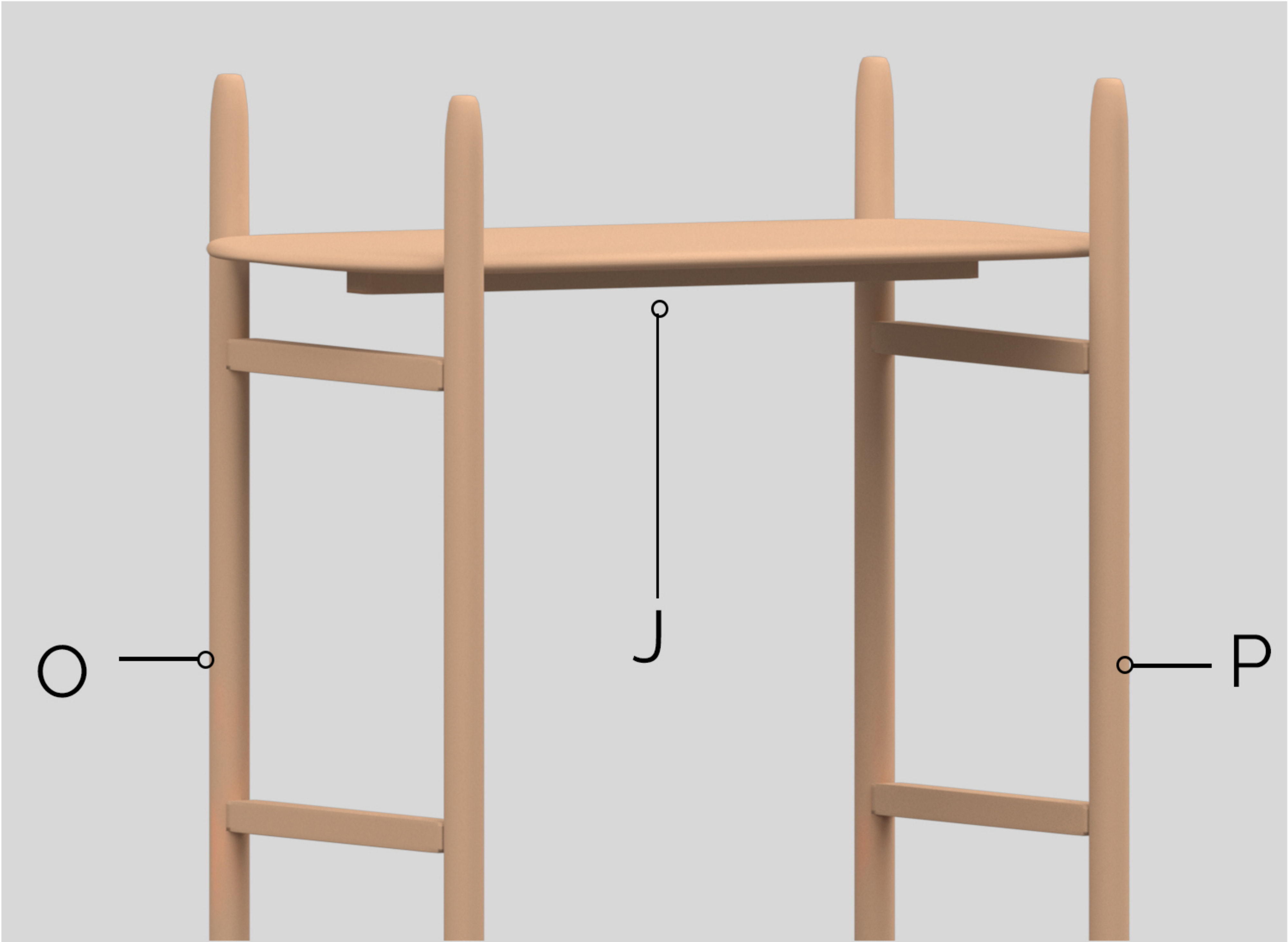

For further assembly, take a Shelf (J) and place it on the Support Frame (O) and (P).

STEP 2

Note - While assembling the product, first tighten the bolts/screws up to 50%. Once all parts are in place, only then fully tighten the bolts/screws!

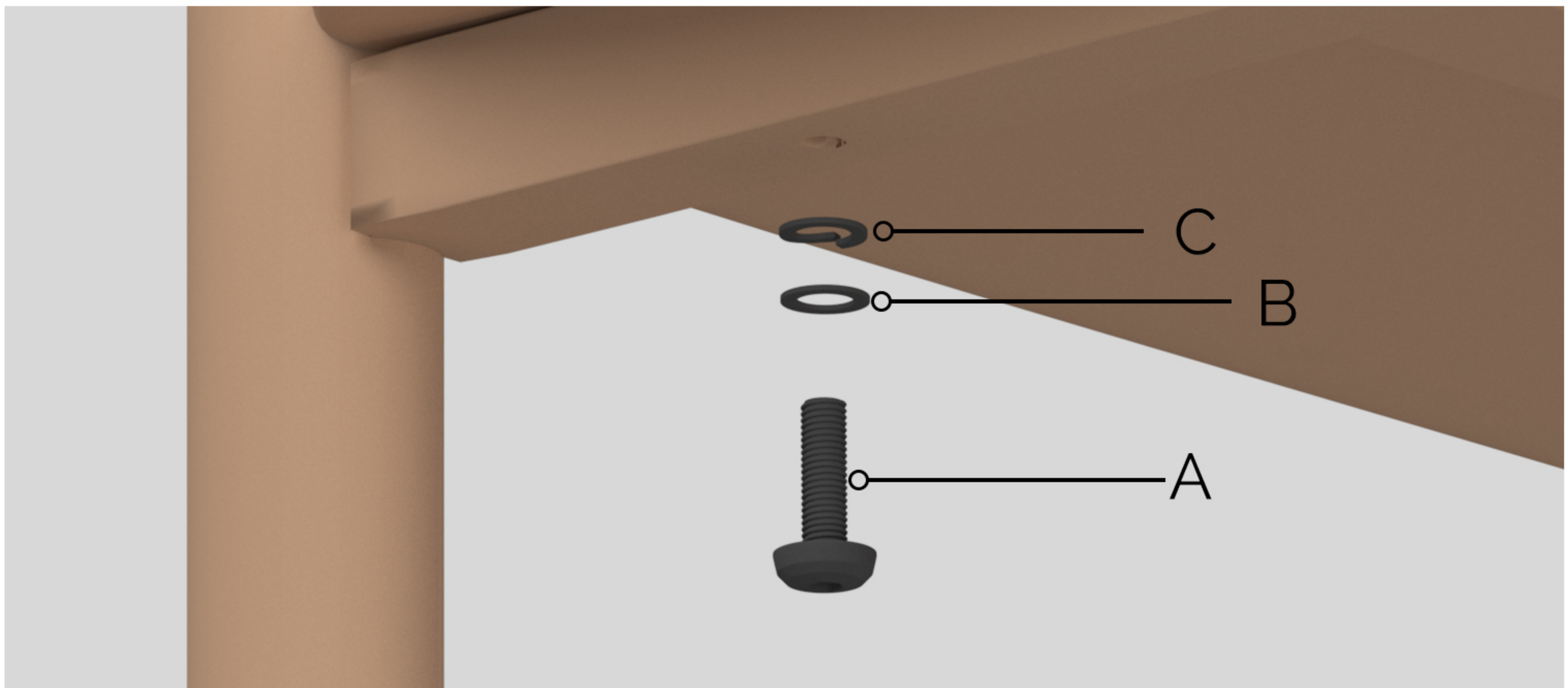

Once aligned, place the Lock Washer (C), Flat Washer (B) and bolts/screws (A) as shown in the image.

STEP 3

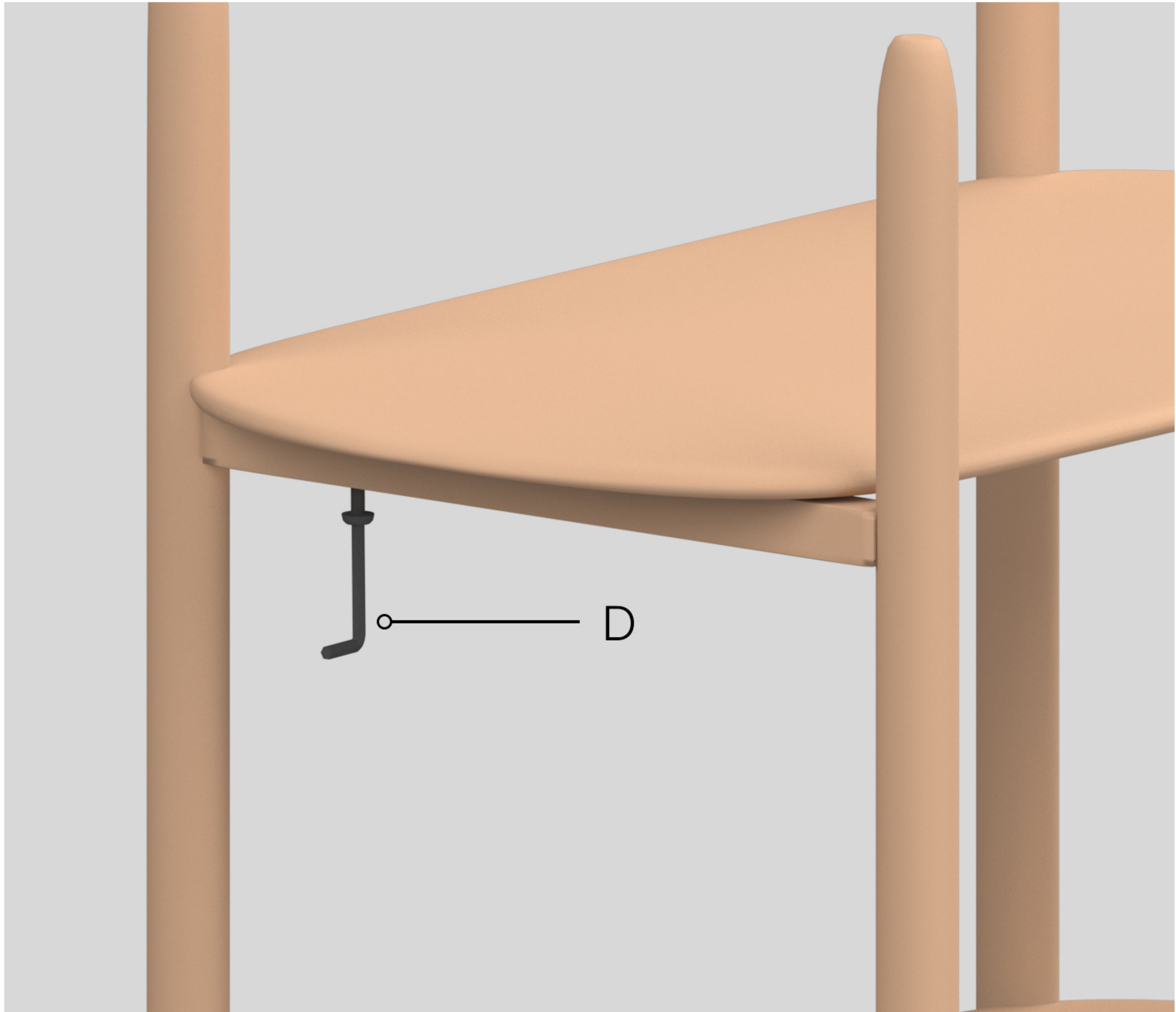

Tighten using the L-Key (D).

STEP 4



Repeat with the other Shelves (K,L,M and N).

STEP 5

INSTALLATION INSTRUCTIONS



Keep the assembled shelf adjacent to the wall.

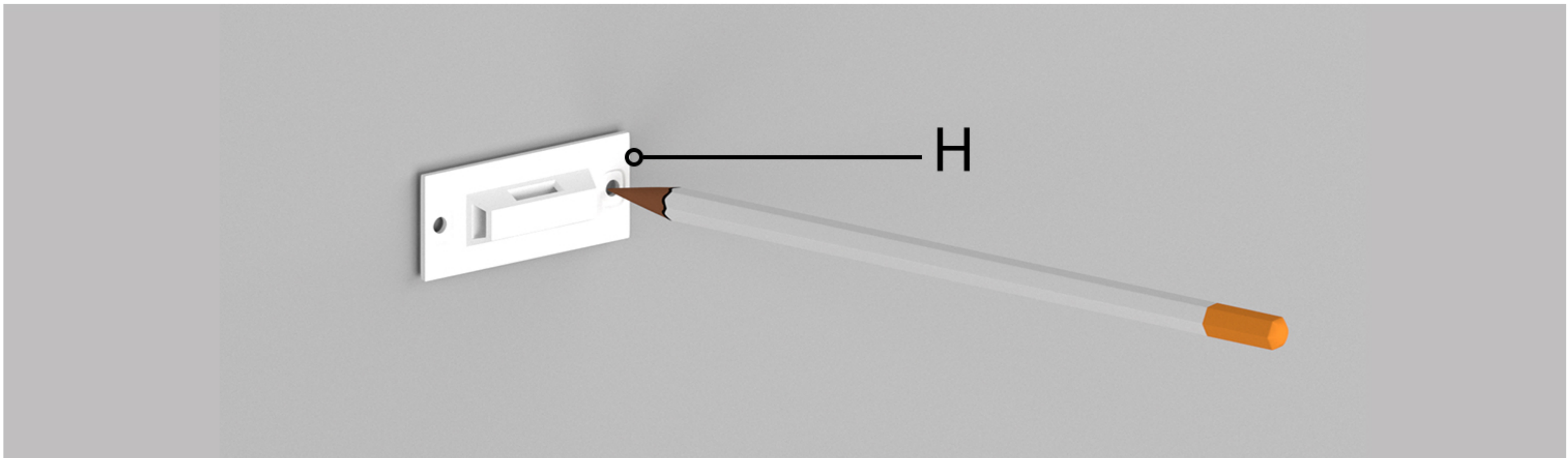

Make marks on the wall where the shelf needs to be attached.

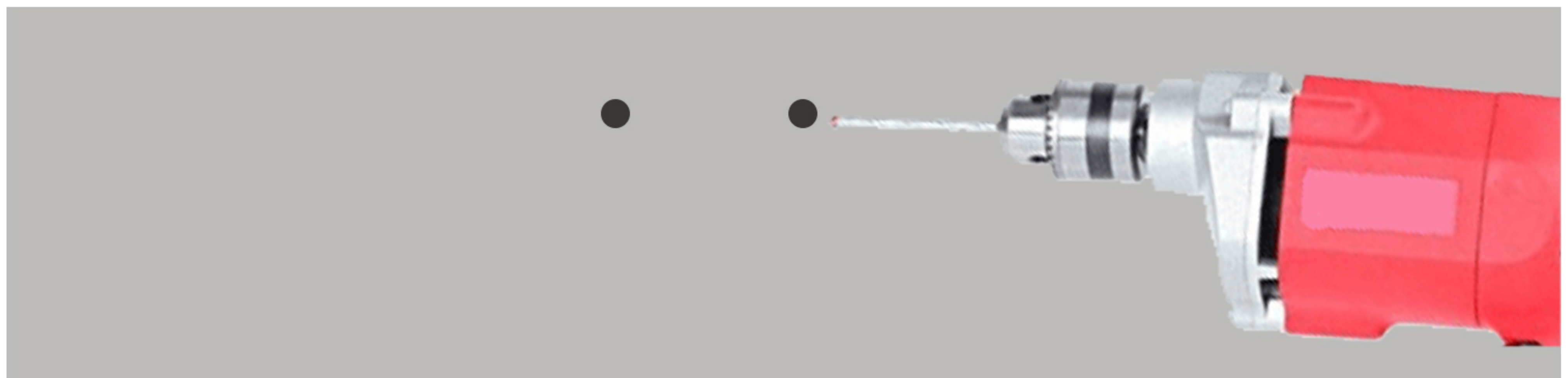

Drill holes in place of the marks.

STEP 6

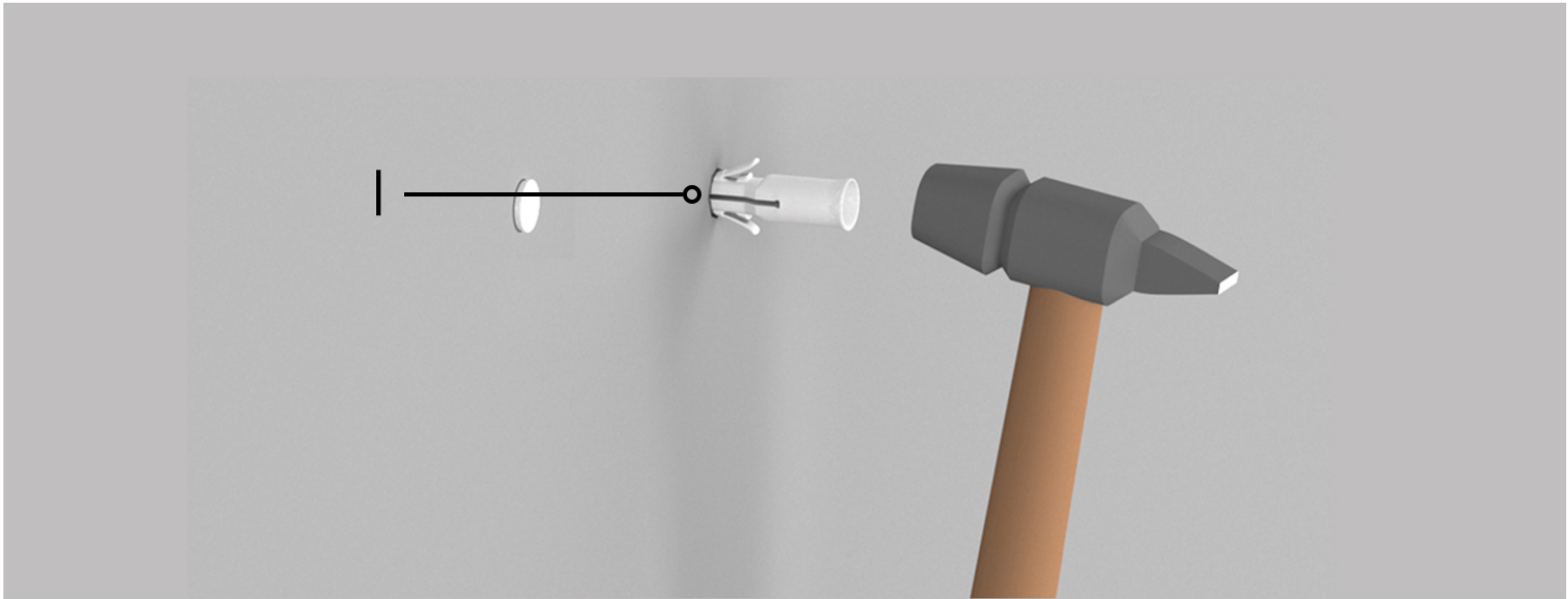

Insert Wall Plugs (I) in the holes.

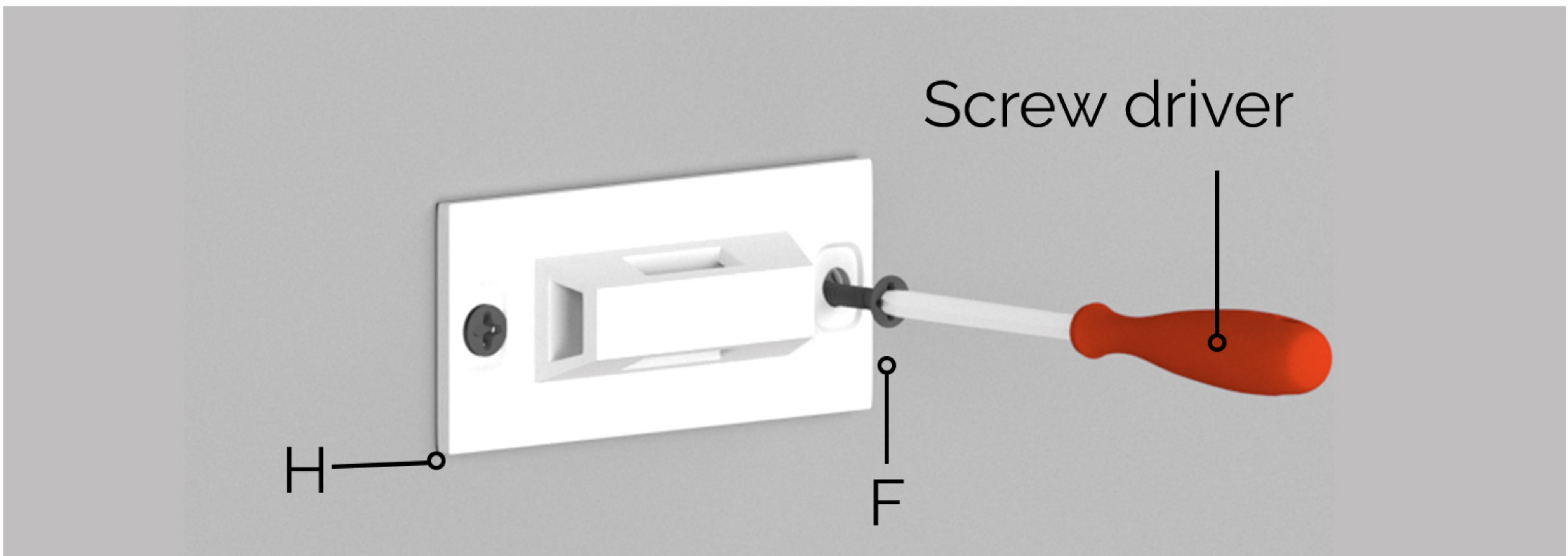

Now, place the Brackets (H) on top of it and insert bolts/screws (F). Tighten completely with the help of a Screwdriver.

STEP 7

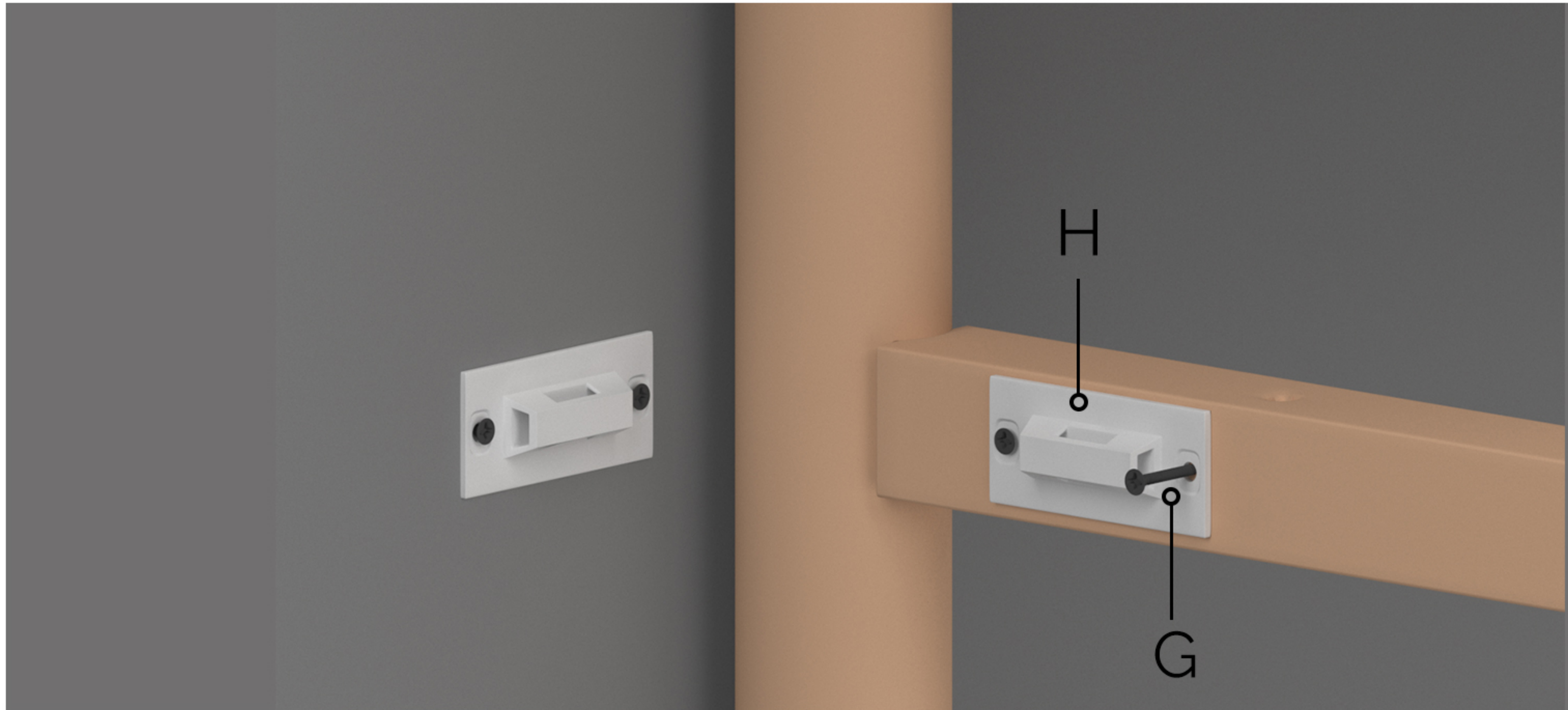

Insert screws (G) through the bracket (H) into the side of bookcase.

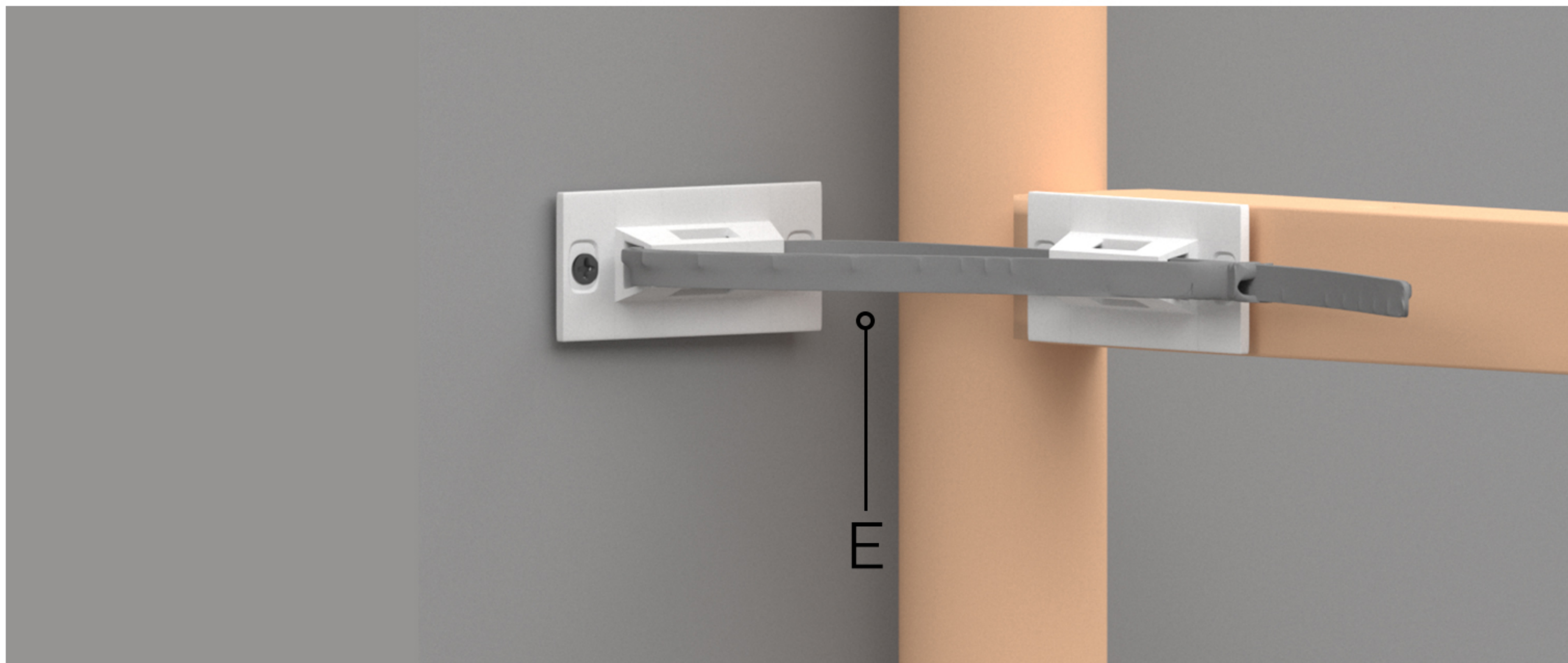

Attach one end of Lock Tie (E) into the bracket.



Your bookcase is now assembled and installed!