

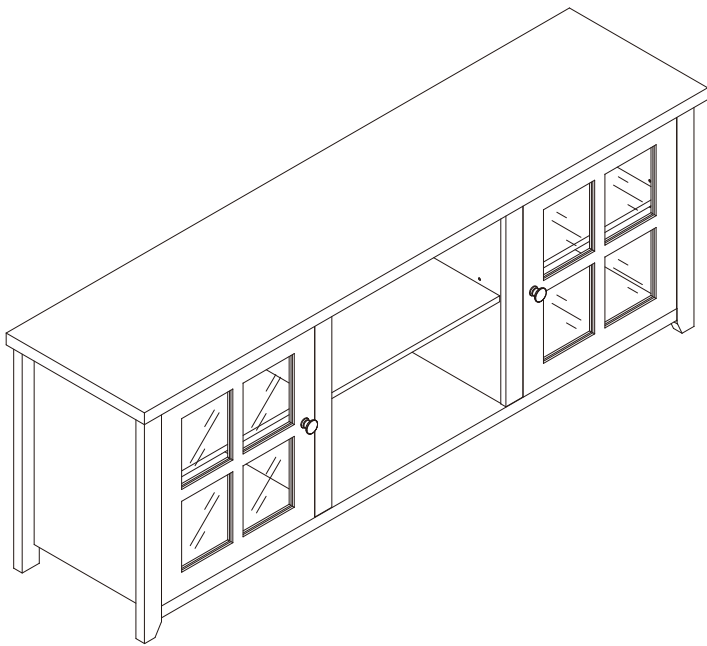



Thank you for your purchase!

Classic Four Pane Glass Door 65" TV Stand for up to 80" TVs

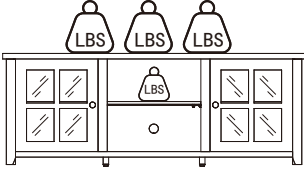

Assembly Time		60 min
Load Bearing		 200 LBS  30 LBS

ASSEMBLY INSTRUCTIONS

Before You Begin:

Please identify all component parts and hardware pieces required before you begin. Carefully remove all of the components from the packaging and set aside for assembly. Assemble on a soft surface to prevent scratching during assembly.

Caution:

Tighten all components securely before use. Failure to do so may result in personal injury. DO NOT use any sharp objects to open plastic wrapped components as damage to product or components may result.

Warning:

CHOKING HAZARD - Small Parts. Adult Assembly Required.

DO NOT ALLOW CHILDREN TO CLIMB ON FURNITURE

Serious or fatal injuries can occur from furniture tipping over. You must install Tipping Restraint Hardware (where included) to help prevent the unit from tipping and causing accidental injury, instability, death or damage. The tipping restraint is intended only as a safety measure, it is not a substitute for proper adult supervision.

To help prevent furniture from tipping over it must be permanently attached to the wall. Anti-Tip Safety Wall Straps suitable for the unit weight and wall materials (if not included) should be purchased and installed.

Online Assembly Instructions: <http://ftp.flashfurniture.com/AssemblyInstructions/GC-MBLK64-GY-GG.pdf>

Customer Service Email: CustomerExperience@belnick.com | Phone: 866-552-2810

GC-MBLK64-GY-GG/GC-MBLK64-WH-GG/GC-MBLK64-BR-GG

Have a Question/Concern?

Quality products and first-class customer service are the cornerstone of long-lasting consumer relationships. We strive toward excellence in all we do and want you to be completely satisfied with your purchase. Please contact our exceptional Customer Experience Agents at the email address or phone number shown below to assist you with any product questions or issues before requesting a return. We look forward to serving you in a friendly, efficient manner to resolve any issues you may have.

Customer Service Email: CustomerExperience@belnick.com

Customer Service Phone: 866-552-2810

Our Warranty Statement





This warranty covers manufacturing defects associated with your new product. The product is warranted from the original purchase date and to the original purchaser for normal usage, according to the below-referenced specifications and limitations.

- Non-moving metal parts are warranted for 5 years.
- Component parts including pneumatic cylinder, control mechanism, base and casters are warranted for 2 years.
- All other items are warranted for 1 year.

Normal usage means use in compliance with the restrictions and weight limits specified for the product. In the absence of product-specific restrictions and weight limits, normal usage means use for no more than forty hours per week by persons weighing 250 lbs. or less. Coverage terminates if the product is sold or otherwise transferred. Repairs made by parties other than Belnick also void this warranty.

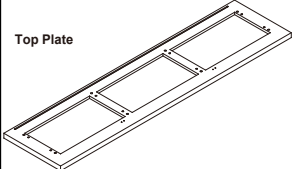
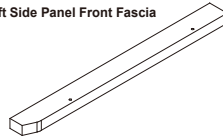
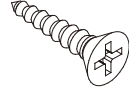
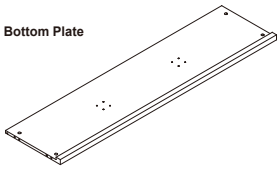
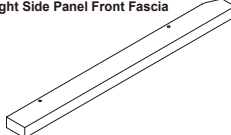
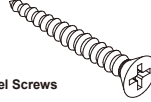
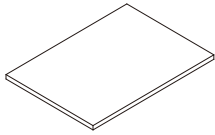
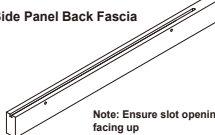
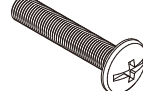
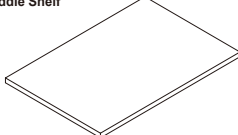
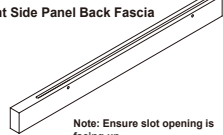
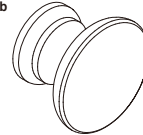
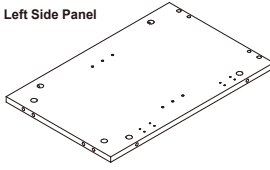
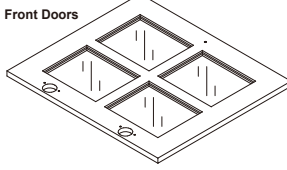
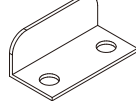
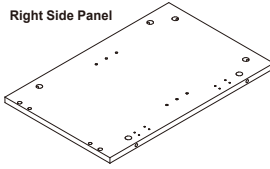
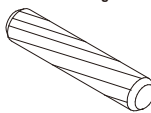
This warranty will not cover: (1) labor, freight, or damage from misuse, abuse, negligence, alteration, assembly, installation, attachments, accident, vandalism, acts of nature or any other event beyond the control of Belnick; (2) tearing, scratching, scuffing, or blemishing of leather or fabric; (3) cosmetic damage that may result from normal usage; (4) damage attributable to use by persons exceeding specified weight limits or commercial use exceeding forty hours per week; or (5) rust or other damage caused by exposure to moisture. The user assumes all risk of injury resulting from use of this product. Liability for incidental or consequential damage is excluded. Some states do not allow the exclusion or limitation of incidental or consequential damages, so the above limitation or exclusion may not apply to you.

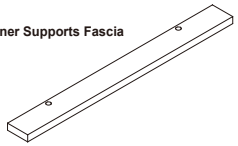
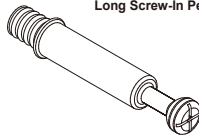
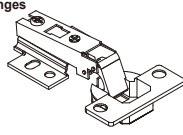
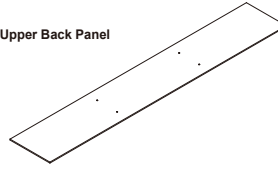
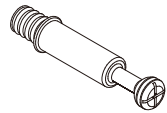
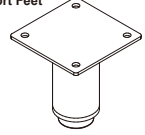
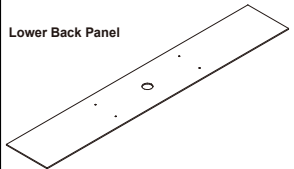
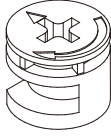
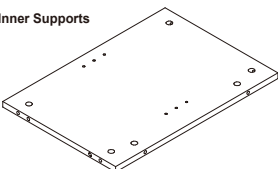
PARTS

(1)	Top Plate 	1	(11)	Left Side Panel Front Fascia 	1	F	3.5*14 Screws 	36+1
(2)	Bottom Plate 	1	(12)	Right Side Panel Front Fascia 	1	G	Back Panel Screws 	8+1
(3)	Left & Right Upper Shelves 	2	(13)	Left Side Panel Back Fascia  <small>Note: Ensure slot opening is facing up</small>	1	H	Door Knob Screws 	2
(4)	Middle Shelf 	1	(14)	Right Side Panel Back Fascia  <small>Note: Ensure slot opening is facing up</small>	1	I	Door Knob 	2
(5)	Left Side Panel 	1	(15)	Front Doors 	2	J	Door Strike Plates 	2
(6)	Right Side Panel 	1	A	Dowel Peg 	16+1	K	Shelf Holders 	12
(7)	Inner Supports Fascia 	2	B	Long Screw-In Peg 	20+1	L	Door Hinges 	4
(8)	Upper Back Panel 	1	C	Short Screw-In Peg 	8+1	M	Bottom Support Feet 	2
(9)	Lower Back Panel 	1	D	Cam Lock Connector 	28+1			
(10)	Inner Supports 	2	E	Cam Lock Connector Covers 	28+1			

STEP 1

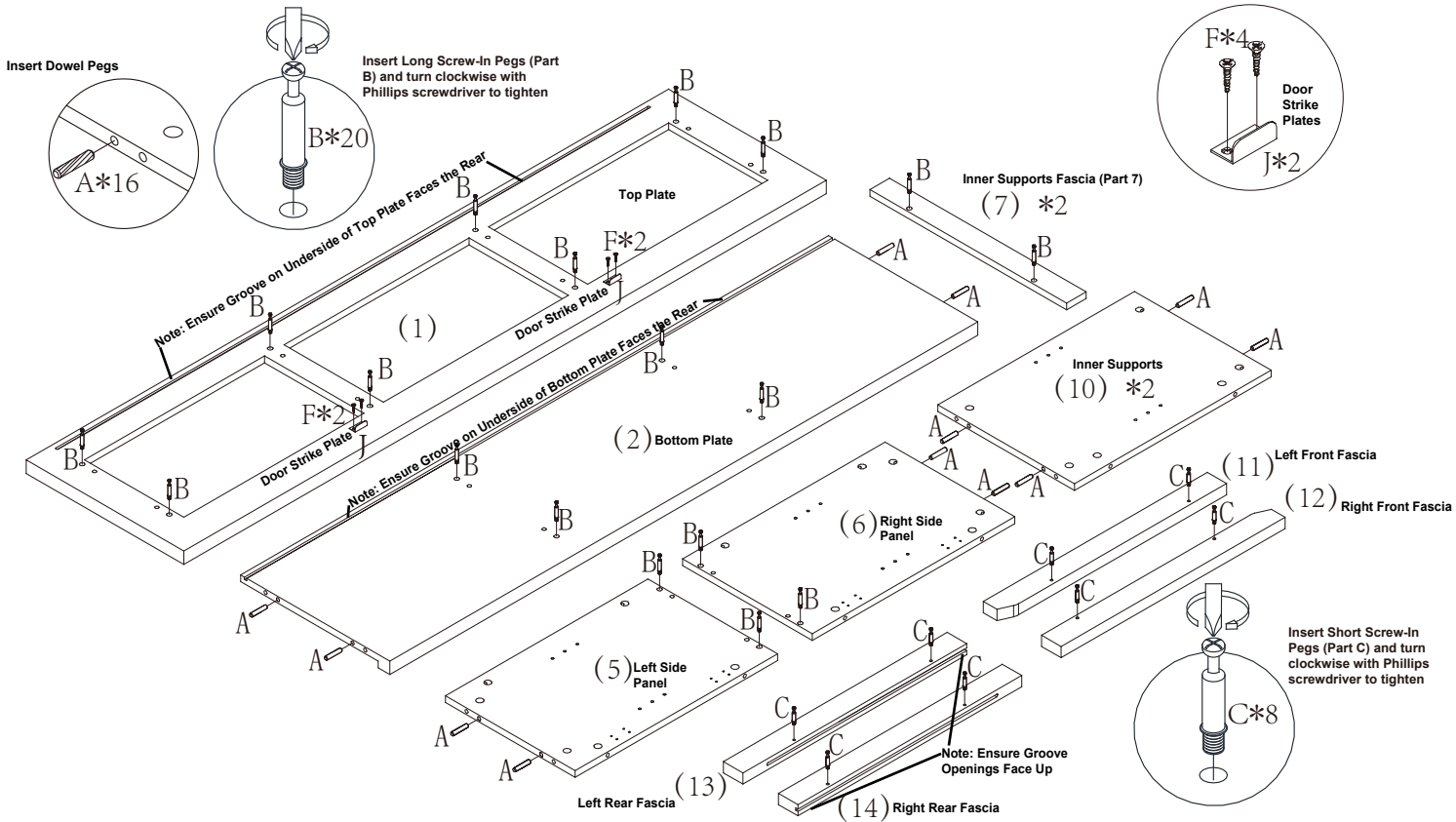

STEP 2

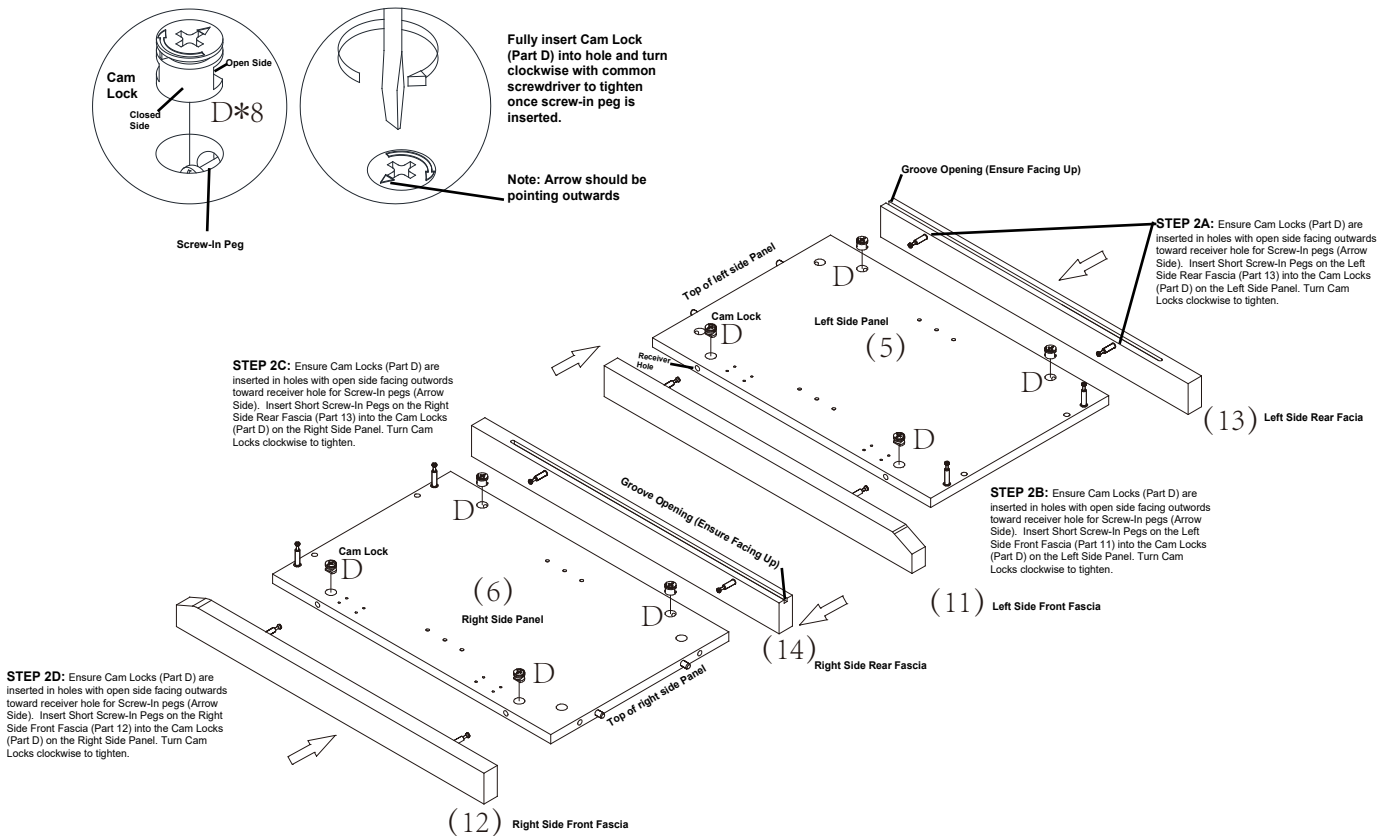

STEP 3

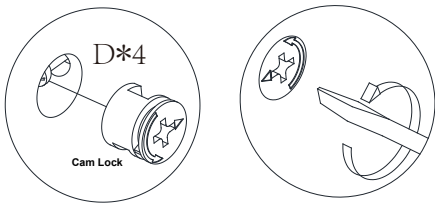

STEP 3: Ensure Cam Locks (Part D) are inserted in holes with open side facing outwards toward receiver hole for Screw-In pegs (Arrow Side). Insert Long Screw-In Pegs (Part B) at the bottoms of the Left Side Panel (Part 5) and Right Side Panel (Part 6) into the Bottom Plate (Part 2) and Turn Cam Locks clockwise to tighten. Ensure Dowel Pegs (Part A) are fully seated when tightened.

Note: Ensure Groove in Bottom Plate (Part 2) faces the rear and aligns with the grooves in the Left & Right Side Panels.

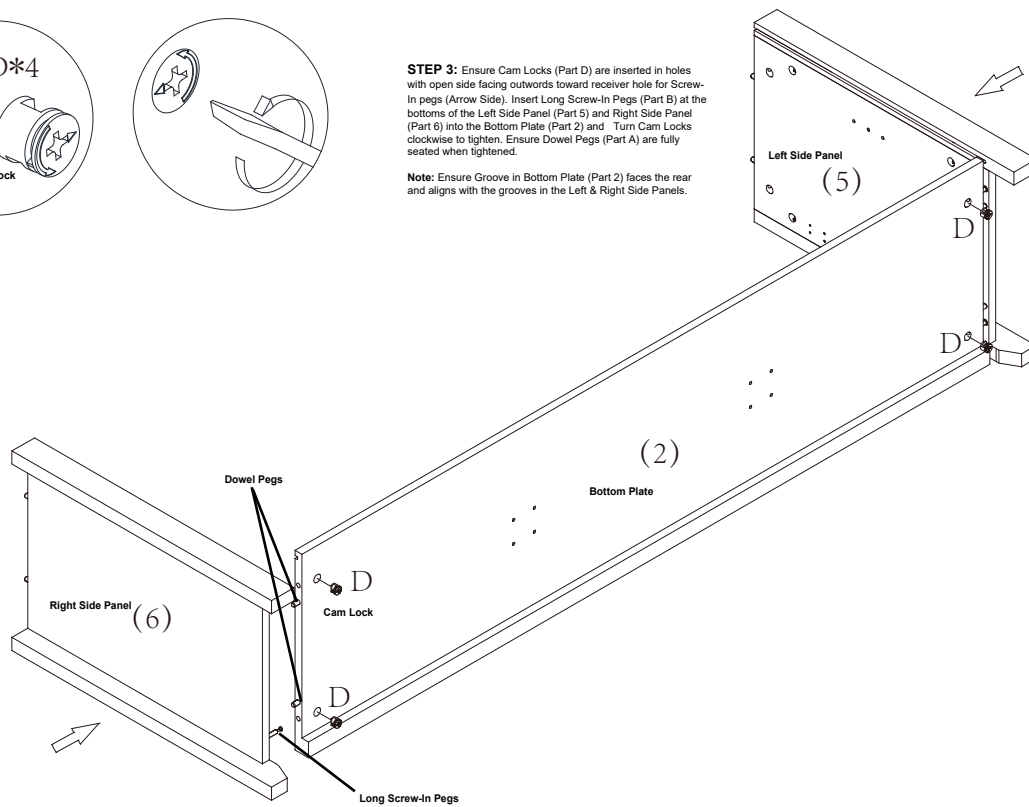

STEP 4

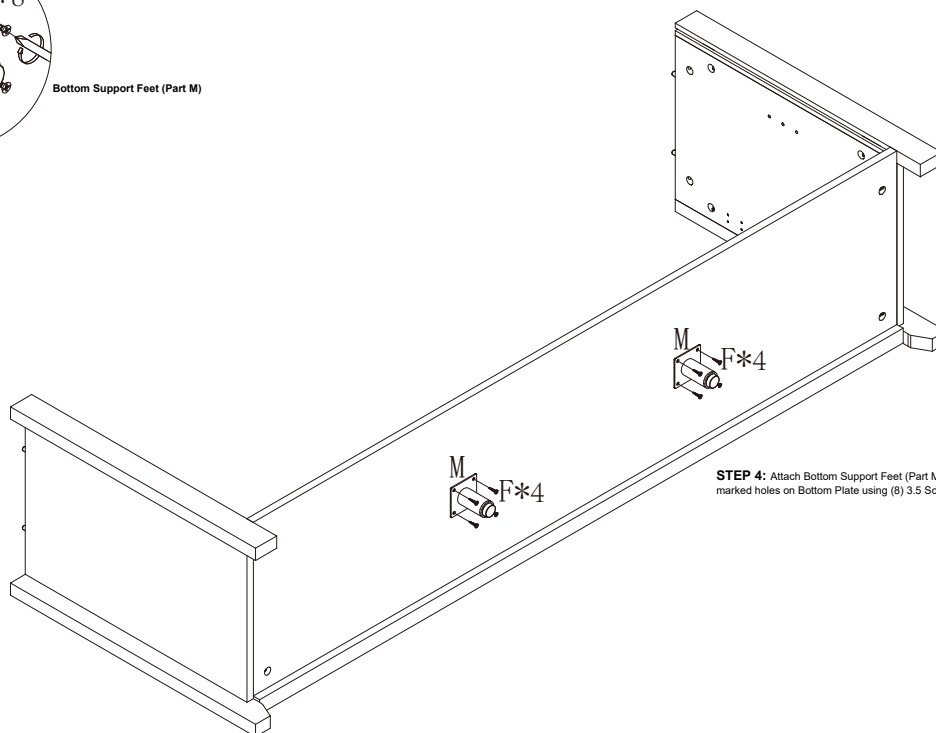
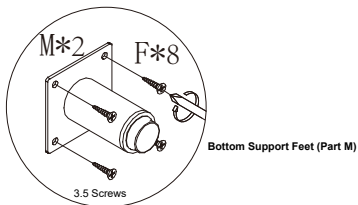

STEP 4: Attach Bottom Support Feet (Part M) onto pre-marked holes on Bottom Plate using (8) 3.5 Screws

STEP 5

STEP 5: Carefully place frame into an upright position. Place the Lower Rear Panel (Part 9) into the grooves on the Left & Right Side Panels and slide down into the groove on the Bottom Plate. Once seated place the Upper Rear Panel (Part 8) into the grooves on the Left & Right Side Panels and slide down until it meets the Lower Rear Panel.

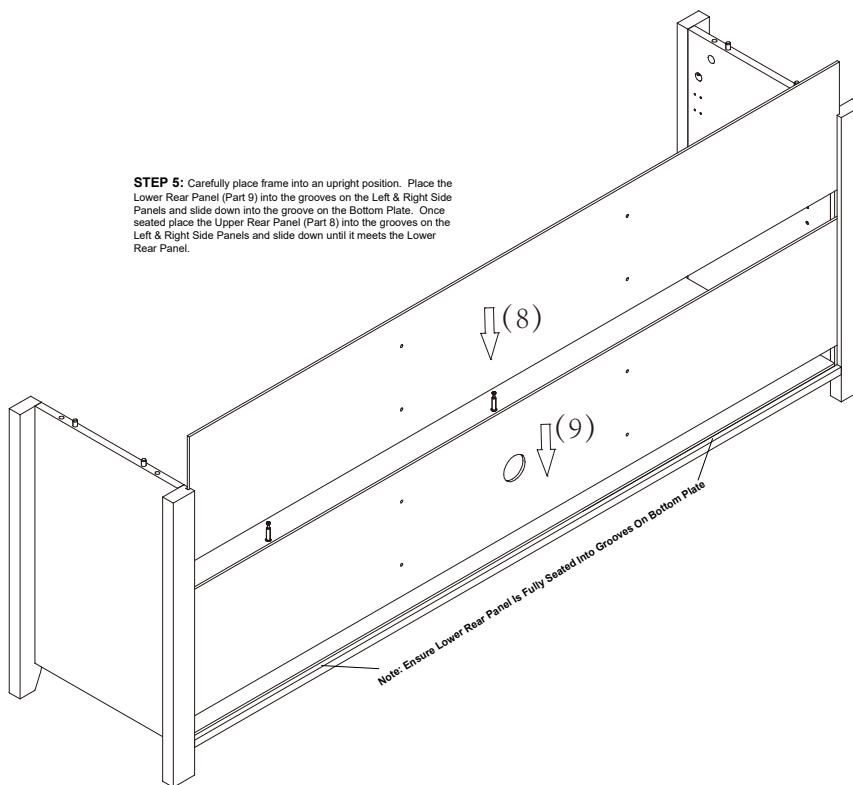

STEP 6

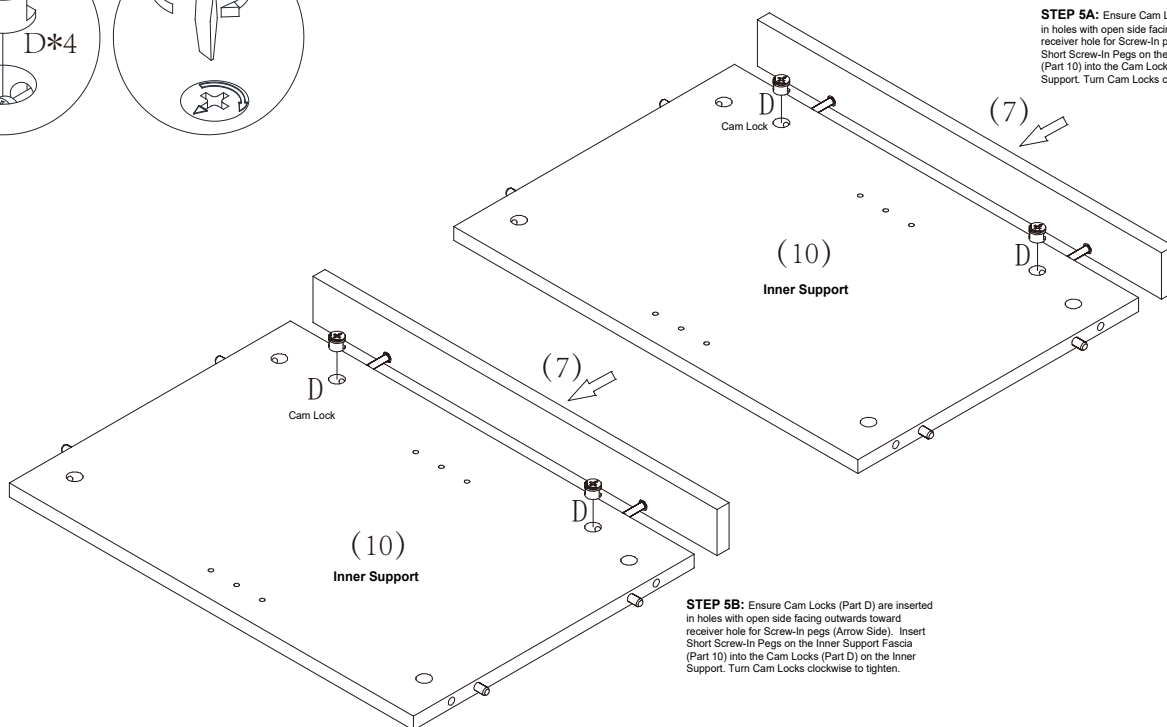
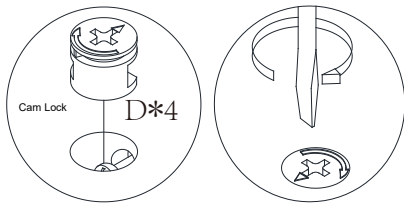

STEP 5A: Ensure Cam Locks (Part D) are inserted in holes with open side facing outwards toward receiver hole for Screw-In pegs (Arrow Side). Insert Short Screw-In Pegs on the Inner Support Fascia (Part 10) into the Cam Locks (Part D) on the Inner Support. Turn Cam Locks clockwise to tighten.

STEP 5B: Ensure Cam Locks (Part D) are inserted in holes with open side facing outwards toward receiver hole for Screw-In pegs (Arrow Side). Insert Short Screw-In Pegs on the Inner Support Fascia (Part 10) into the Cam Locks (Part D) on the Inner Support. Turn Cam Locks clockwise to tighten.



STEP 7

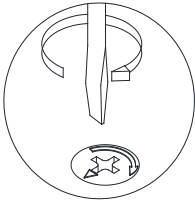

STEP 7: Ensure Cam Locks (Part D) are inserted in holes with open side facing outwards toward receiver hole for Screw-In pegs (Arrow Side). Slide Inner Supports onto Long Screw-In Pegs on the bottom plate ensuring that the Front Fascia are facing Left and Right (See Diagram). Turn the Cam Locks (Part D) clockwise to tighten.

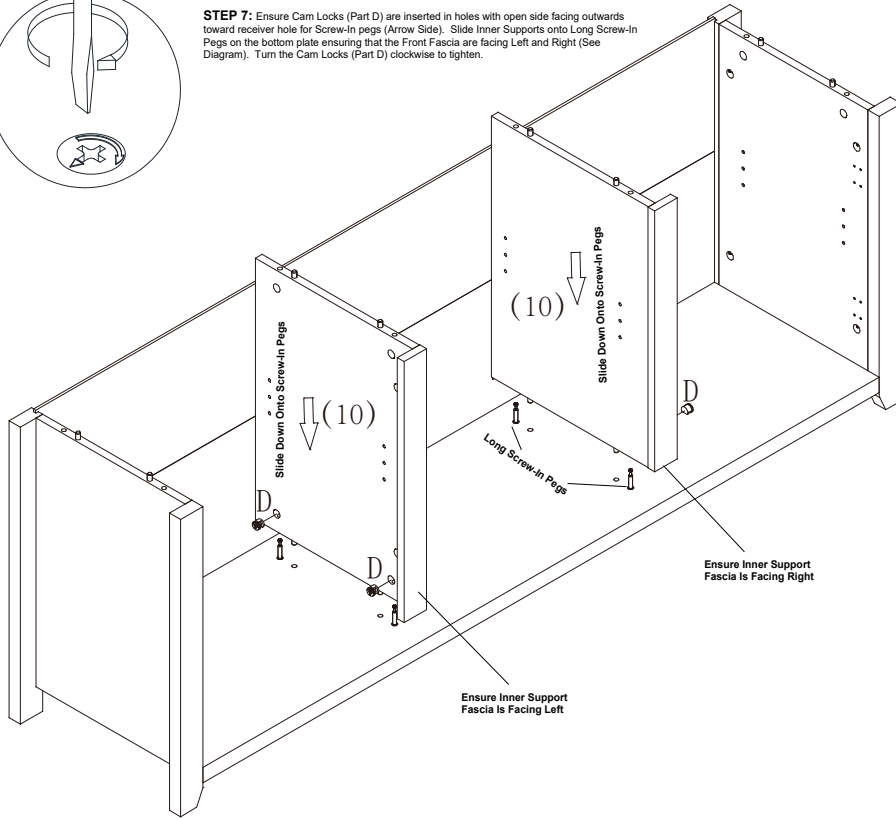

STEP 8

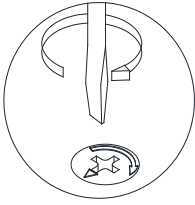

STEP 8A: Ensure Cam Locks (Part D) are inserted in holes with open side facing outwards toward receiver hole for Screw-In pegs (Arrow Side). Place Top Plate (Part 1) onto the assembled frame. Confirm that all Long Screw-In Pegs and Dowel Pegs that were preassembled in STEP 4 are seated correctly. Door Strike Plates should be facing the front and the groove on the underside of the Top Plate should be seated completely on the Upper Back Panel. Turn the Cam Locks (Part D) clockwise to tighten.

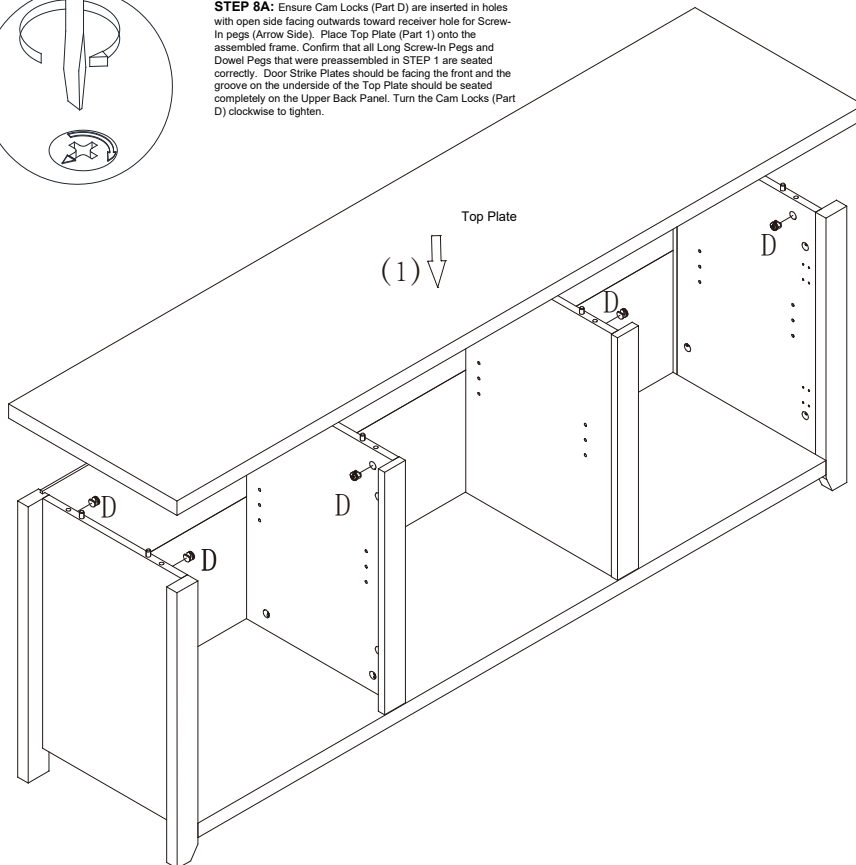
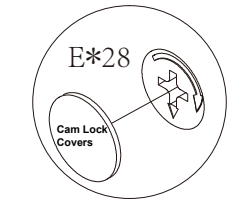

STEP 8B: Cover all Cam Locks with Cam Lock Covers (Part E)

STEP 9

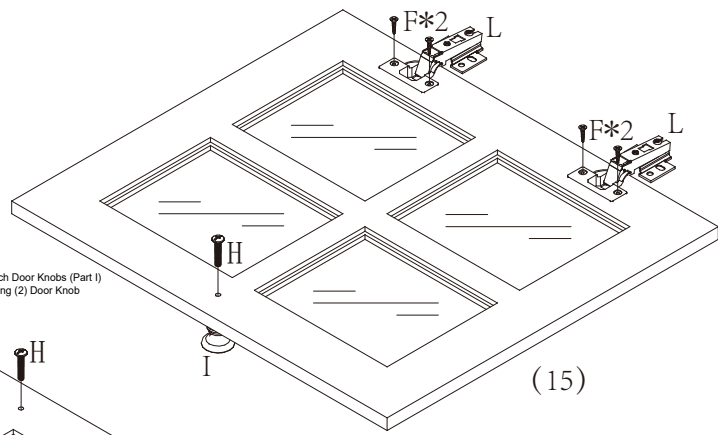
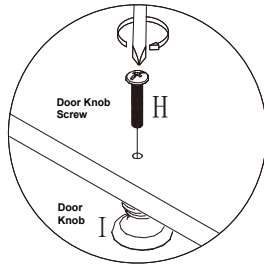
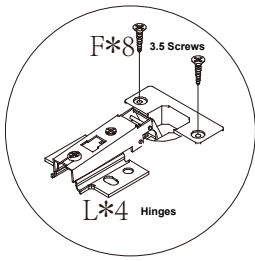

STEP 9B: Attach Door Knobs (Part I) to Front Doors using (2) Door Knob Screws (Part H)

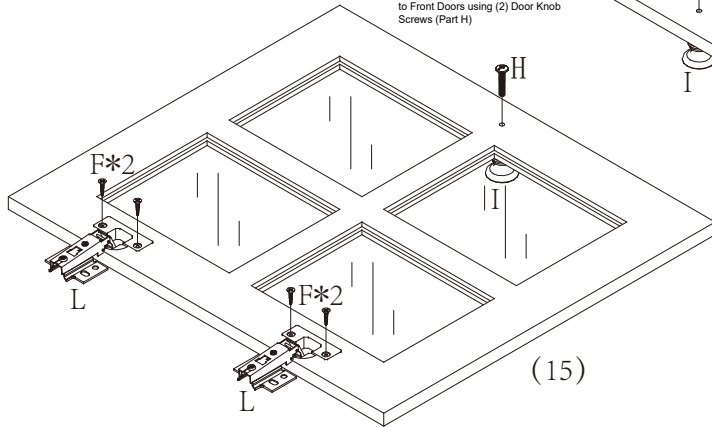

STEP 9A: Attach Hinges (Part L) to the inside of the Front Doors (Part 15) using (8) 3.5 Screws

STEP 10

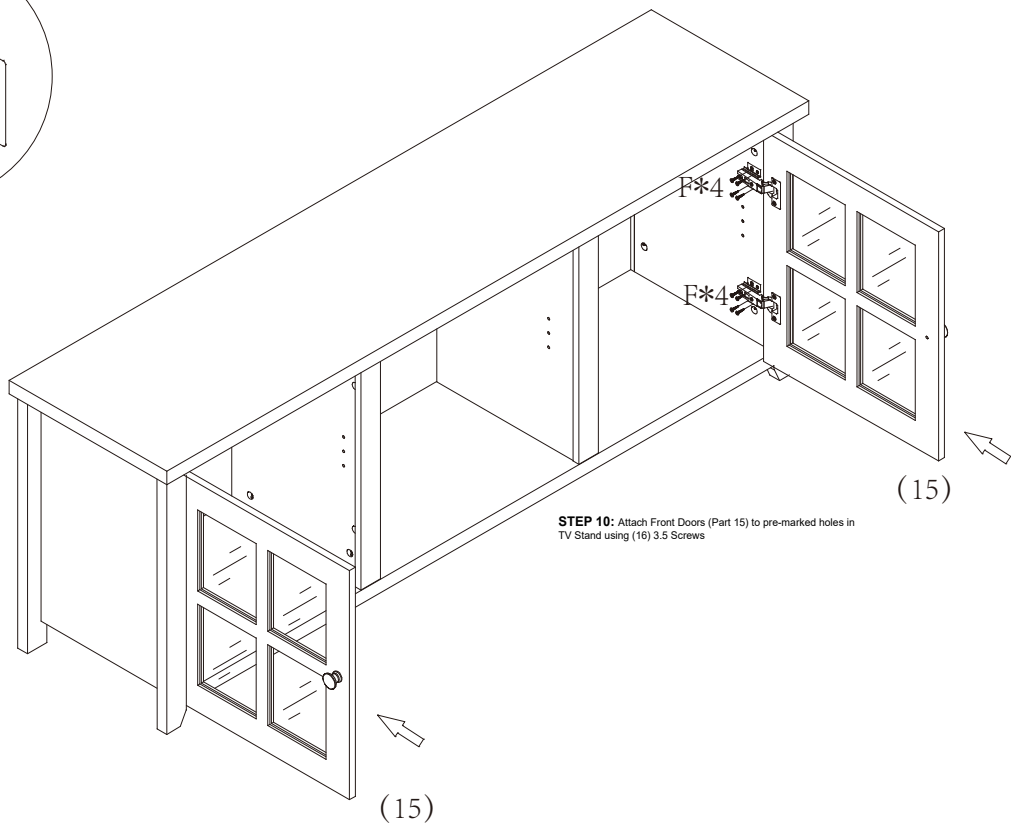
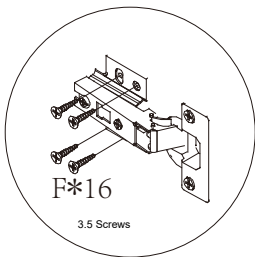

STEP 10: Attach Front Doors (Part 15) to pre-marked holes in TV Stand using (16) 3.5 Screws



STEP 11

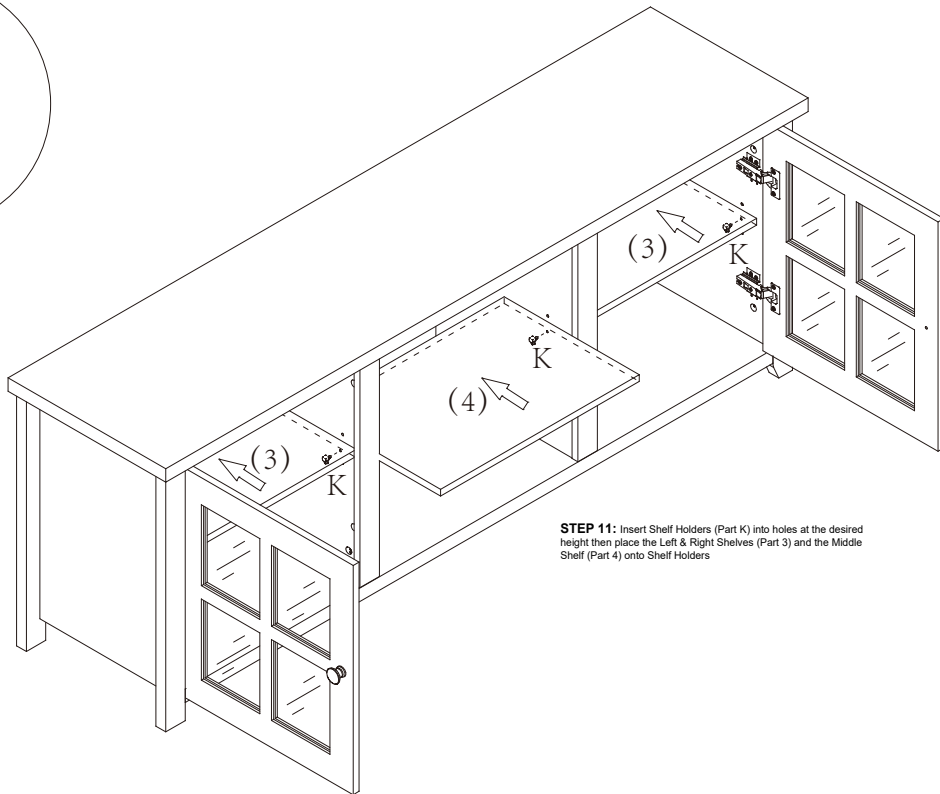
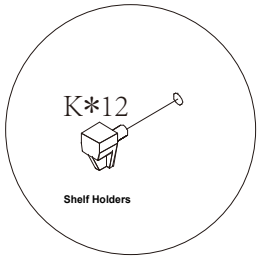

STEP 11: Insert Shelf Holders (Part K) into holes at the desired height then place the Left & Right Shelves (Part 3) and the Middle Shelf (Part 4) onto Shelf Holders

STEP 12

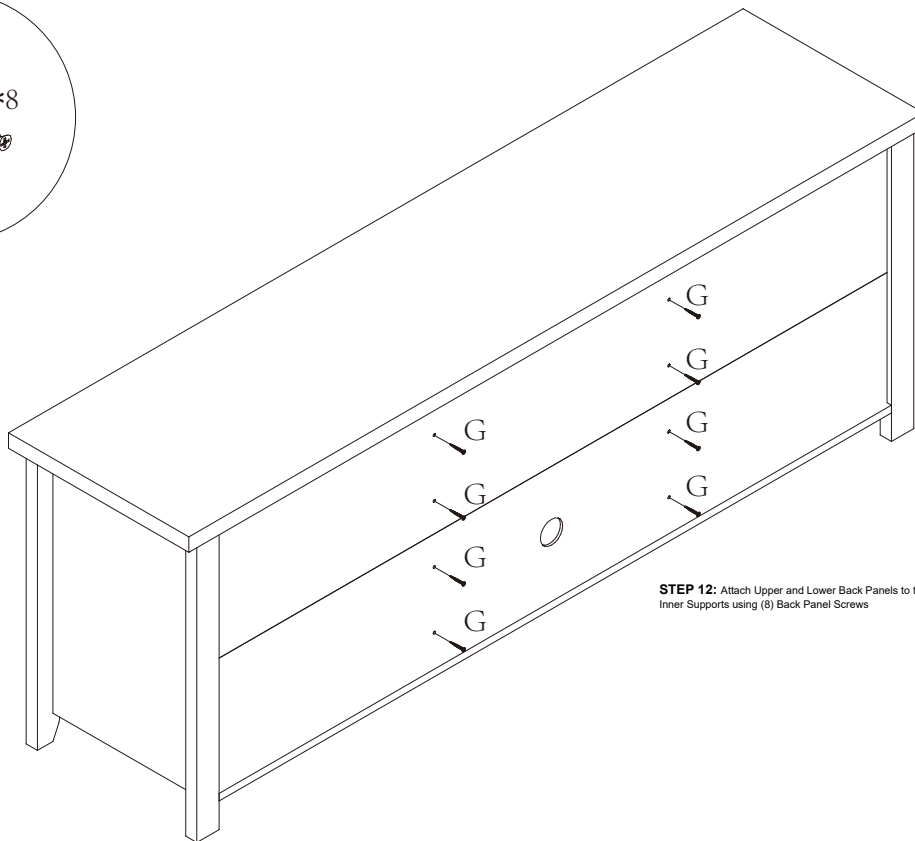
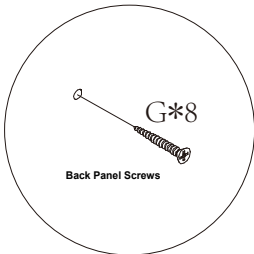

STEP 12: Attach Upper and Lower Back Panels to the Inner Supports using (8) Back Panel Screws

