

ASSEMBLY INSTRUCTIONS

HYNS-002

HYNS-002HS

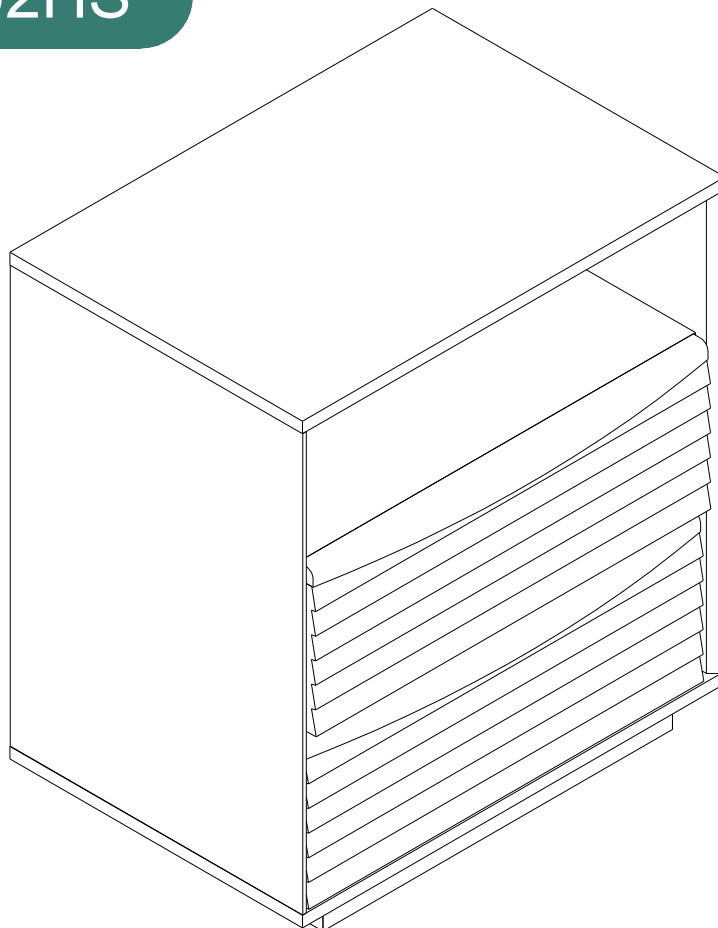

Notice:

1. Follow the installation instructions. Please confirm all accessories are preset before installation.
2. Do not fully tighten the screws during initial assembly. Fully tighten screws only once all pieces which are correctly assembled.
3. If you encounter any problems during installation, please contact our customer service.
4. Please unbox the item from the side with an open-label and put a carpet on the floor to avoid scratching it.

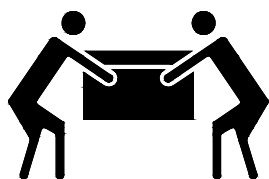

Recommended installers:2

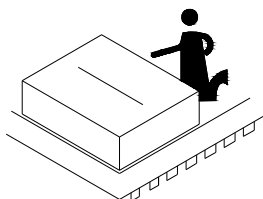

Put a carpet on the floor
before unpacking

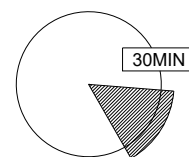

Estimate installation time:
30minutes

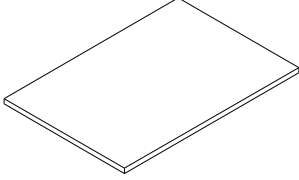
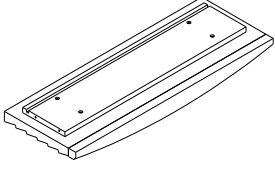
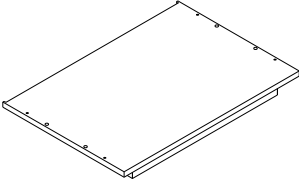
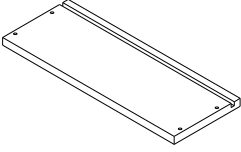
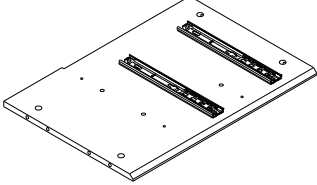
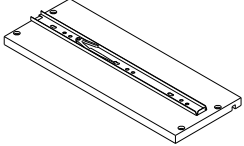
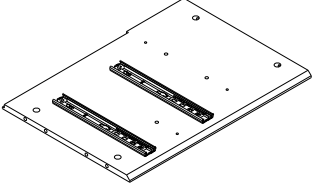
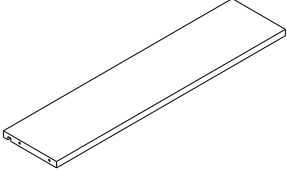
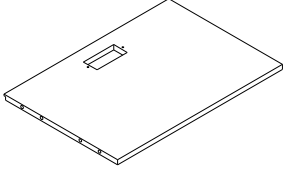
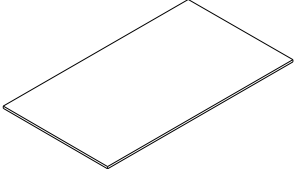
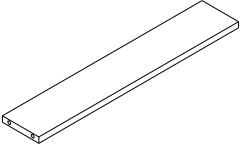
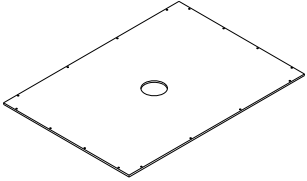

ASSEMBLY INSTRUCTIONS

PART LIST

Item no.	Reference Image	Qty	Item no.	Reference Image	Qty
(A)		X1	(G)		X2
(B)		X1	(H)		X2
(C)		X1	(I)		X2
(D)		X1	(J)		X2
(E)		X1	(K)		X2
(F)		X2	(L)		X1

ASSEMBLY INSTRUCTIONS

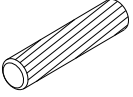
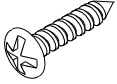
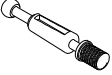
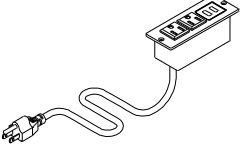
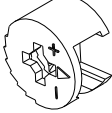
HARDWARE LIST

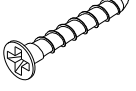
Item no.	Reference Image	Qty	Item no.	Reference Image	Qty
1	 Ø8*30mm	X14+1	5	 Ø3*15mm	X16+1
2		X14+1	6		X1
3		X14+1	7	 Ø3*15mm	X2
4	 Ø3.5*30mm	X16+1			

ASSEMBLY INSTRUCTIONS

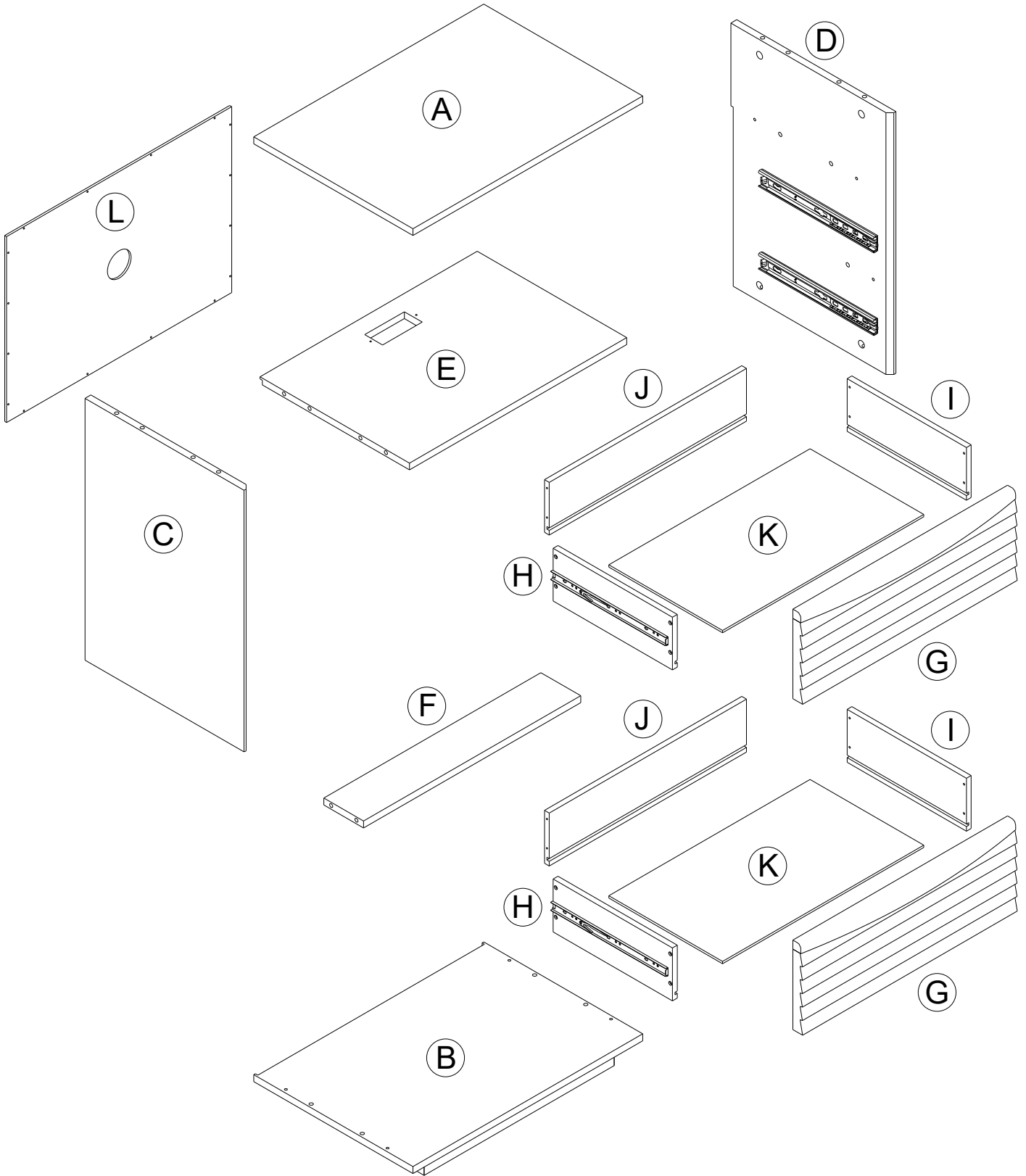

ASSEMBLY INSTRUCTIONS

1

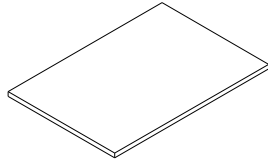

(A) 1PC

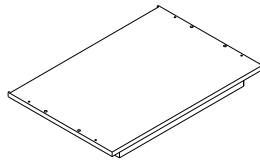

(B) 1PC



(2) 8PCS

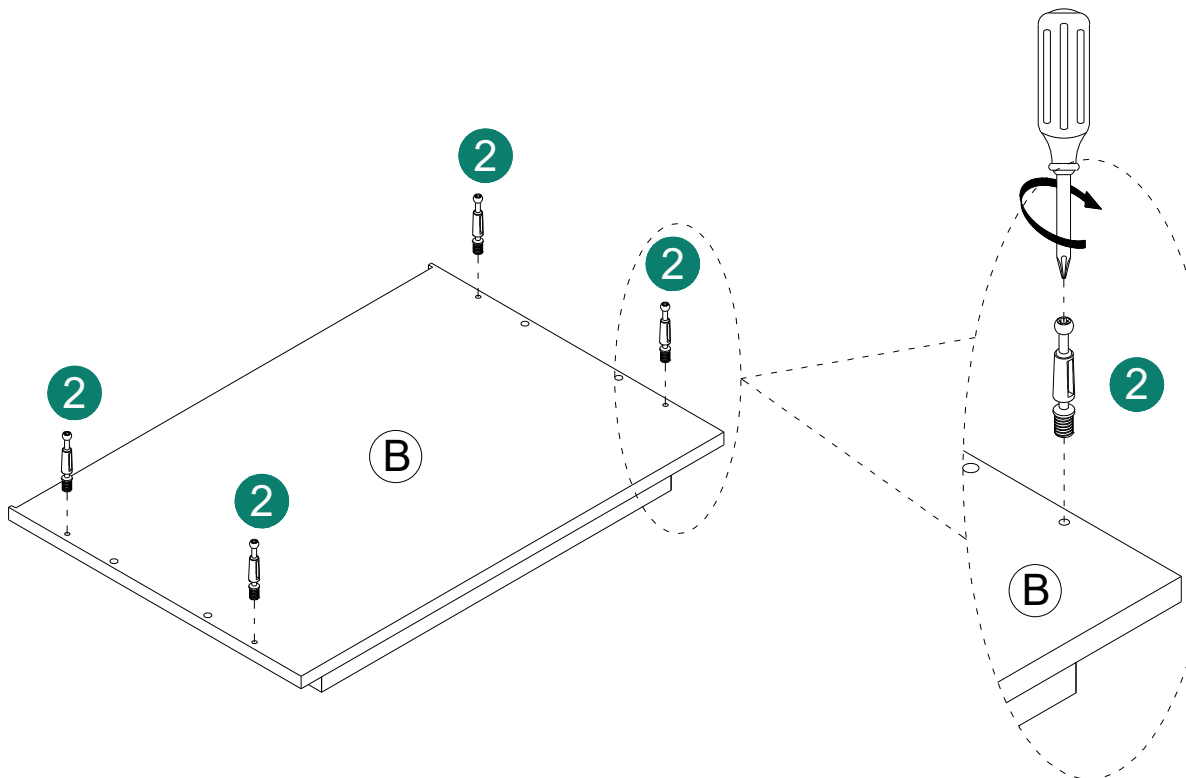
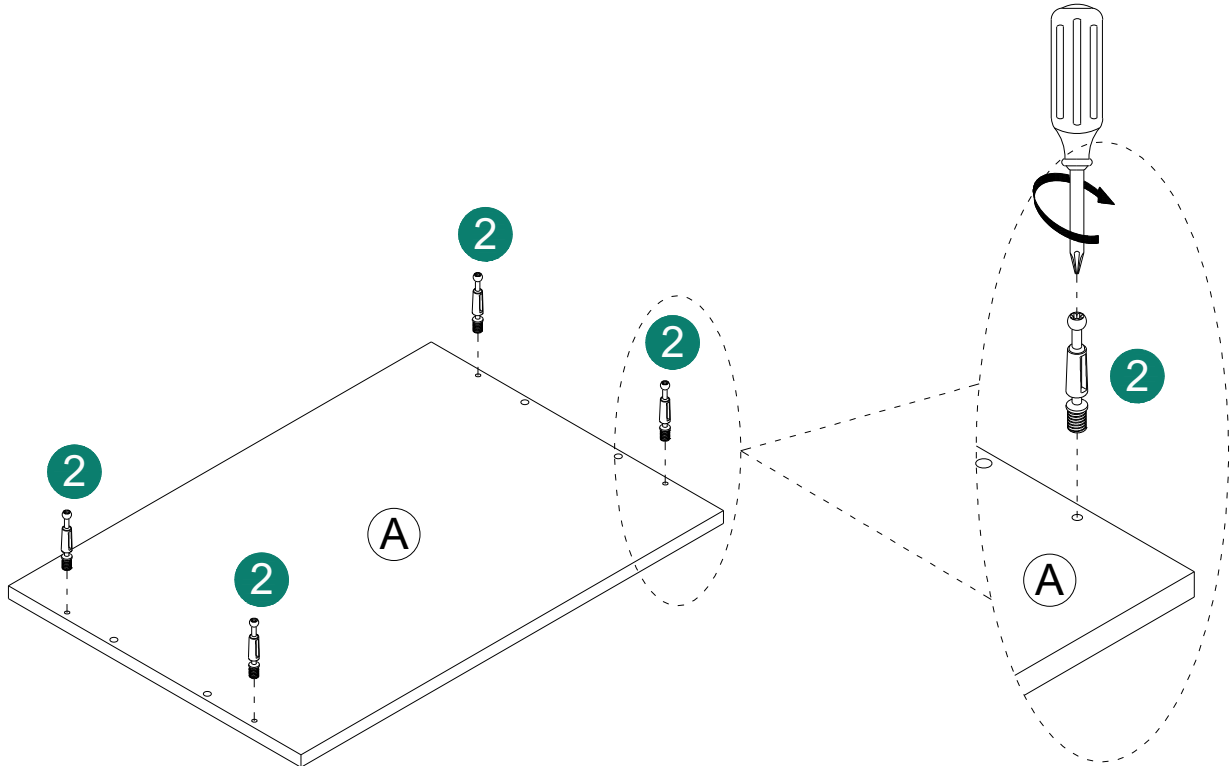

ASSEMBLY INSTRUCTIONS

2

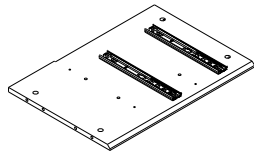

Ⓒ 1PC

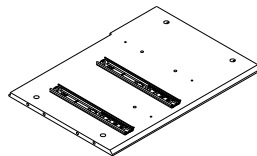

Ⓓ 1PC



② 6PCS

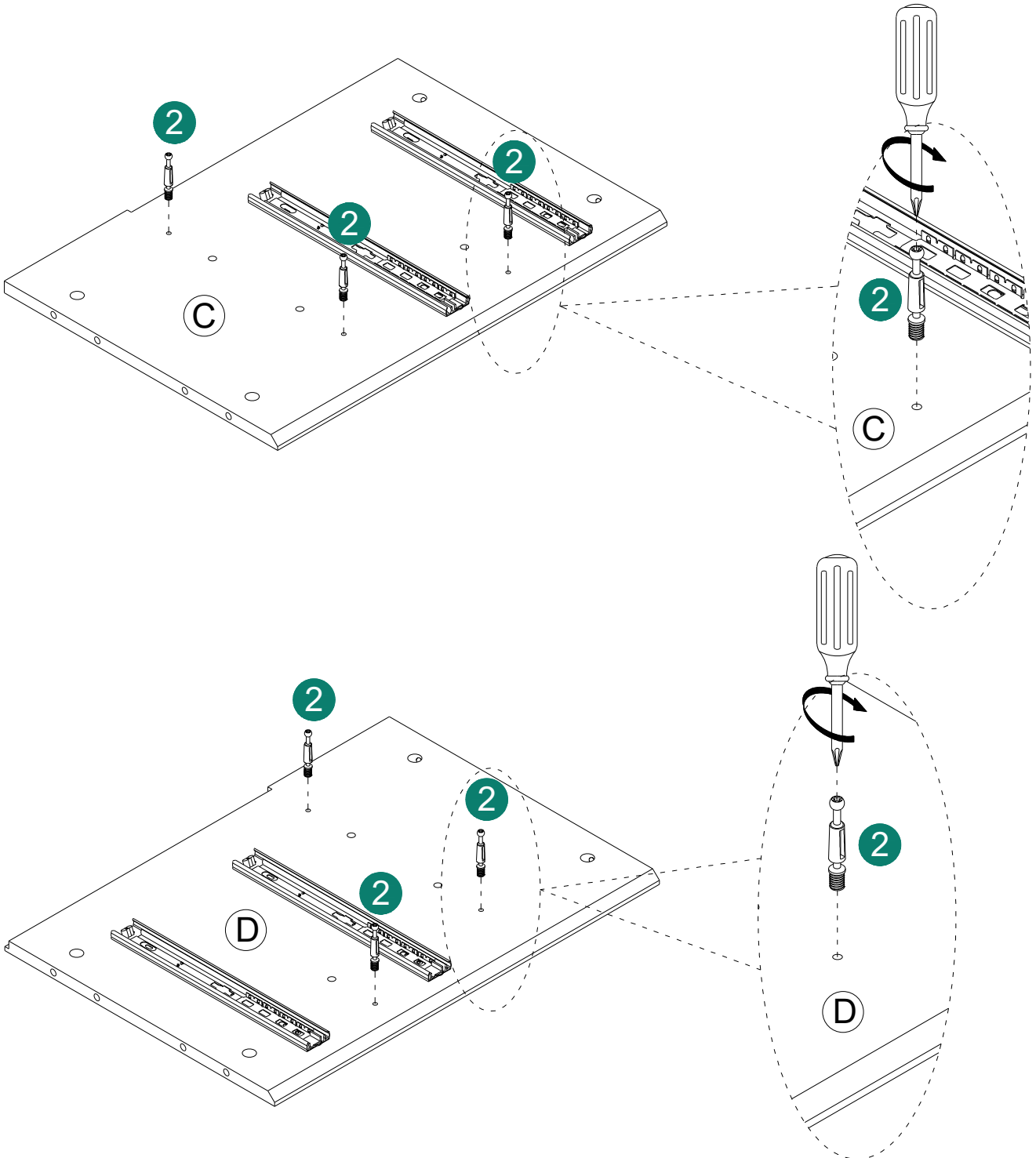

ASSEMBLY INSTRUCTIONS

3

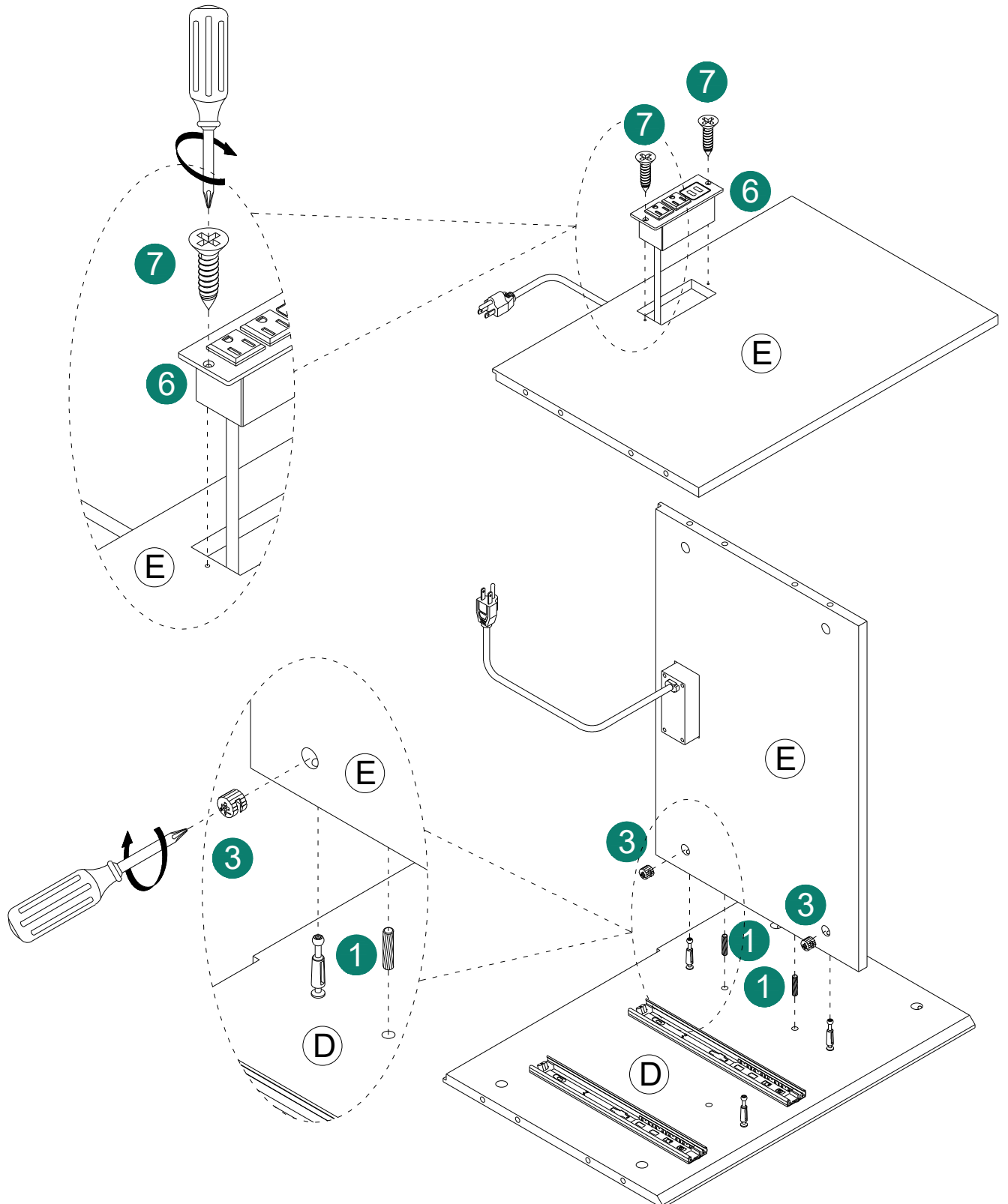
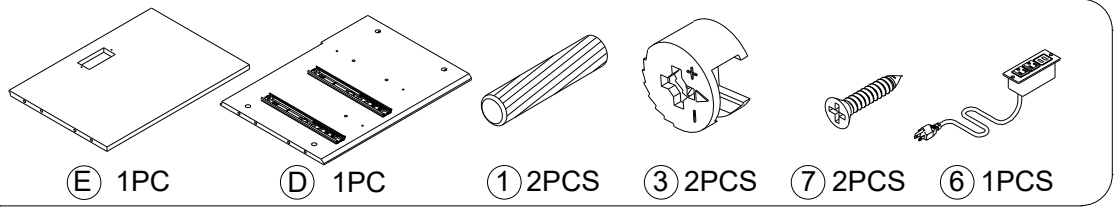

ASSEMBLY INSTRUCTIONS

4

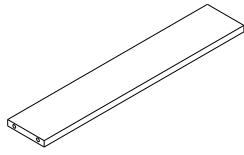

F 1PC

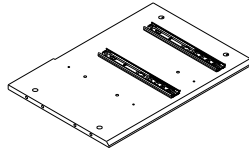

C 1PC

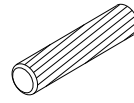

1 4PCS

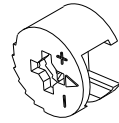

3 4PCS

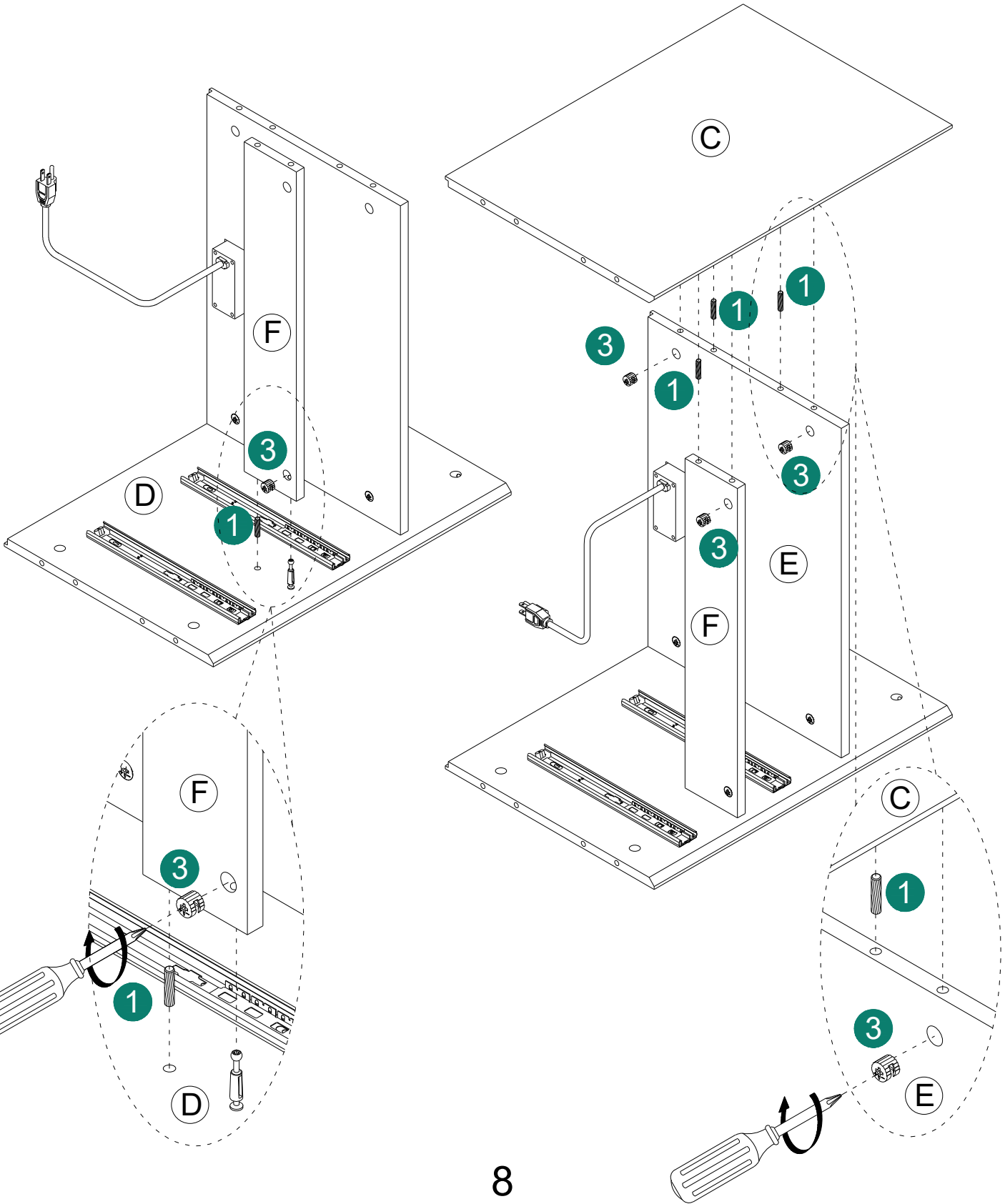

ASSEMBLY INSTRUCTIONS

5

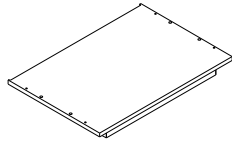

(B) 1PC

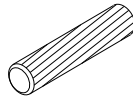

(1) 4PCS

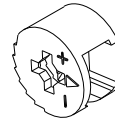

(3) 4PCS

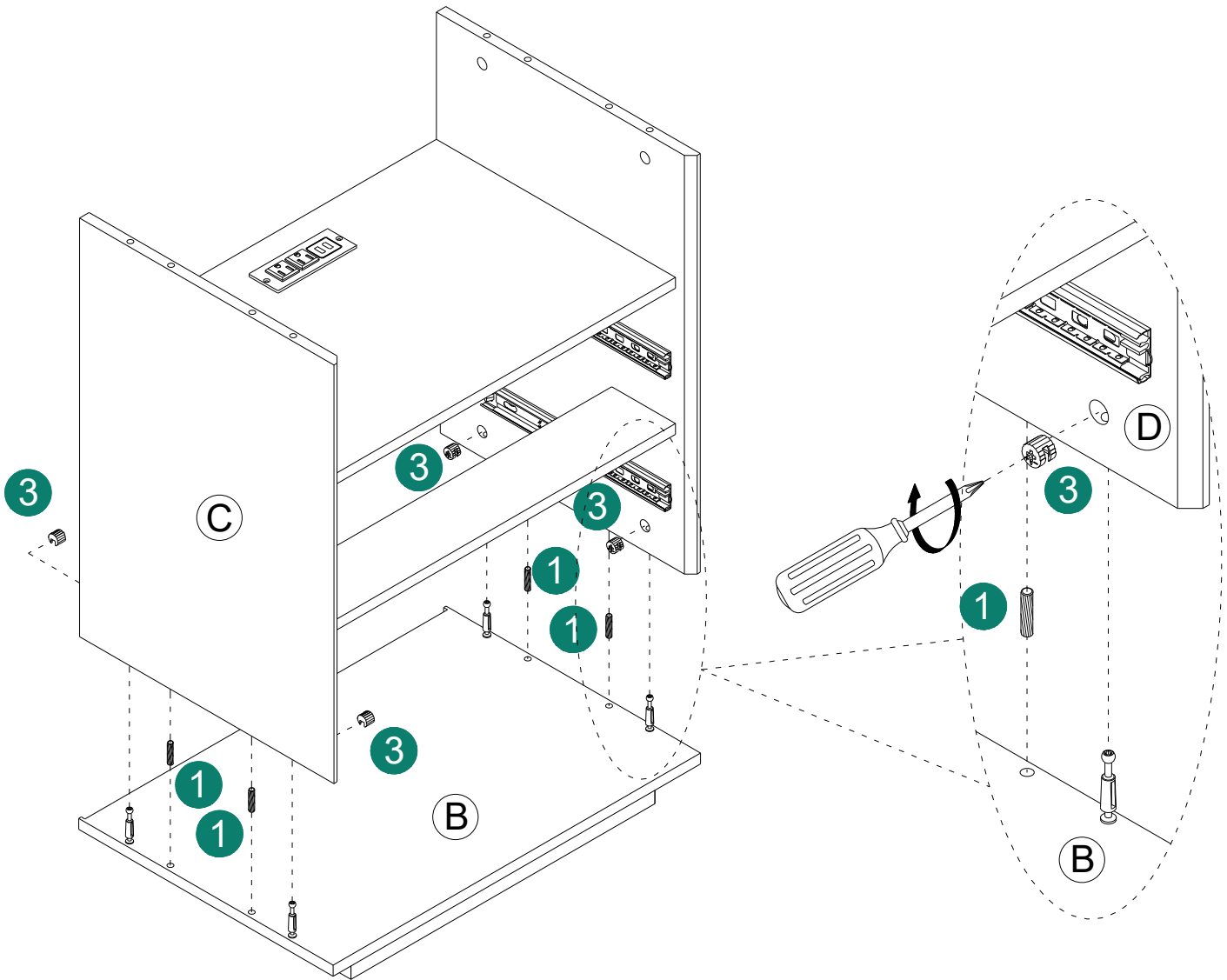

ASSEMBLY INSTRUCTIONS

6

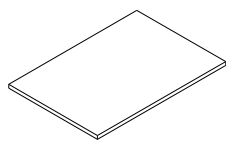

(A) 1PC

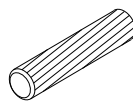

(1) 4PCS

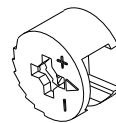

(3) 4PCS

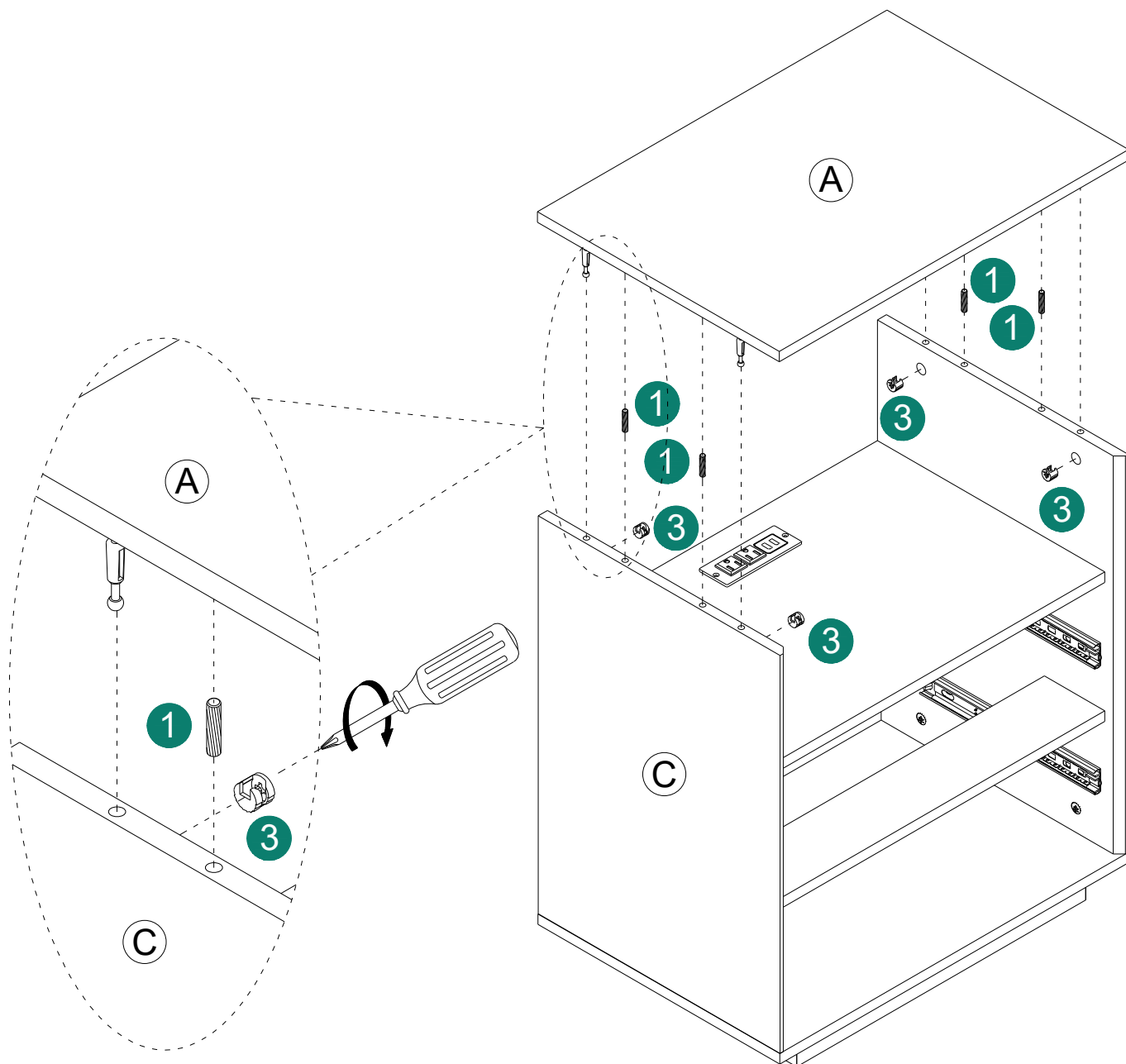

ASSEMBLY INSTRUCTIONS

7

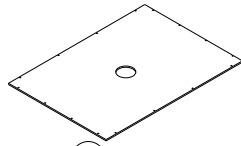

L 1PC

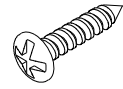

5 16PCS

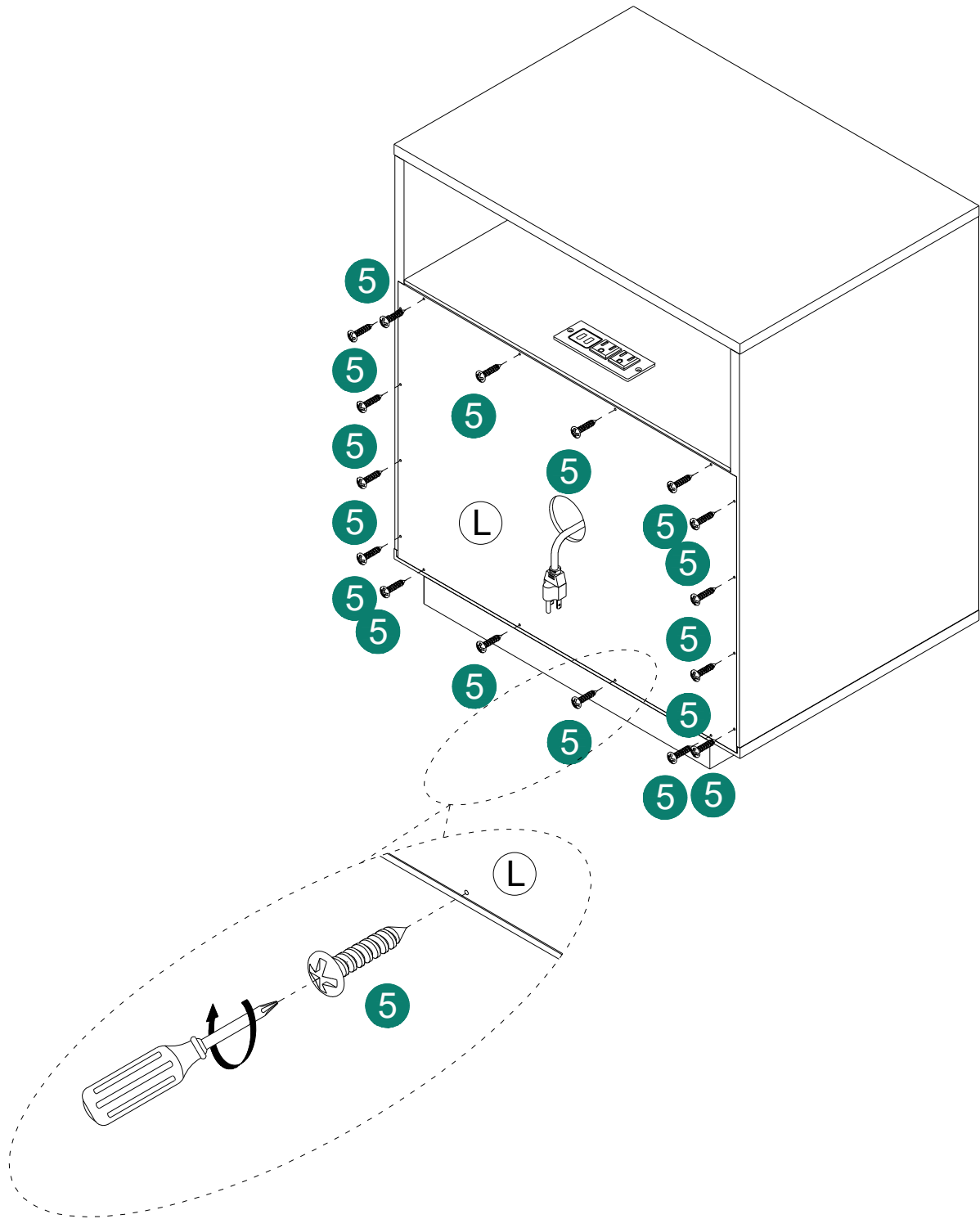

ASSEMBLY INSTRUCTIONS

8

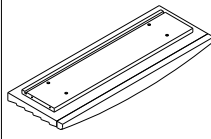

G 2PC

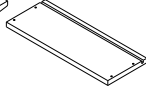

H 2PC

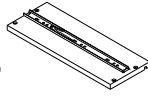

I 2PC

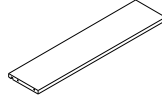

J 2PC

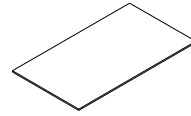

K 2PC

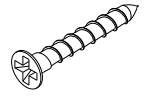

4 16PCS

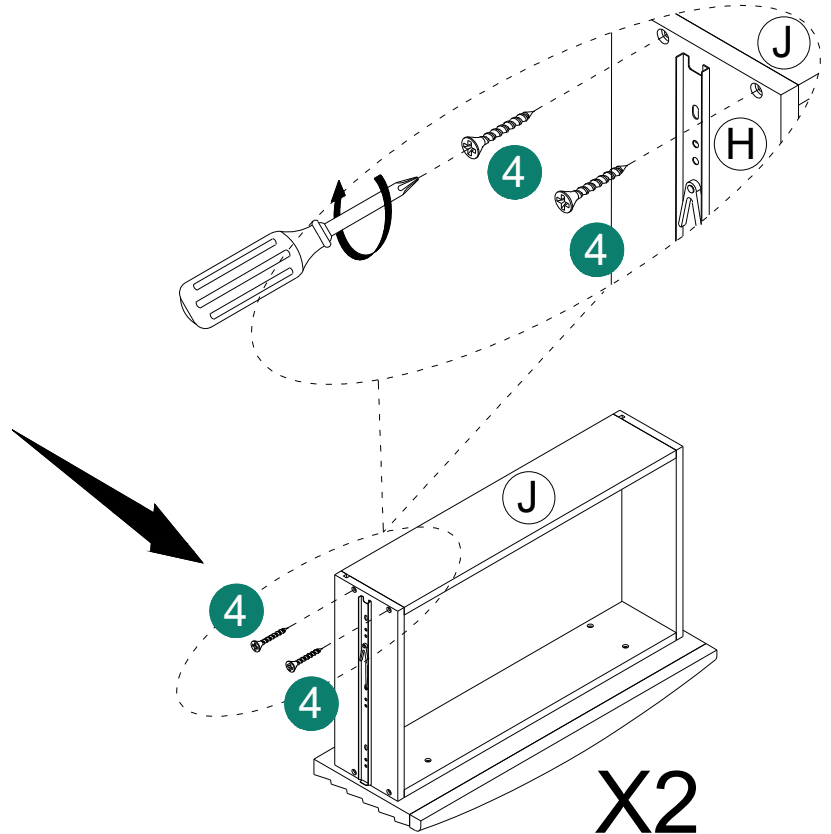
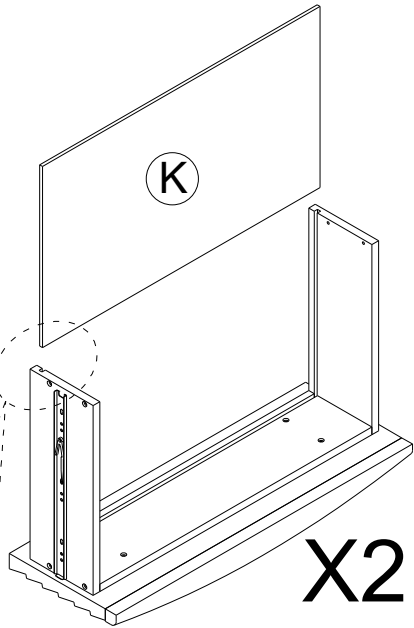
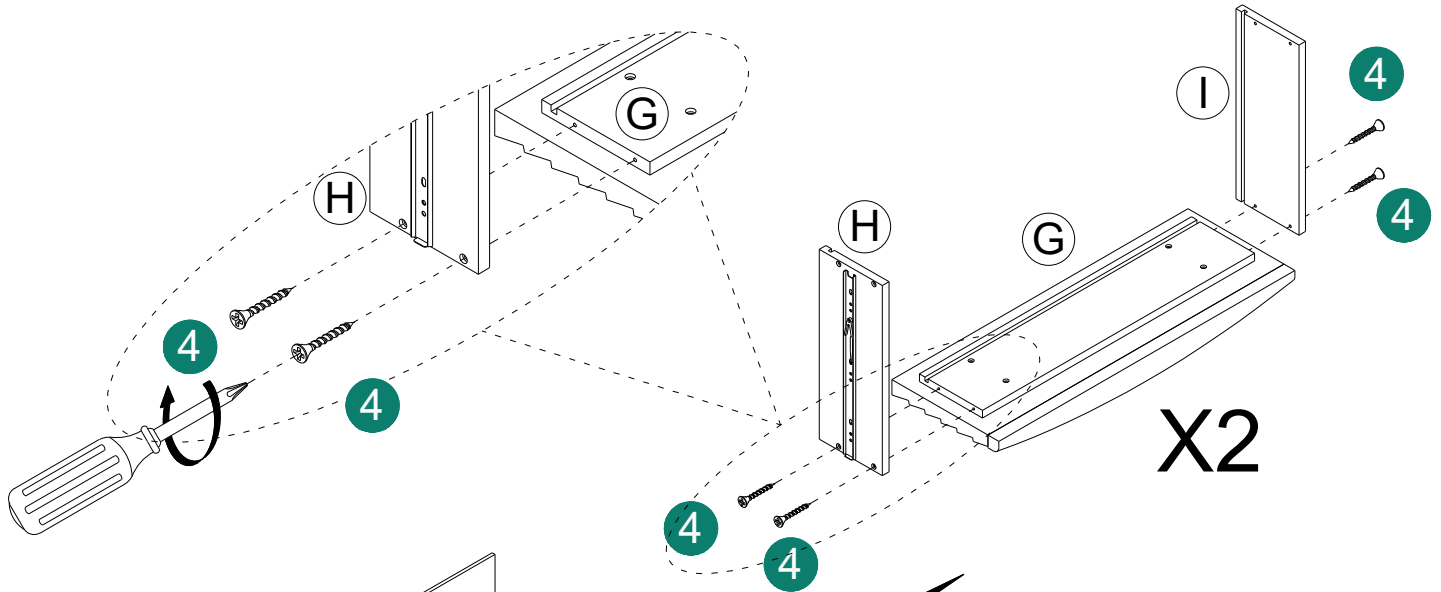

ASSEMBLY INSTRUCTIONS

9

