

3-INCH W X 12-INCH D X 12-INCH H MORRIS BRACKET

FRONT
PROFILE

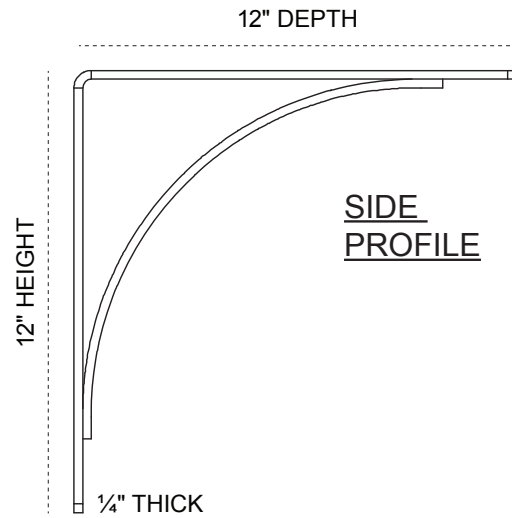
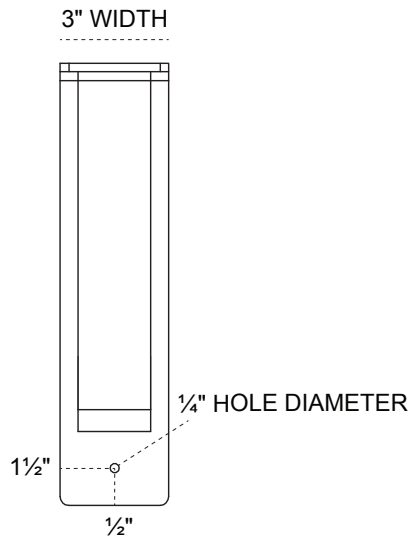

SIDE
PROFILE

ISOMETRIC
PROFILE

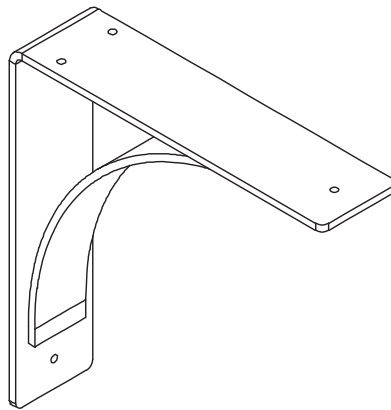

BACK

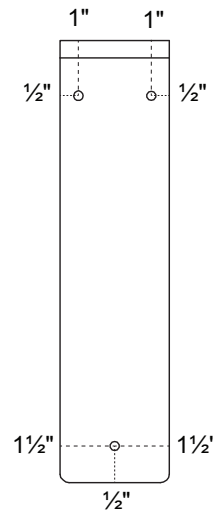

HEAVY-DUTY 1/4" THICK

AVAILABLE IN:
STAINLESS STEEL
ZINC PLATED STEEL
POWDER COATED BLACK

BKTM03X12X12MOSS
BKTM03X12X12MOCRS
BKTM03X12X12MOPBL

P:866.607.0453 | F: 866.591.3143
2300 W. Main St. | Clarksville, TX 75426
sales@ekenamillwork.com | www.ekenamillwork.com



EKENA
MILLWORK