



K-20956

Dual-compartment step trash can

Features

- Dual 5.5-gal. compartments for separating trash and recyclables
- Fits 13-gal. trash bags
- Fingerprint-resistant finish stays clean longer
- Hands-free operation with durable metal foot pedal
- Raised liners and locking rim for easy bag changes
- Quiet-Close™ lid closes gently and silently
- Space-saving profile fits snugly against wall or cabinets
- Hinge design protects wall from scuffs
- Removable plastic liners are easy to clean
- Cleans easily with a microfiber cloth. No need for chemicals or abrasives



Available Colors/Finishes

Color tiles intended for reference only.

- ST Stainless Steel
- BST Black Stainless
- STW Stainless Steel + White



1-800-4KOHLER (1-800-456-4537)
Kohler Co. reserves the right to make revisions without notice to product specifications.
For the most current specification sheet, go to www.kohler.com USA or www.kohler.ca Canada.
3-27-2026 18:31 - US-CA

THE BOLD LOOK
OF **KOHLER**

Codes/Standards

None Applicable

Material

- Available in Stainless Steel, Black Stainless Steel, and White & Stainless Steel
-

Recommended Products/Accessories

K-23729 Stainless steel cleaner

Warranty

See website for detailed warranty information.

KOHLER® Trash Can Limited Warranty



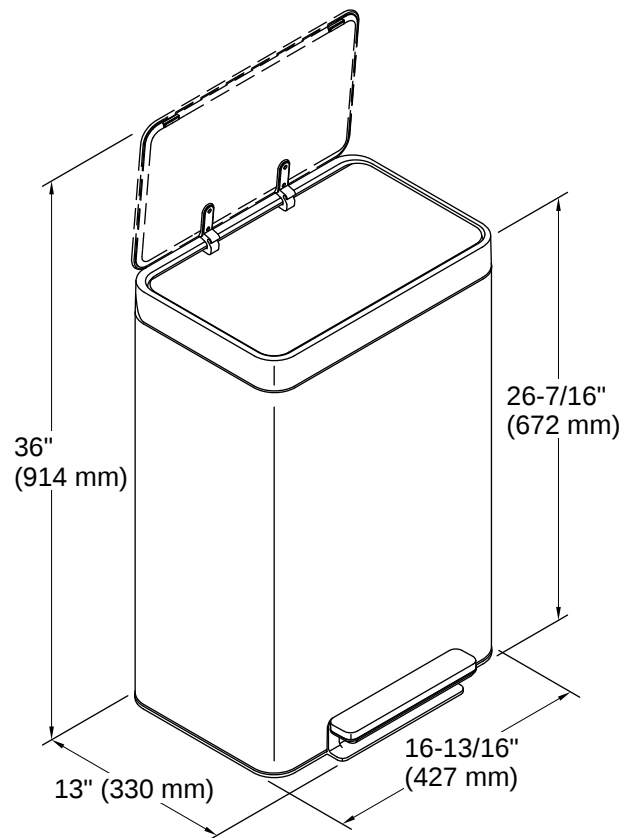

Installation Notes

Install this product according to the installation instructions.

