

# ASSEMBLY INSTRUCTIONS

## TWIN HOUSE BED

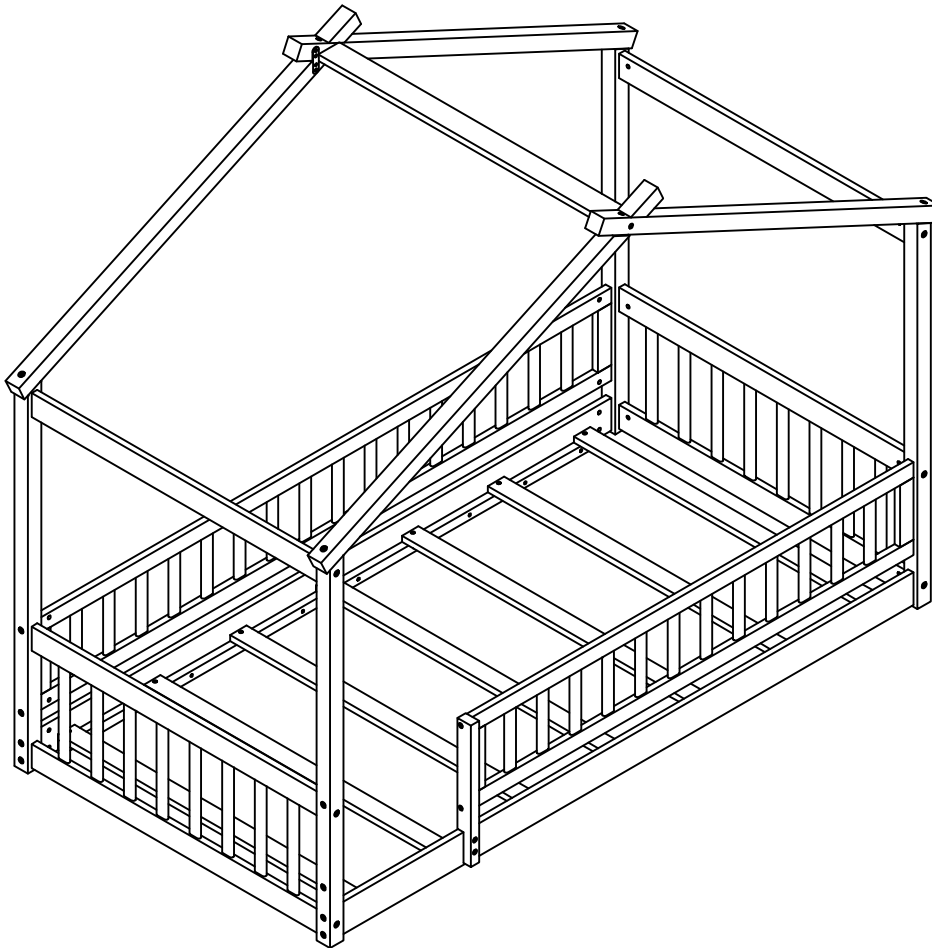





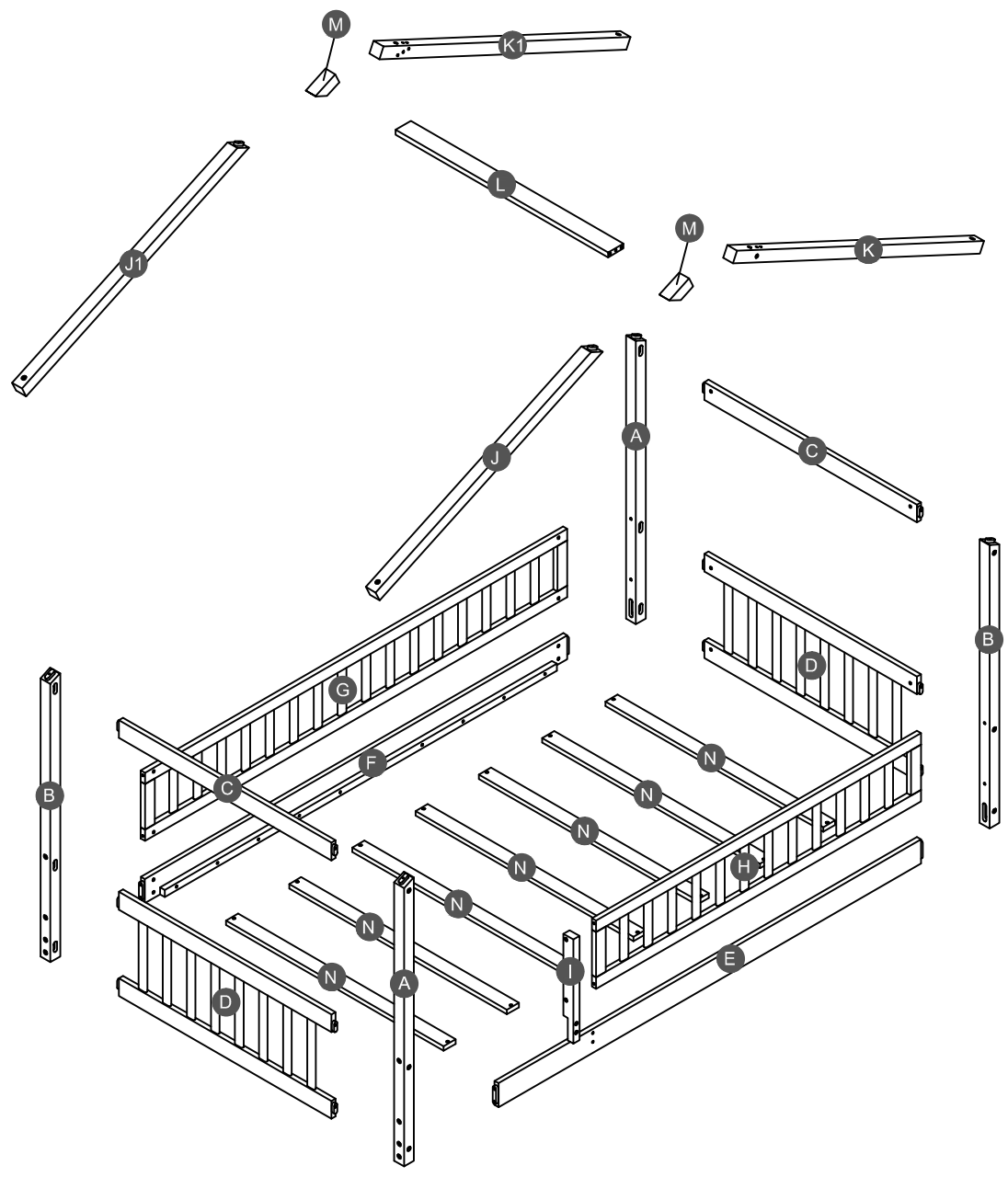

**WF302176**

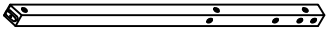
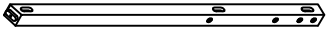
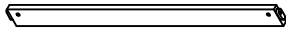
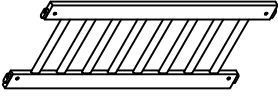

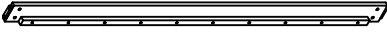
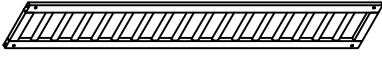
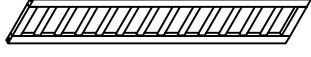

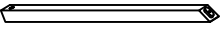
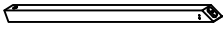
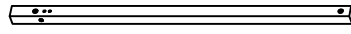
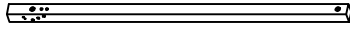
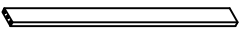

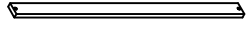

# Detail View

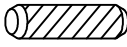
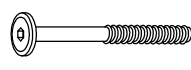
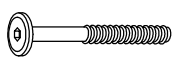

# Part List

<p><b>A</b></p>  <p>Leg (Left Front/Right Back) - 2pcs</p>	<p><b>B</b></p>  <p>Leg (Left Back/Right Front) - 2pcs</p>	<p><b>C</b></p>  <p>Horizontal bar HB/FB - 2pcs</p>
<p><b>D</b></p>  <p>Frame HB/FB - 2pcs</p>	<p><b>E</b></p>  <p>Side rail (Front) - 1pc</p>	<p><b>F</b></p>  <p>Side rail (Back) - 1pc</p>
<p><b>G</b></p>  <p>Long guard rail (Back) - 1pc</p>	<p><b>H</b></p>  <p>Short guard rail (Front) - 1pc</p>	<p><b>I</b></p>  <p>Support guard rail(Left) - 1pc</p>
<p><b>J</b></p>  <p>Upper (Left Front) - 1pc</p>	<p><b>J1</b></p>  <p>Upper (Left Back) - 1pc</p>	<p><b>K</b></p>  <p>Upper (Right Front) - 1pc</p>
<p><b>K1</b></p>  <p>Upper (Right Back) - 1pc</p>	<p><b>L</b></p>  <p>Upper horizontal bar - 1pc</p>	<p><b>M</b></p>  <p>Block - 2pcs</p>
<p><b>N</b></p>  <p>Slats - 7pcs</p>		

# Hardware List

<b>1</b>  Ø8*30mm Wood dowel (6pcs)	<b>2</b>  (Ø15)1/4"*100mm Hex-Head bolts (14pcs)	<b>3</b>  (Ø15)1/4"*80mm Hex-Head bolts (16pcs)
<b>4</b>  (Ø12)1/4"*35mm Hex-Head bolts (2pcs)	<b>5</b>  (Ø12)1/4"*65mm Hex-Head bolts (8pcs)	<b>6</b>  1/4"*15 (9.5mm) Horizontal-Hole bolts(30pcs)
<b>7</b>  (1/4")4.5*58mm Allen key (1pc)	<b>8</b>  Ø4*30mm Wood screws (14pcs)	<b>9</b>  Ø3.5*19mm Wood screws (8pcs)
<b>10</b>  75*20*2 mm Metal bracket (2pcs)		

## ASSEMBLY TOOLS REQUIRED ( NOT INCLUDED )

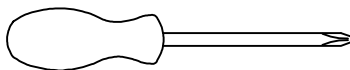

PLEASE BE CAREFUL DO NOT DAMAGE THE HOLE POSITION WHEN YOU USE POWER TOOLS !

**STEP 1:**

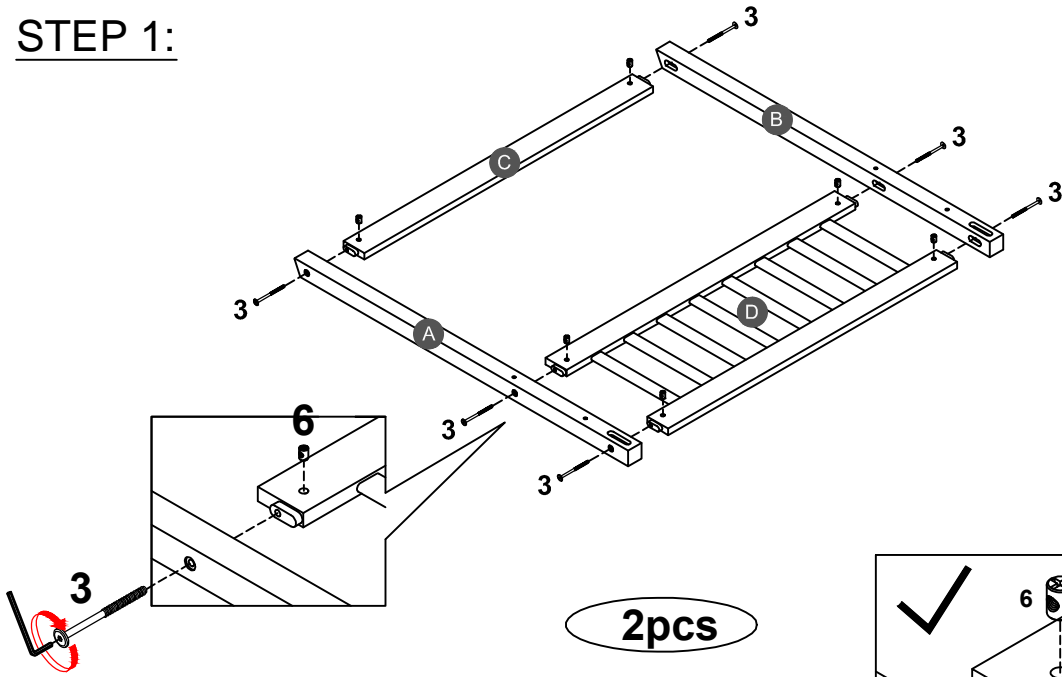

- |              |  |
|--------------|--|
| <b>3</b>     |  |
| <b>12PCS</b> |  |
| <b>6</b>     |  |
| <b>12PCS</b> |  |

Note: Part 6 will face up with the "x" mark on it, otherwise it cannot be tightened

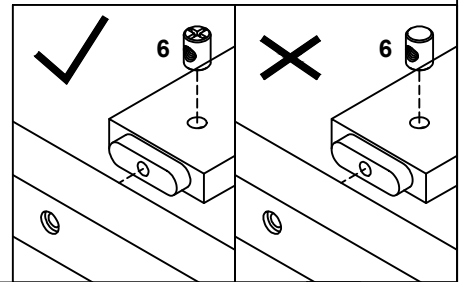



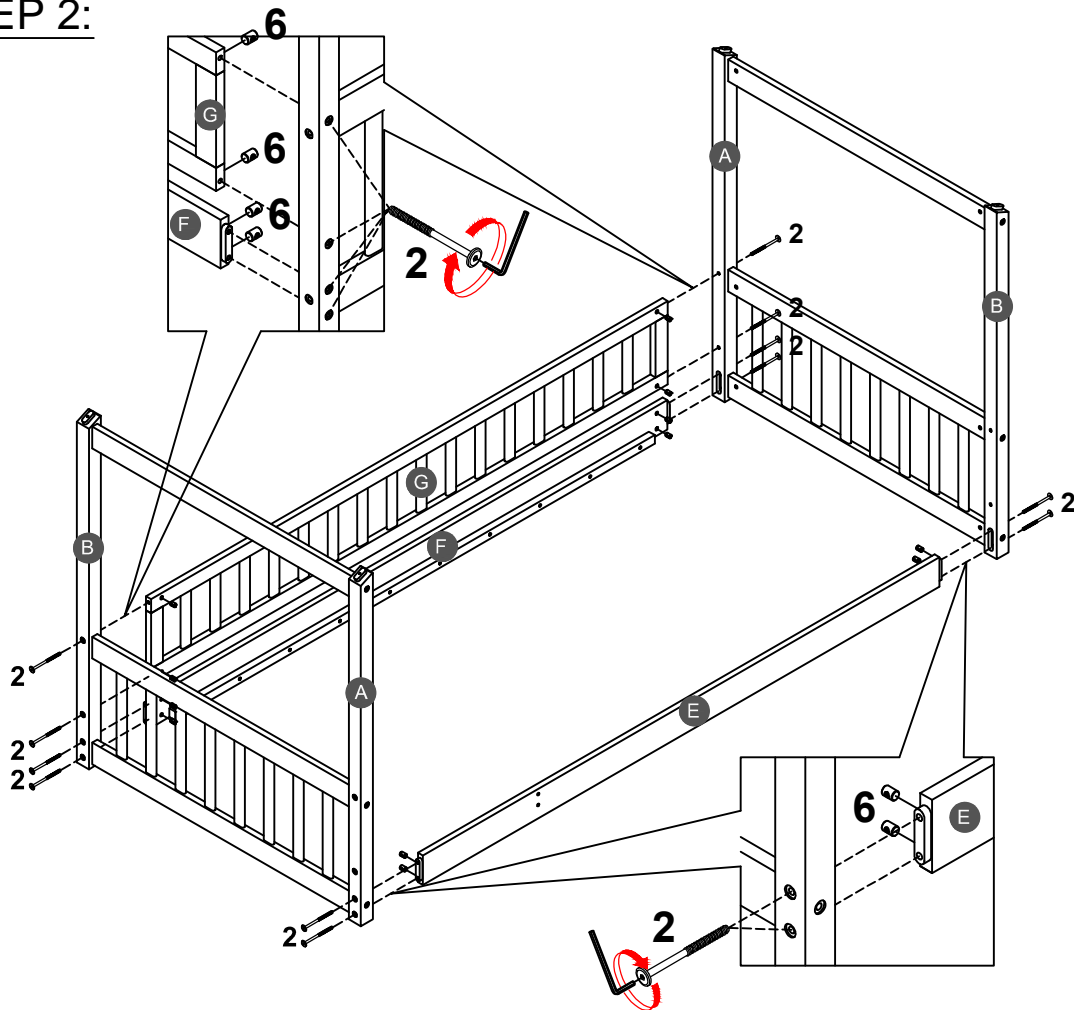

**STEP 2:**





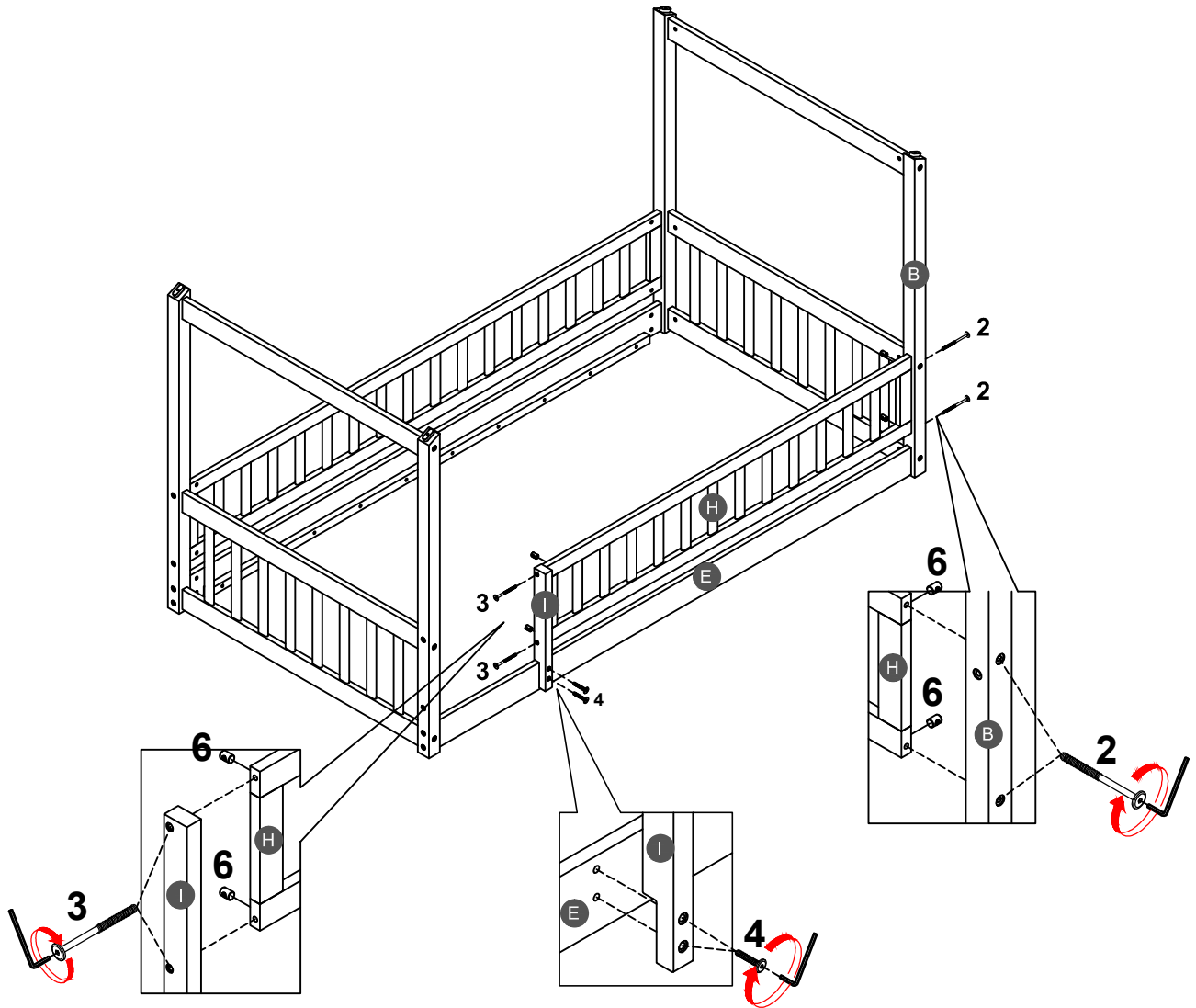

- |              |  |
|--------------|--|
| <b>2</b>     |  |
| <b>12PCS</b> |  |
| <b>6</b>     |  |
| <b>12PCS</b> |  |

**STEP 3:**

<b>2</b>		<b>3</b>		<b>4</b>		<b>6</b>	
<b>2PCS</b>		<b>2PCS</b>		<b>2PCS</b>		<b>4PCS</b>	



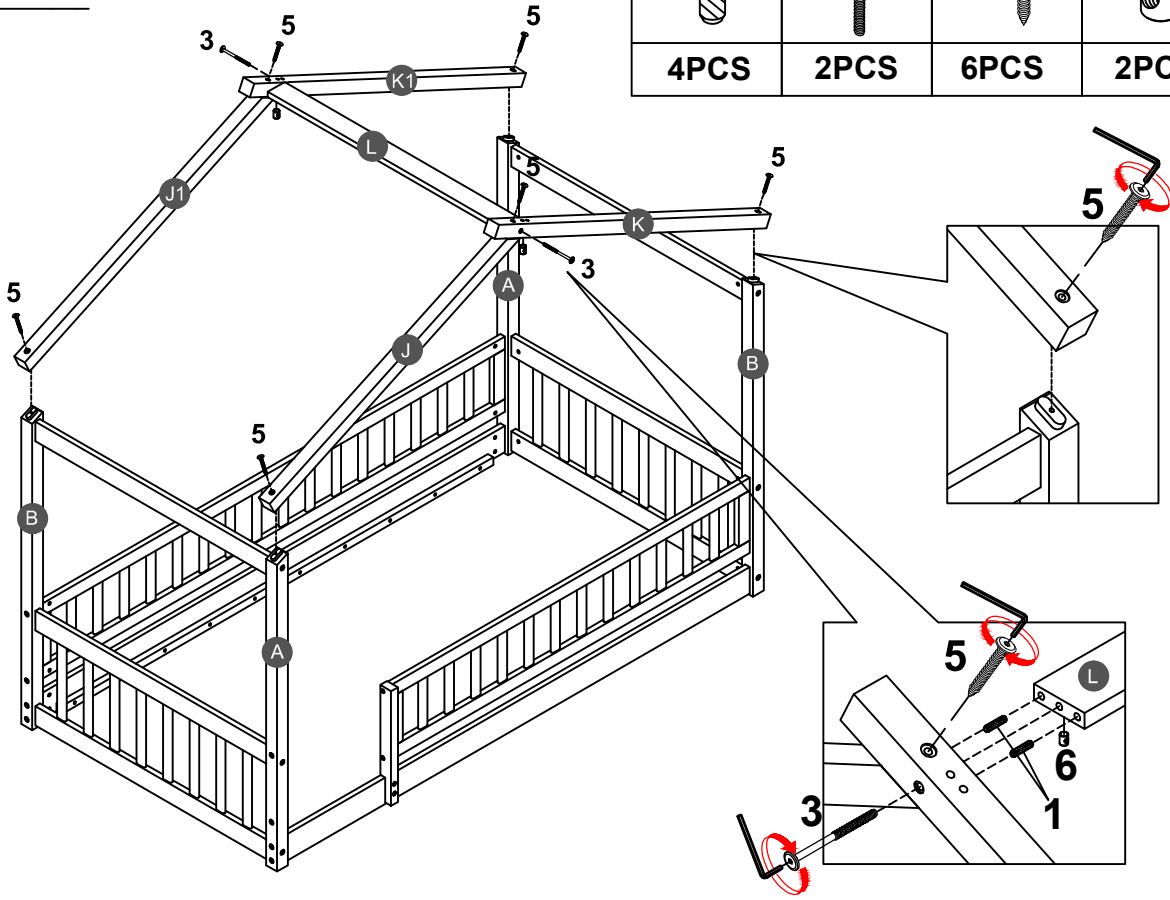

**STEP 4:**

<b>1</b>		<b>3</b>		<b>5</b>		<b>6</b>	
<b>4PCS</b>		<b>2PCS</b>		<b>6PCS</b>		<b>2PCS</b>	



**STEP 5:**

<b>1</b>	
<b>2PCS</b>	
<b>5</b>	
<b>2PCS</b>	

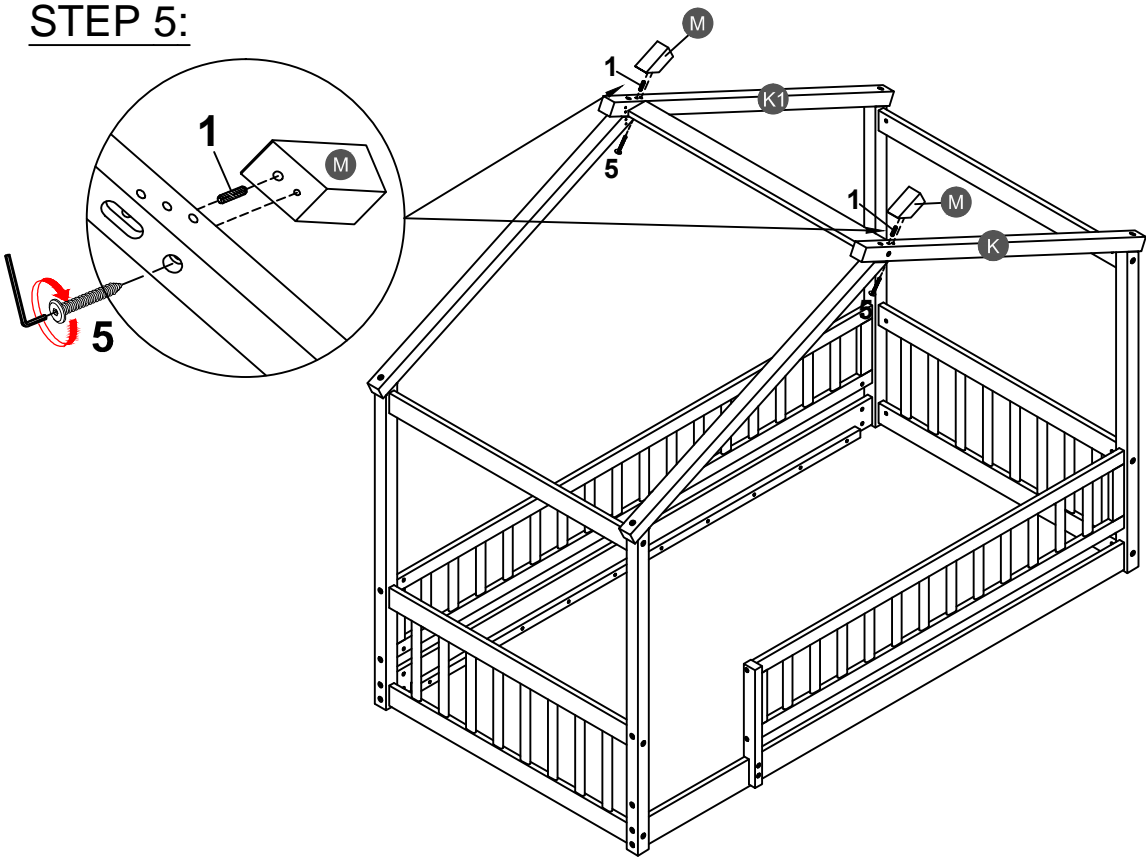

**STEP 6:**

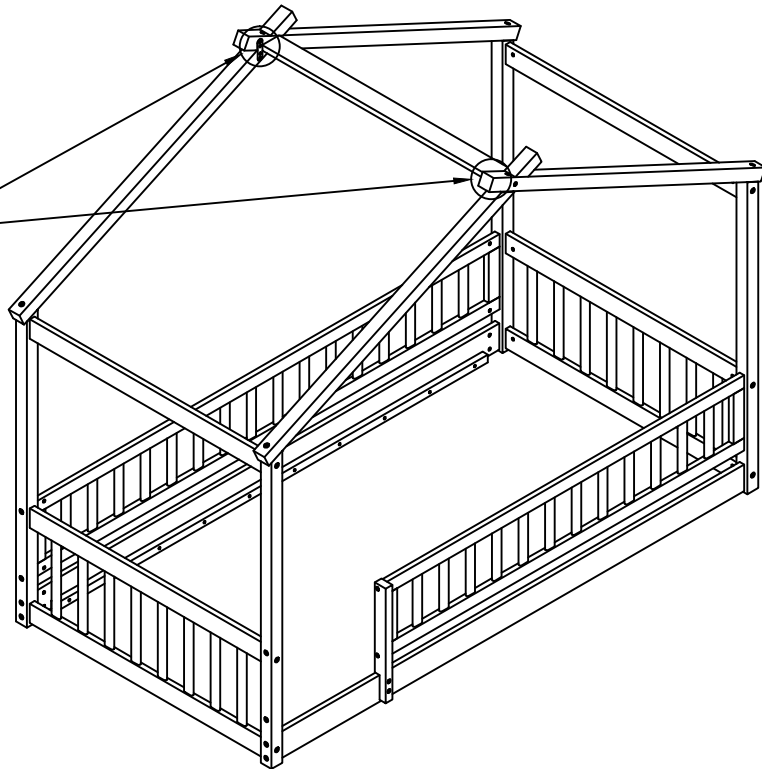
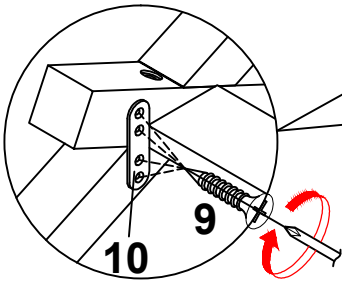

9	
8PCS	
10	
2PCS	

**STEP 7:**

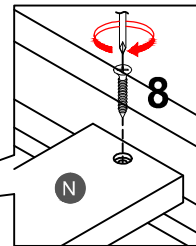
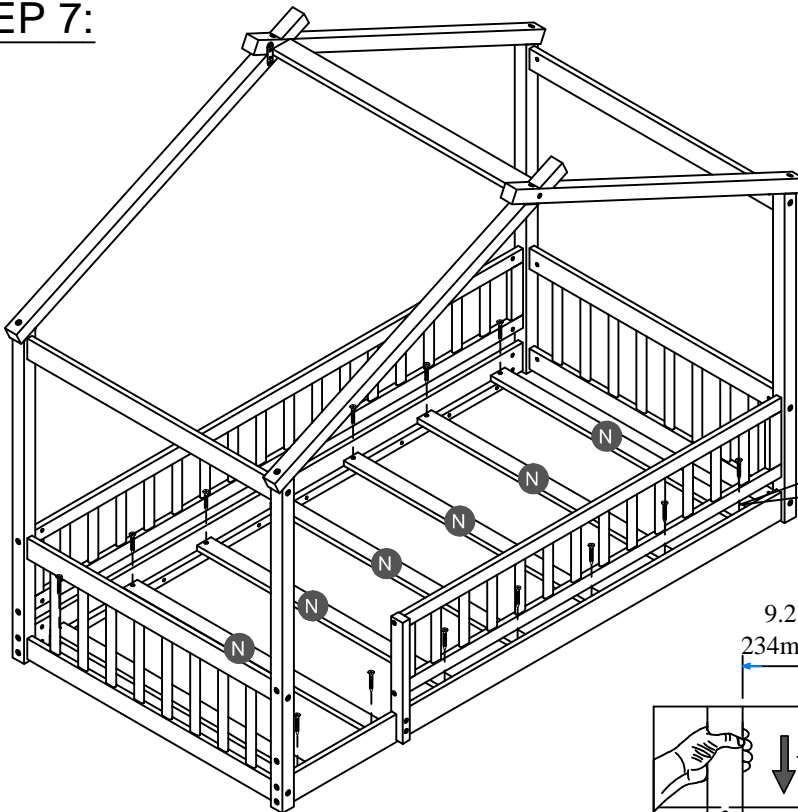

8	
14PCS	

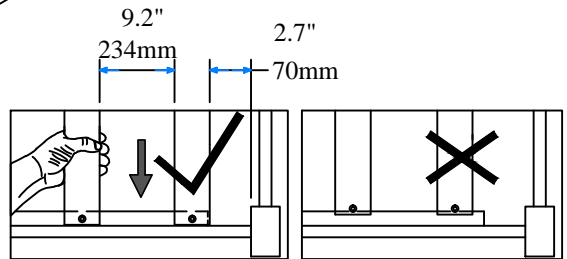

Note: Do not lock the screws of the bed slats to the outermost edge of the bed slats, you need to leave a certain space at the edges, otherwise it will cause the board to break. Do not lock the bed slats on the edge of the wood, please hold firmly before screwing, hold it in place with one hand, then lock the screw.