

LED Lighted Mirror

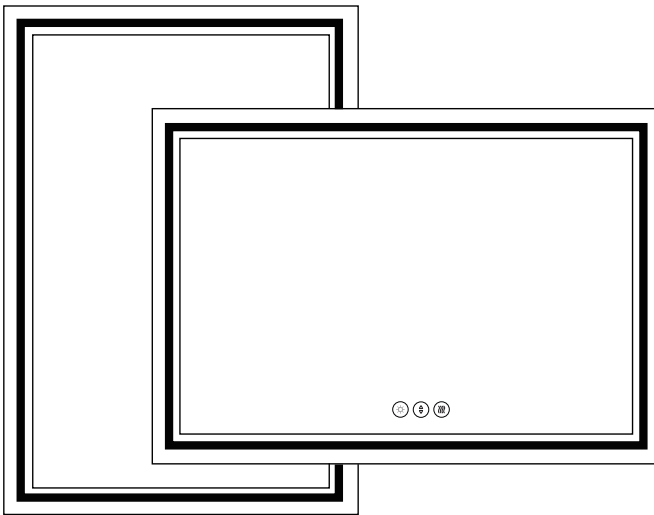

For easy and safe installation, please refer to the following:

- Read all instructions thoroughly before installing the enclosed product
- Read and take note of all safety, care and maintenance information.

**PLEASE KEEP THIS MANUAL FOR FUTURE REFERENCE
DURING PRODUCT OPERATION AND MAINTENANCE.**

SAFETY INSTRUCTIONS

Thank you very much for choosing our led lighted mirror. For your safety, it is very important that the following instructions are read carefully and completely before beginning the assembly and installation of this lighting fixture:

WARNING -TO REDUCE THE RISK OF BURNS, FIRE, ELECTRICAL SHOCK OR INJURY TO PERSONS:

1. It is strongly recommended that two or more adults install this led lighted mirror.
2. Disconnect power at the circuit breaker before putting on or taking off parts. To disconnect, turn all controls to the off position, then disconnect power from the AC/DC adaptor.
3. Use only power adaptor that was provided with this product. Using a different power adaptor will damage the lights and may cause fire, electrical shock hazard.
4. Always wear suitable eye protection before drilling.
5. Keep the voltages between 110V and 120V. If the voltage exceeds 120v, please use the transformer.
6. Use this furnishing only for its intended use as described in these instructions. Do not use attachments/accessories not recommended by the manufacturer.
7. Never operate this furnishing if it is not working properly or if it has been dropped or damaged, or dropped into water.
8. Do not use outdoors. FOR HOUSEHOLD AND INDOOR USE ONLY.
9. Do not operate where aerosol (spray) products are being used or where oxygen is being administered.
10. The appliance is not to be used by persons (including children) with reduced physical, sensory or mental capabilities, or lack of experience and knowledge, unless they have been given supervision or instruction. Children should be supervised to ensure that they do not play with the appliance.



CAUTION:

1. Risk of Electrical Shock – Connect this furnishing to a properly grounded outlet only.
2. Grounding Instructions: This product must be connected to a grounded metal, permanent wiring system, or an equipment-grounding conductor must be run with the circuit conductors and connected to the equipment-grounding terminal or lead on the product.

PRE-ASSEMBLY

PRE-ASSEMBLY ATTENTIONS:

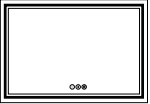
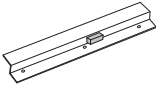
1. After opening the package, please inspect the product immediately for any damage during transit or missing parts.
2. Remove all parts and hardware from the box along with any plastic protective packaging.
3. Do not discard any contents until after assembly is complete to avoid accidentally discarding small parts or hardware.
4. **Before drilling, please ensure there are no hidden cables or pipes (water, gas, or electrical) behind hanging points.**

What's in the box			
No.	Description	Draw	QTY.(pcs)
A	Led Lighted Mirror		1
B	Top Mounting Bracket with Spirit Level		Ref. to Page 8
C	Phillips Flat Head Screws		Ref. to Page 8
D	Wall Anchor		Ref. to Page 8

TOOLS (not included)



Electric Drill



Masking Paper



Tape Measure



Phillips-head screwdriver



Hammer





Safety Goggles

WALL ANCHORING

Secure it! Wall Anchoring Guide

This mirror must be securely attached to the wall. The hardware used to secure your mirror to the wall depends on your wall material. If your wall material is not listed or if you have any questions, consult with a local hardware retailer.

Thickness of Wall	Applicable Anchors&Screws	Recommended Drill Bit	Recommended Drill Depth
>5/8"(16mm)		5/16"(8mm)	50mm
5/16"-5/8"(8-16mm)		25/64"(10mm)	
<5/8"(8mm)		Unapplicable	Unapplicable

WALL MATERIAL

Masonry (concrete or brick
Mortar)

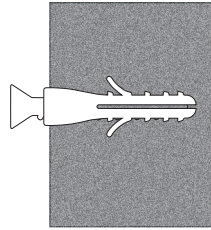

ANCHORING DEVICE (Anchor A Set)

Plug with screw.

WALL MATERIAL

Drywall or plaster with available
wood stud

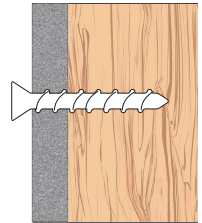
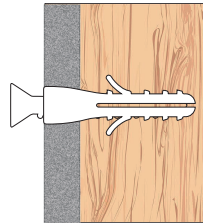

ANCHORING DEVICE (Anchor A Set)

Screw inserted directly into stud
or plug with screw.

WALL MATERIAL

1. Drywall without available wood stud
2. Hollow Wall

ANCHORING DEVICE (Anchor B Set)

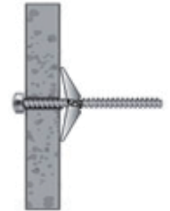

WIRE CONNECTION

Safety First! Wire Connection Guide

There are two ways to connect the power. You can connect the wires directly to your junction box or insert the plug directly into the wall socket.

- Grounding Instructions: This product must be connected to a grounded metal permanent wiring system or an equipment-grounding conductor must be run with the circuit conductors and connected to the equipment grounding terminal or lead on the product.

PLUG IN

Insert the plug to the socket

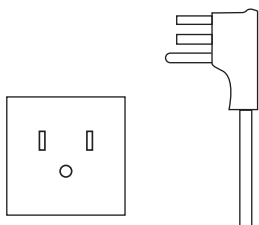

HARDWIRED

Cut the electric wire and make connection with junction box.

DEVICE

Junction box (not included).

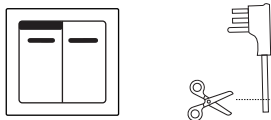

DANGER: Before installation, make sure the main power is cut off.

HOW TO CONNECT THE WIRES

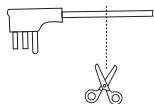

Using wire connector caps

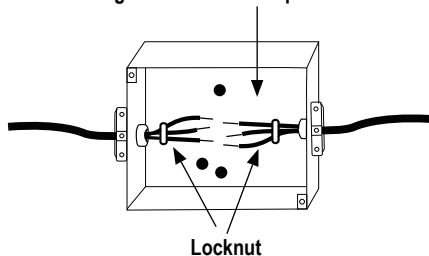

★ junction box is not included ★

BLACK WIRE --- POWER SUPPLY L (LINE)
WHITE WIRE --- POWER SUPPLY N (NEUTRAL)
GREEN WIRE --- POWER SUPPLY G (GROUND)

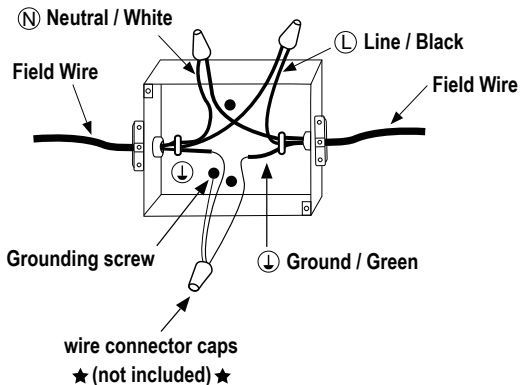

EASY TO INSTALLATION

1

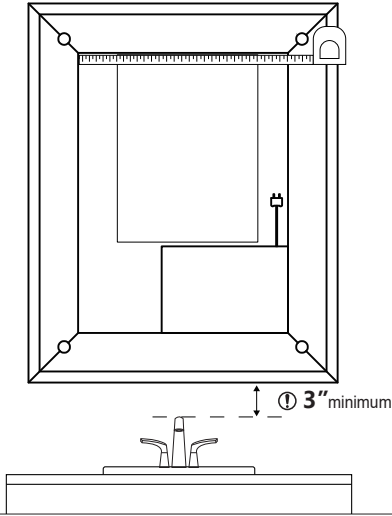

Measure the length of the built-in installation bar on the back of the mirror.

2



Draw a horizontal line on the wall that matches the length of the installation bar.

3

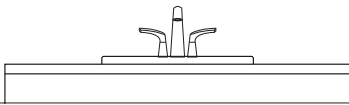
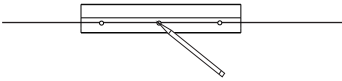

Align the holes on the hangers with the line and make marks.

4

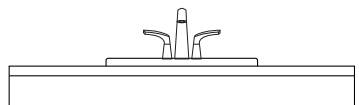

Use an electric drill to punch holes at the marked spots. (drill bit in 8mm (5/16") , drilling depth in 50mm (1-15/16"))

EASY INSTALLATION

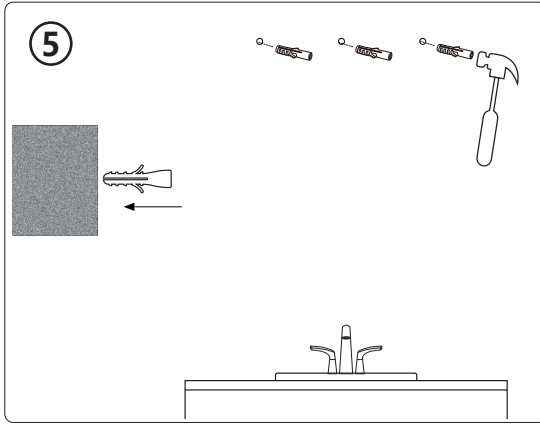

- Plug the plastic anchors into the holes.

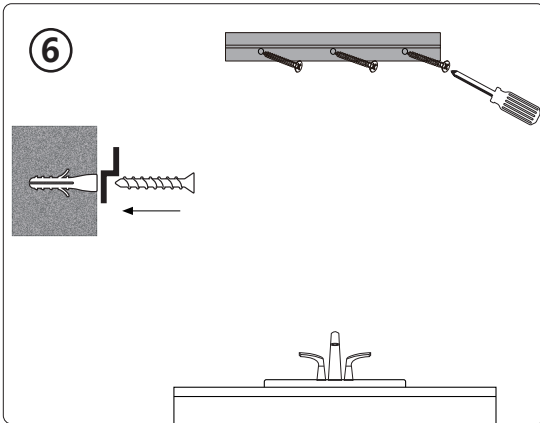

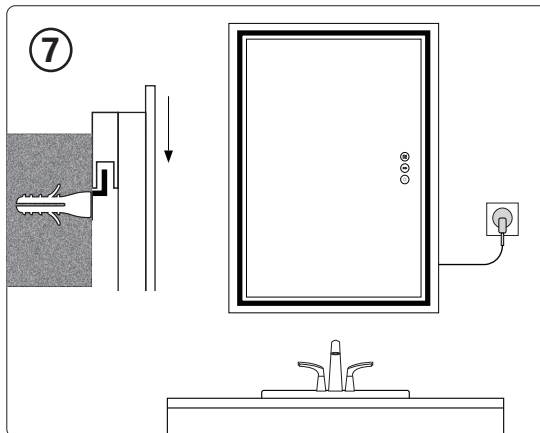

- Fasten the mounting bracket to the wall.



- Connect the power supply.
(ref. to page 4)
- 2 adults to hang the mirror.

BUTTON CONTROL

TURN ON/OFF:

Touch  once to turn on the lighting and touch  three times to turn it off.

STEPLESS DIMMING:

Long Hold  to dim or brighten the light. (Factory setting: the brightness has been adjusted to 100%; if you think it is too dazzling, you can long press it again to reduce the brightness to your preference)

COLOR:

Hold  to switch the color temperature of the light.

DEFOGGER:

Touch  to turn on/off defogging function. When defogger is on, the button should be in white color. Defogger will turn off automatically after 60 minutes, touch the key to turn on.

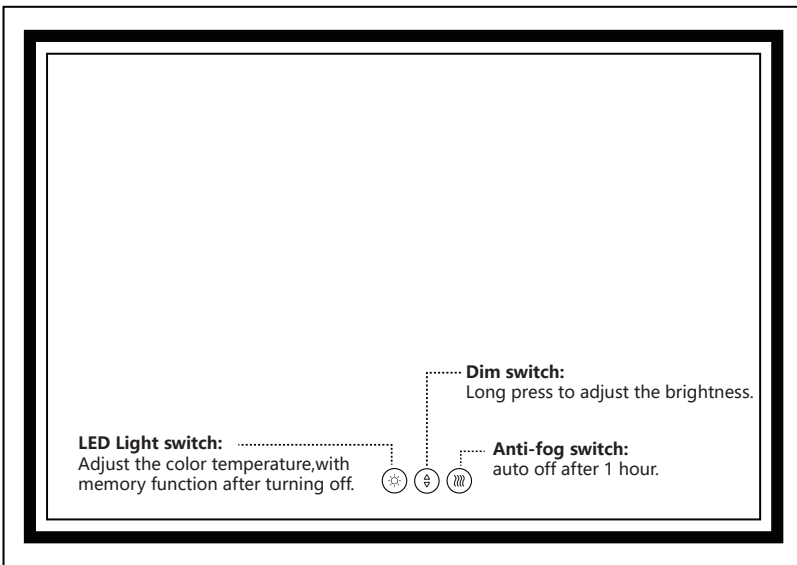

38mm
(1-1/2")

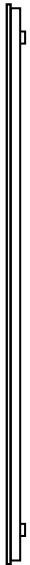

PRODUCT SPECIFICATION

Dimension	Size (mm)	Input Power	Input Current	Defog Size (mm)	Mounting Bracket (mm)	No. of Top Mounting Bracket	No. of Screws & Wall Anchor for Bracket (Set)
20"*28"	508*710*38	24W	1A	250*250	280	1	3
24"*32"	607*810*38	24W	1A	300*400	280	2	6
24"*36"	607*912*38	36W	1.5A	300*400	280	2	6
24"*40"	607*1016*38	36W	1.5A	300*400	280	2	6
28"*36"	710*912*38	36W	1.5A	300*400	410	1	4
28"*60"	710*1524*38	48W	2A	350*800	410	2	8
30"*55"	760*1397*38	48W	2A	350*800	410	2	8
32"*40"	810*1016*38	36W	1.5A	350*500	500	1	4
32"*48"	810*1216*38	36W	1.5A	350*500	410	2	8
32"*72"	810*1824*38	60W	2.5A	350*1000	500	2	8
32"*84"	810*2130*38	60W	2.5A	350*1200	500	2	8
36"*36"	910*910*38	36W	1.5A	350*500	500	1	4
36"*48"	910*1216*38	48W	2A	350*500	410	2	8
36"*60"	910*1524*38	48W	2A	350*800	410	2	8
36"*72"	910*1824*38	60W	2.5A	350*1000	500	2	8
36"*96"	910*2430*38	90W	3.75A	350*1500	500	3	12
40"*84"	1016*2130*38	90W	3.75A	400*1200	500	2	8
40"*110"	1016*2794*38	90W	3.75A	400*1500	500	3	12
30"*36"	760*912*38	36W	1.5A	300*400	410	1	4
36"*55"	912*1397*38	48W	2A	350*800	410	2	8
24"*30"	607*760*38	24W	1A	250*250	280	1	3
32"*36"	810*912*38	36W	1.5A	350*500	500	1	4
38"*38"	965*965*38	36W	1.5A	350*500	500	1	4
30"*30"	760*760*38	36W	1.5A	300*400	410	1	4
38"*40"	965*1016*38	36W	1.5A	350*500	500	1	4
26"*32"	660*810*38	24W	1A	300*400	280	2	6

OTHER SPECIFICATION:

PARAMETER	SPECIFICATION
Stepless Dimming	10%-100%
Color Temperature	3000K/4000K/6500K
LED Light Quantities	192pcs/M
LED Life Span	50,000 hours
CRI	90+
Anti-fog	YES
Memory Function	YES
Tempered Glass	YES
Lighting Lens Material	Acrylic
Input Voltage	120V AC
Output Voltage	24V DC
Working Temperature	-20 ~ +50°C
Wiring Method	Hardware/Plug in
Switch	Touch Sensor

CUSTOMER SERVICE

WARRANTY:

This product is guaranteed to operate 1 years from the original date of purchase. This warranty is considered void if the product fails from misuse. If, under normal use and for the full time period, your product fails to operate, please contact us. We will be glad to solve the problem for you!

CARE & CLEANING:

1. Use a household liquid glass cleaner to keep the mirror surface clean.
2. Do not use abrasive cleaners containing ammonia.