

PARTY TENT

13X20FT

SKU: E002G069-1
E002G069-2

ASSEMBLY INSTRUCTIONS

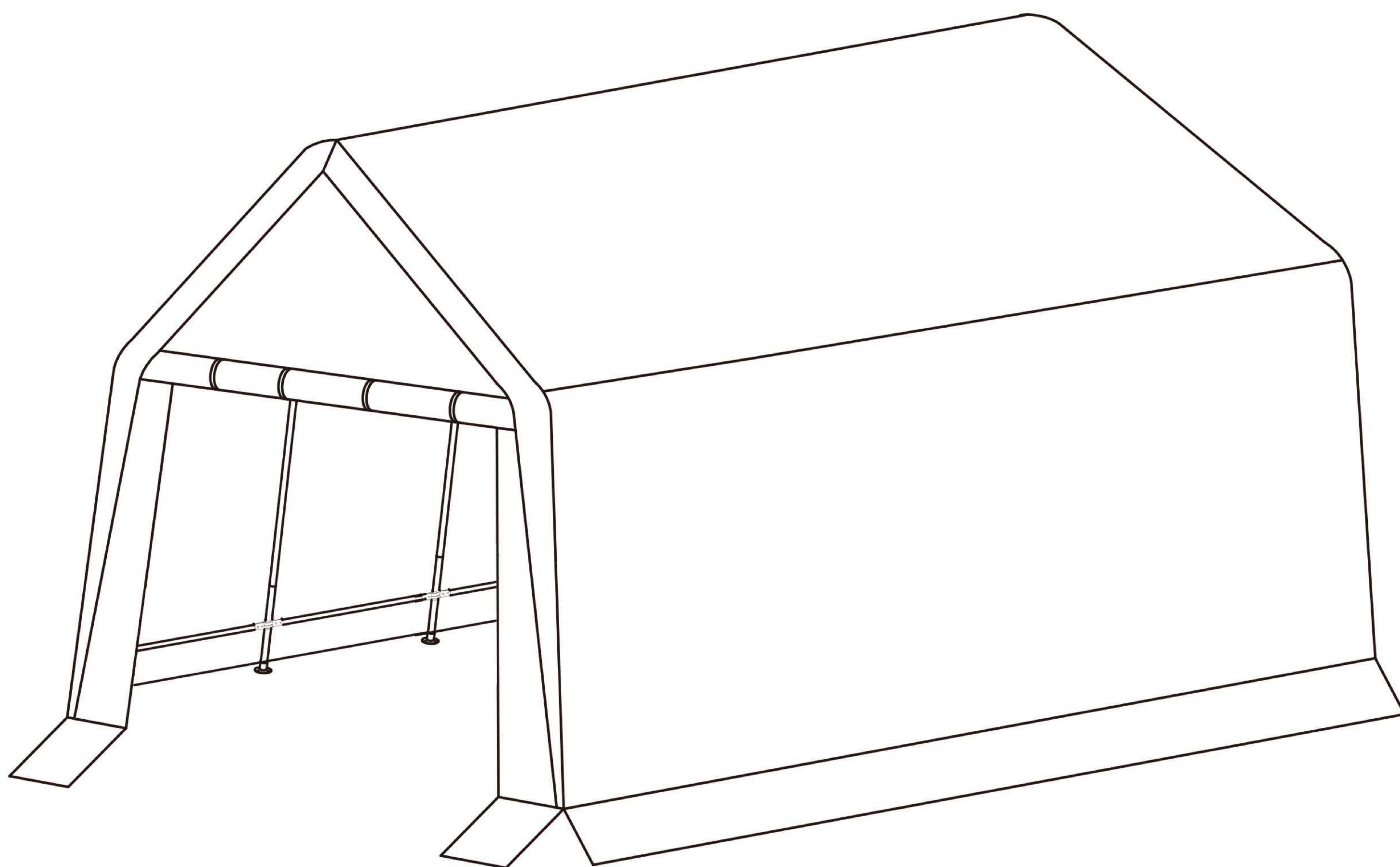

Please check the number of parts in the following accessory catalogue when unpacking. We have sent you more small parts for spare. If there is any missing or any questions about the installation. Please feel free to contact us. We will reply within 24 hours.



E-mail: cs.helper01@gmail.com

TOOLS RECOMMENDED

*NOTE: The recommended tools are not included in boxes and need to be prepared by yourself.

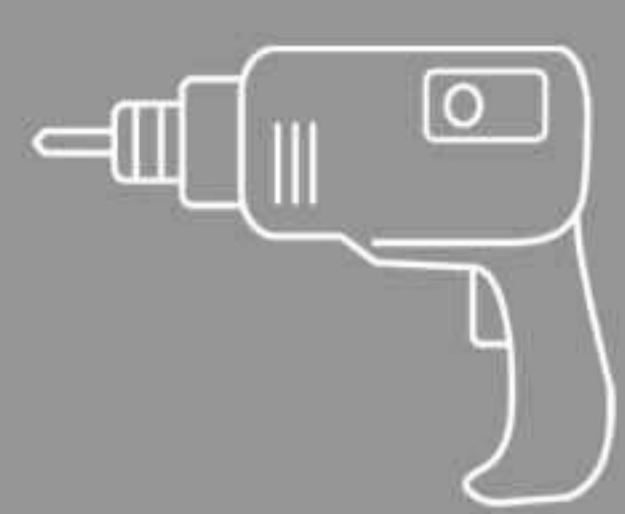

DRILL



RUBBER Mallet



STEPLADDER
(6.5Ft Or More)



SAFETY HAT



GLOVES

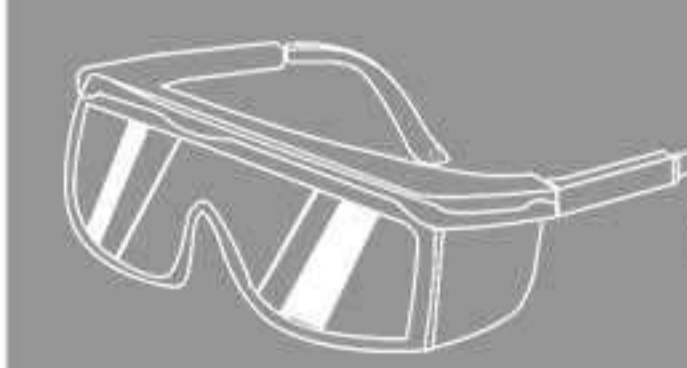

SAFETY GOGGLES

ATTENTIONS



Since it is easy to lose many small accessories during the installation, please collect all the screw accessories before the assembly is completed



To better align the screws for practical situations, do not fully tighten screws initially



Please reinforced the Gazebo and do not use in heavy winds or inclement weather



Make sure all screws are tightened before use and check all screws, buckles and straps every 90 days



Two or more people are required for assembly



Please clear the snow off the roof in time for the heavy snowfall and do not use it









Please take care of the screws and contact the after-sales service if there is any problem with the installation or parts.



ACCESSORY CATALOGUE

BOX 1

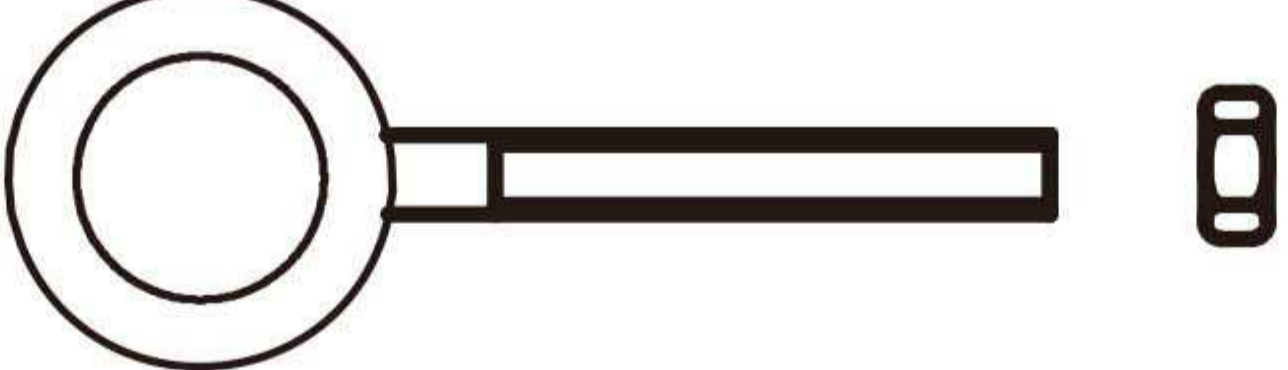



SKU: E002G069-1

Item no.	Reference Image	Qty.
1		12
2		15
3A		12
4		10
D1		4
E		40
F	 M8x50	4
G	 M8x50	60
H	 M6x45	40

Please take care of the screws and contact the after-sales service if there is any problem with the installation or parts.

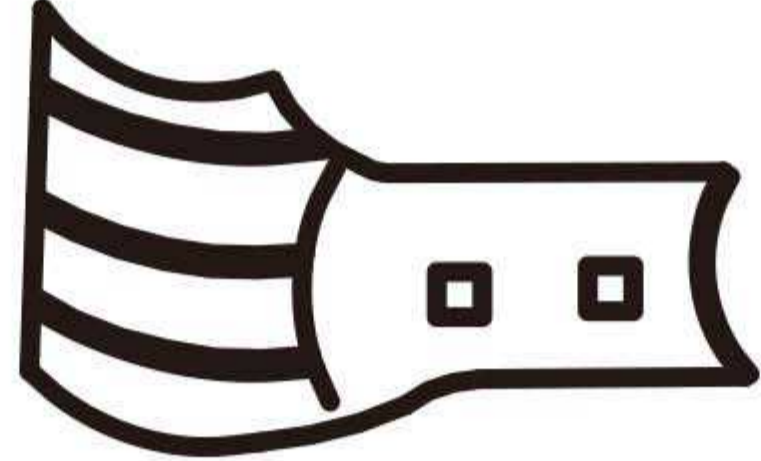
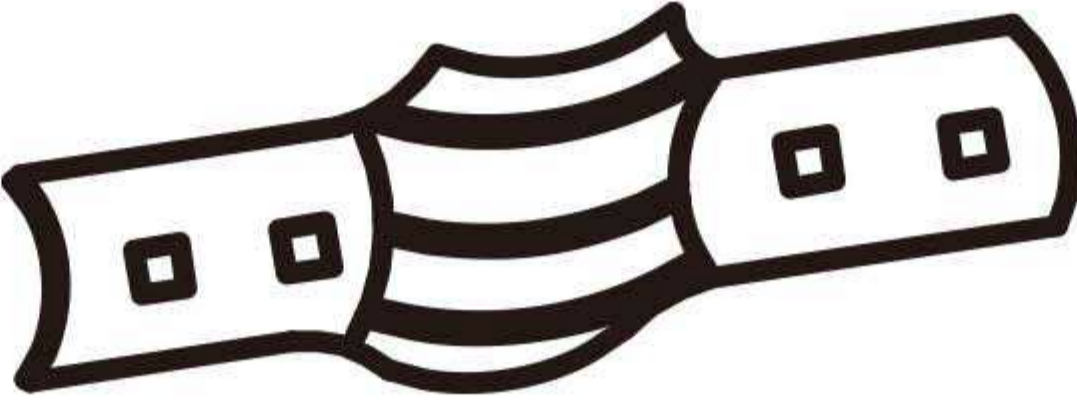
➔ ✉ E-mail: cs.helper01@gmail.com

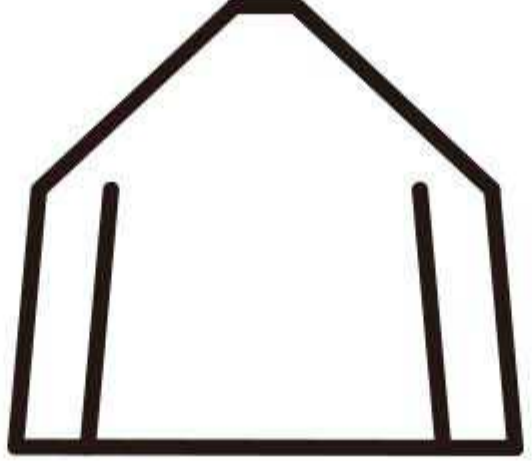
ACCESSORY CATALOGUE

Item no.	Reference Image	Qty.
I	 M8x50	8
J		8
K		16
M	 $\phi 5.8$	24
O		2
Q	 M8	16
D		4



BOX 2

SKU: E002G069-2

Item no.	Reference Image	Qty.
1A		24

Please take care of the screws and contact the after-sales service if there is any problem with the installation or parts.

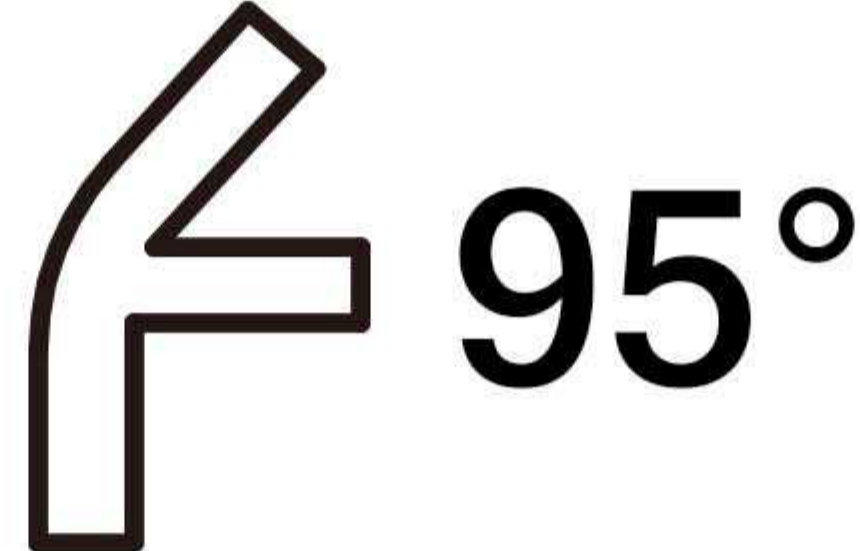
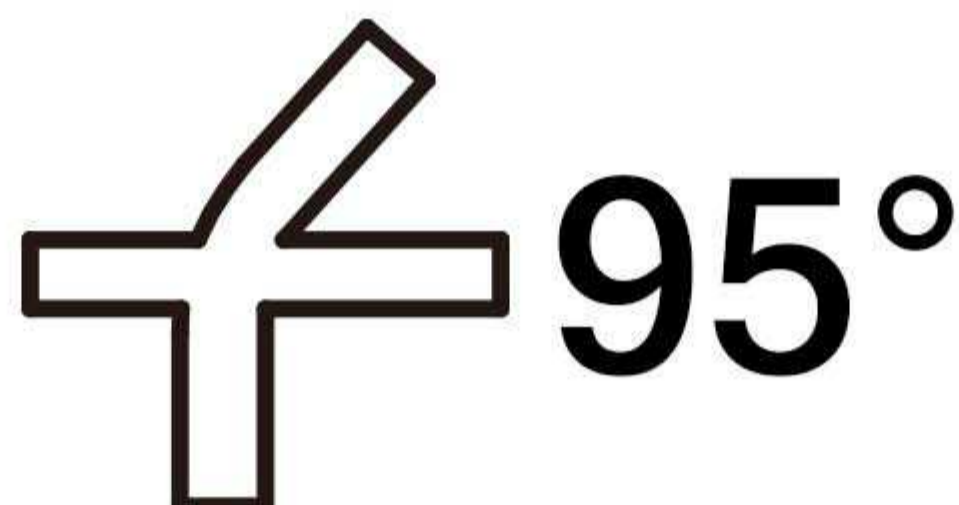
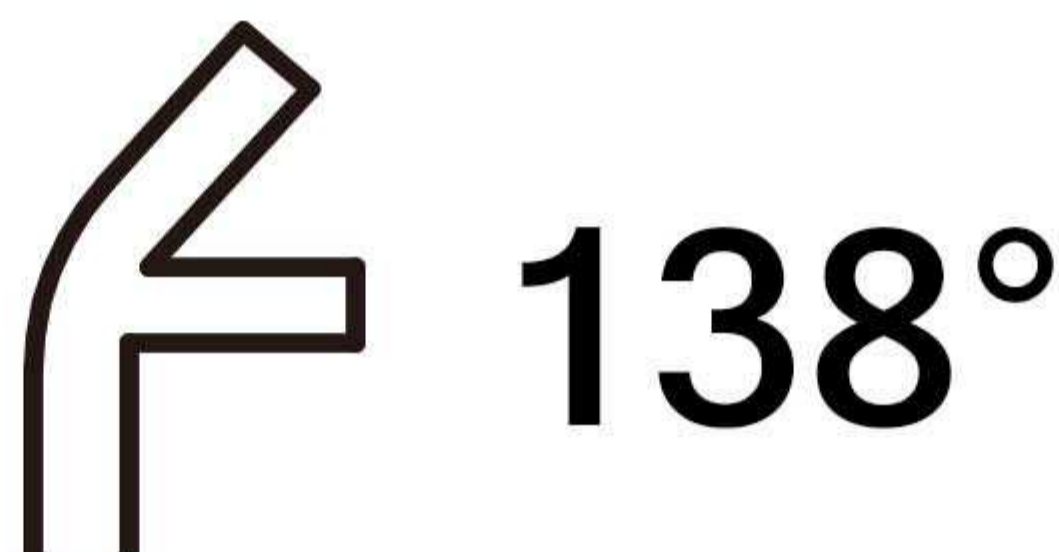
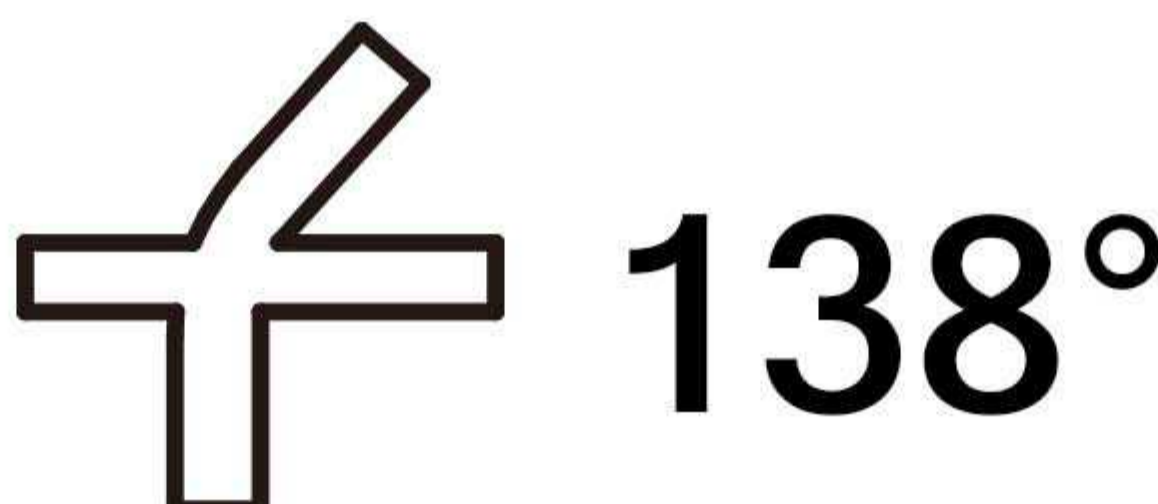
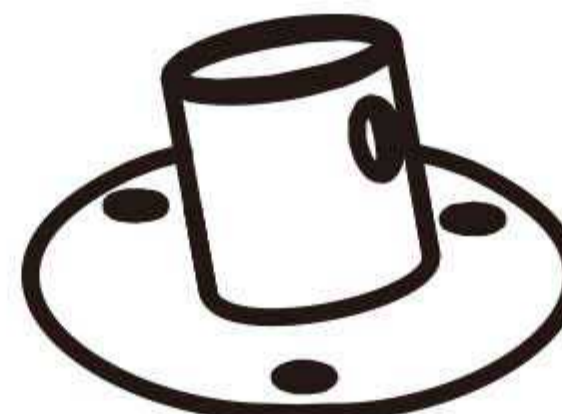
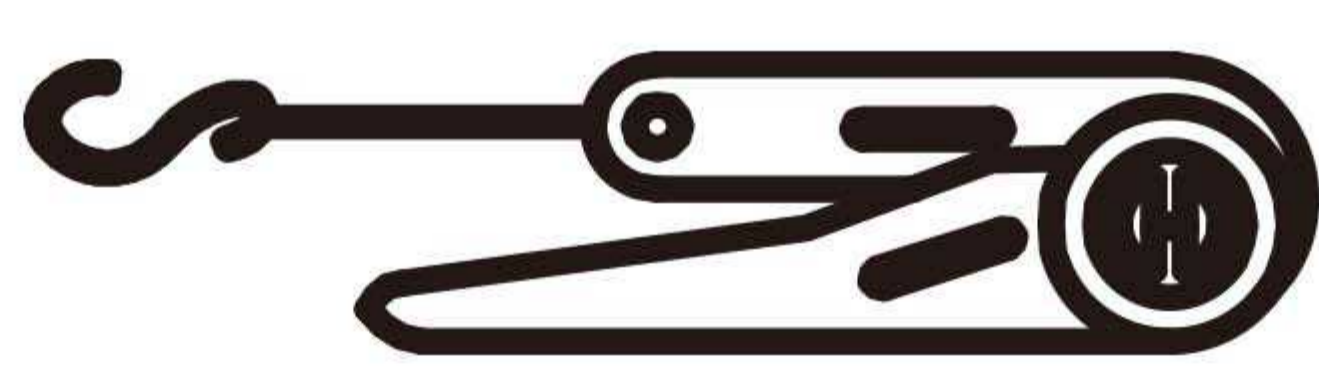
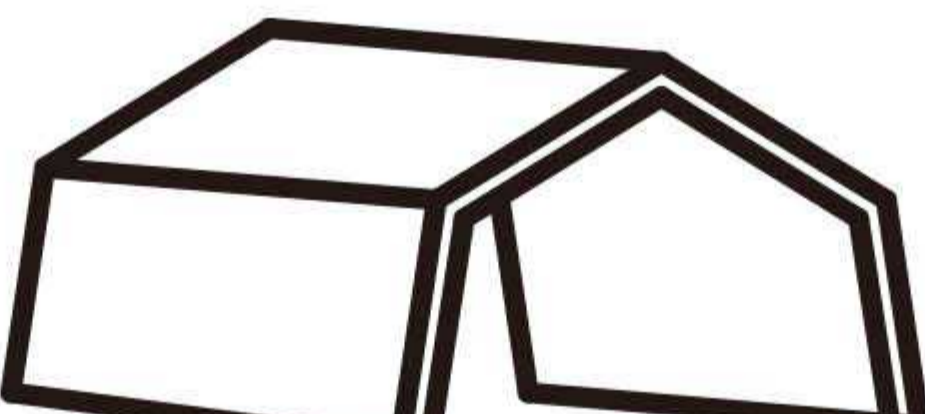
ACCESSORY CATALOGUE

Item no.	Reference Image	Qty.
A	 95°	2
B	 95°	4
A1	 138°	4
B1	 138°	8
C		12
L		4
N		1
5		6

Please take care of the screws and contact the after-sales service if there is any problem with the installation or parts.

➔ ✉ E-mail: cs.helper01@gmail.com

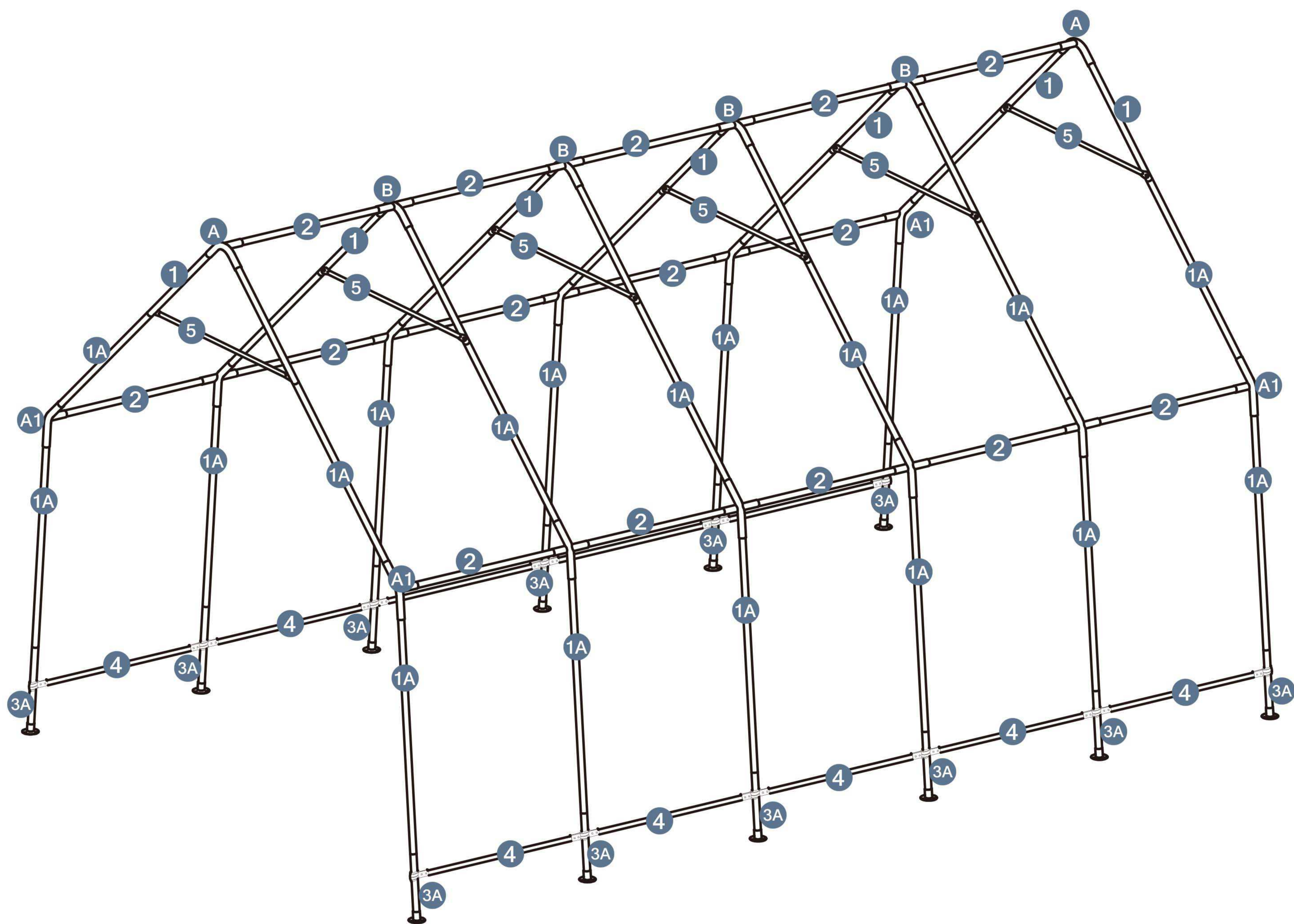

Please take care of the screws and contact the after-sales service if there is any problem with the installation or parts.

5

➔ ✉ E-mail: cs.helper01@gmail.com

STEP 1

Parts required

 95° **A** 2pcs

 138° **B1** 8pcs

 138° **A1** 4pcs

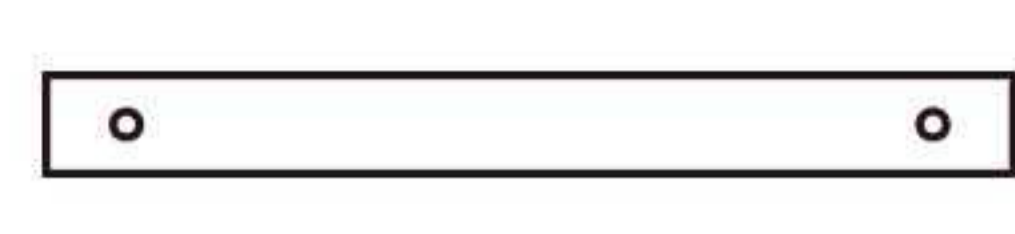
 **2** 15pcs

 **1A** 12pcs

 95° **B** 4pcs

 **1** 12pcs

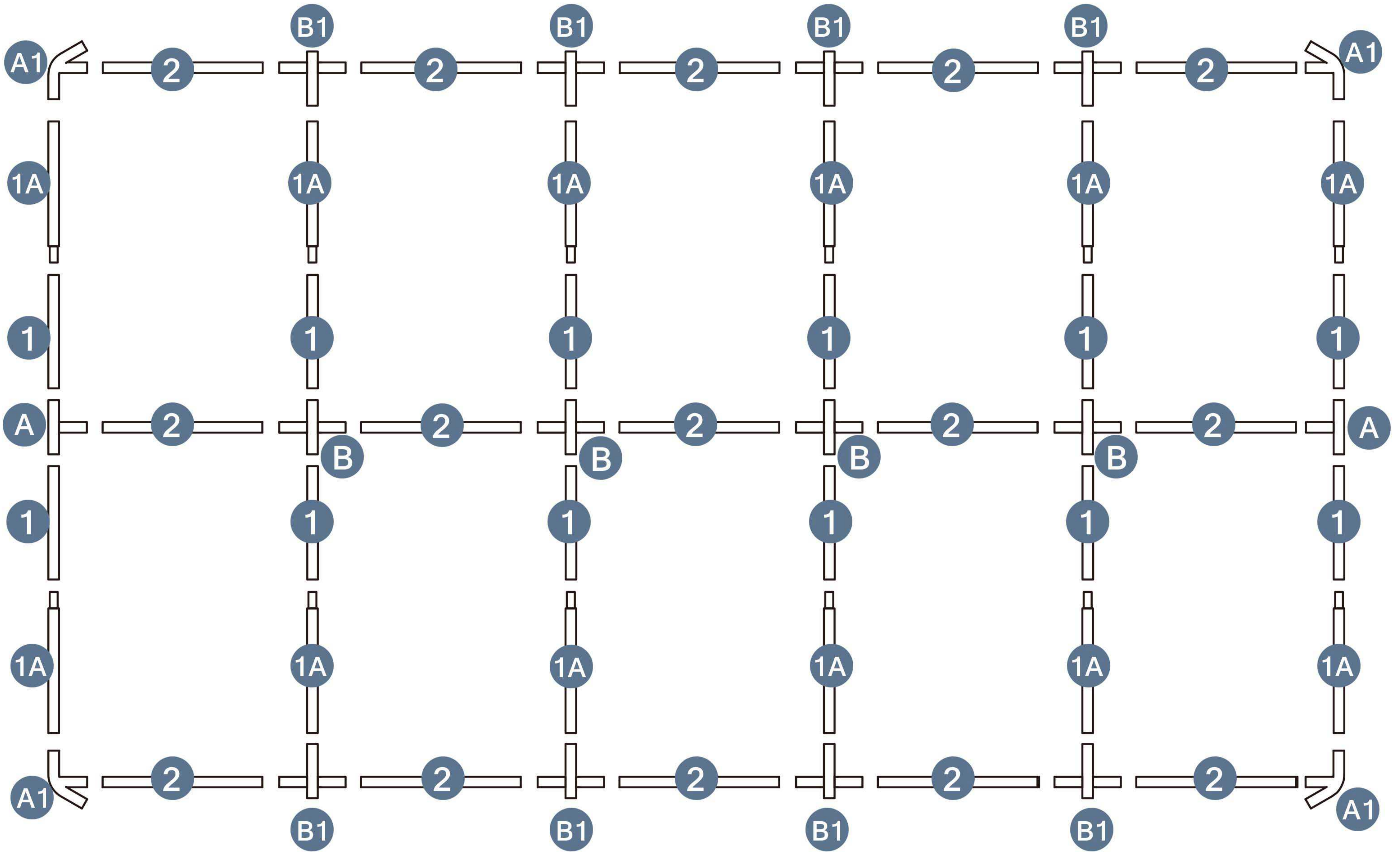

For the convenience of installation, arrange it as shown in the figure.

Please take care of the screws and contact the after-sales service if there is any problem with the installation or parts.

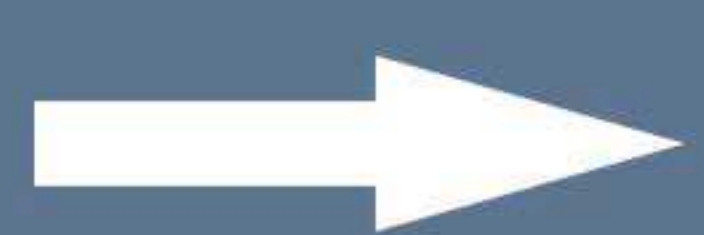

E-mail: cs.helper01@gmail.com

STEP 2

Parts required

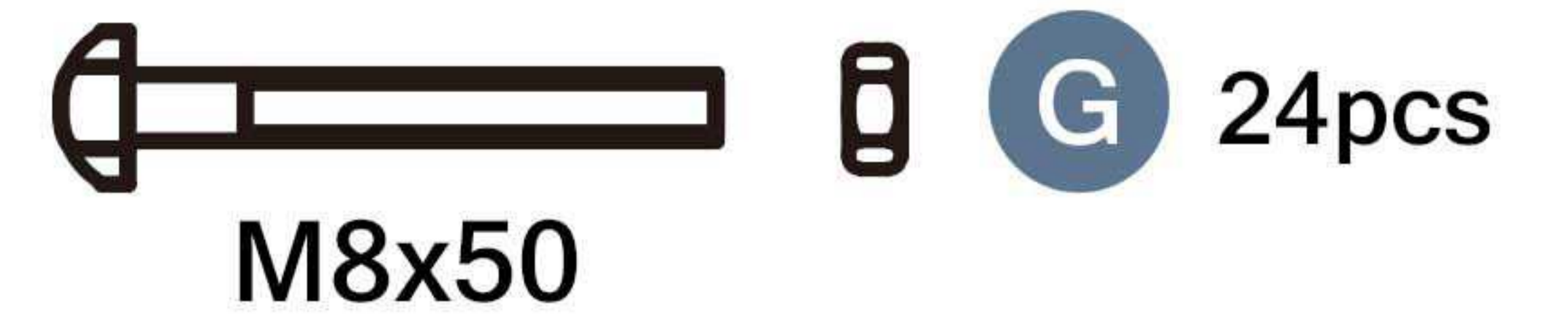

M8x50

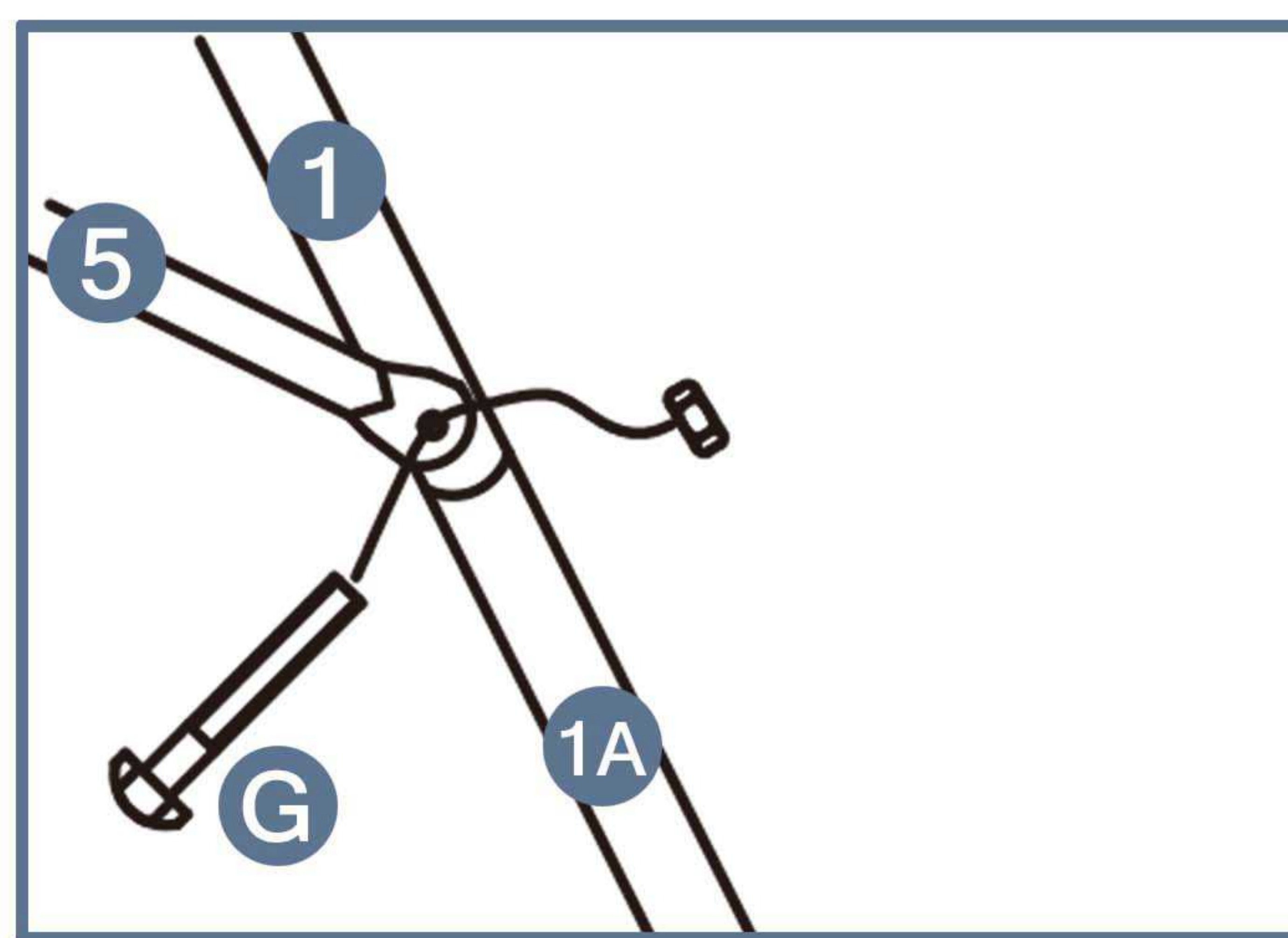
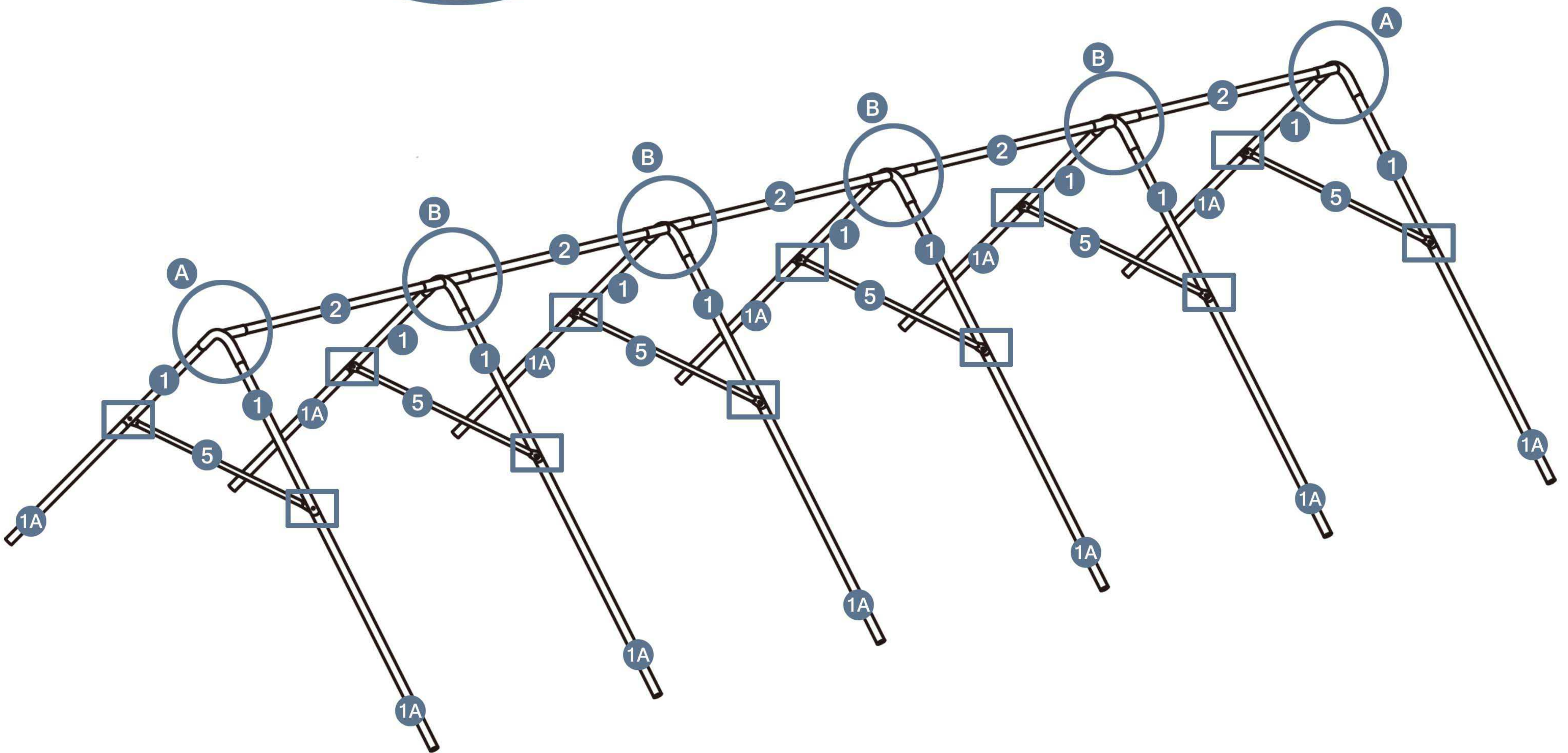
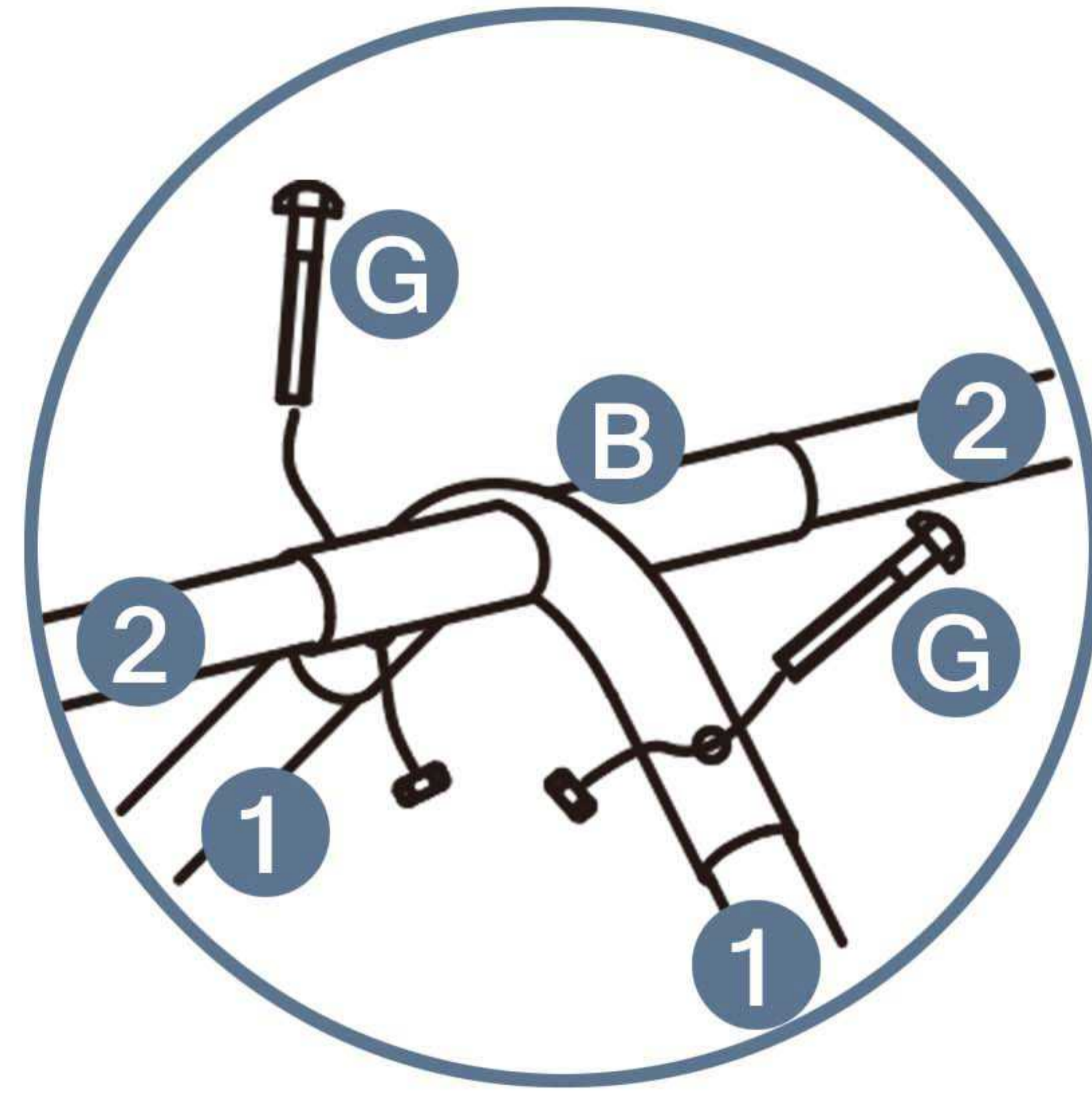
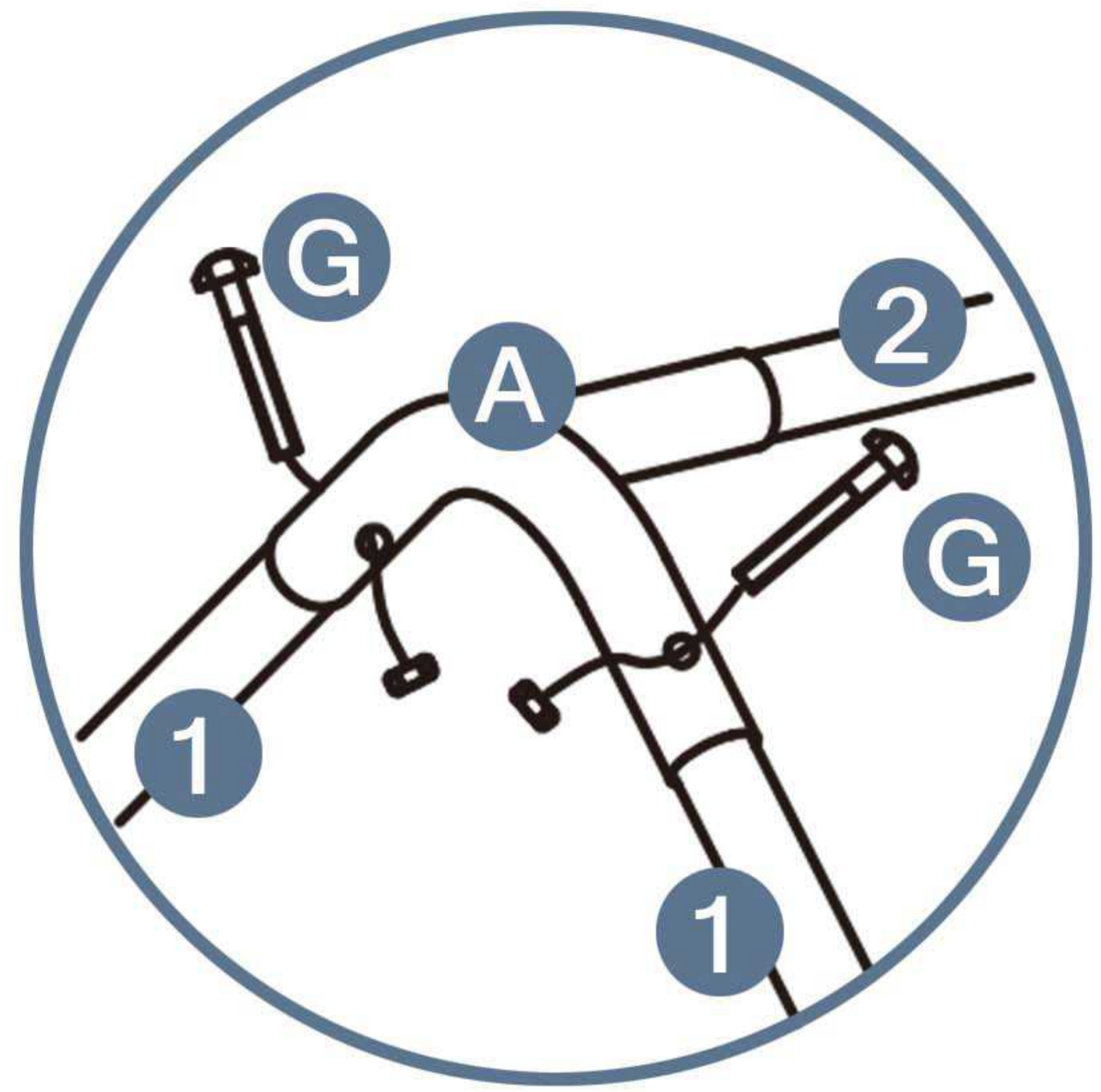

Please take care of the screws and contact the after-sales service if there is any problem with the installation or parts.



STEP 3

Parts required

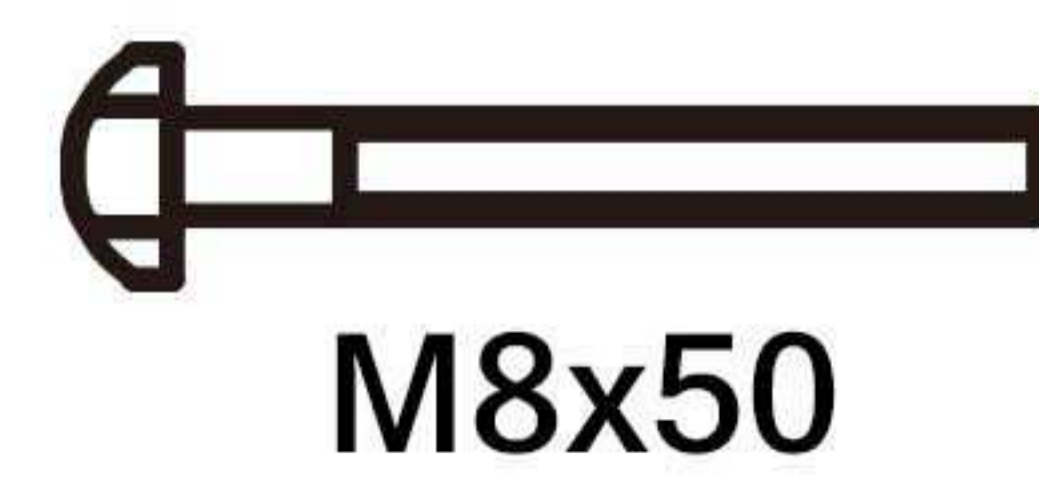

12pcs

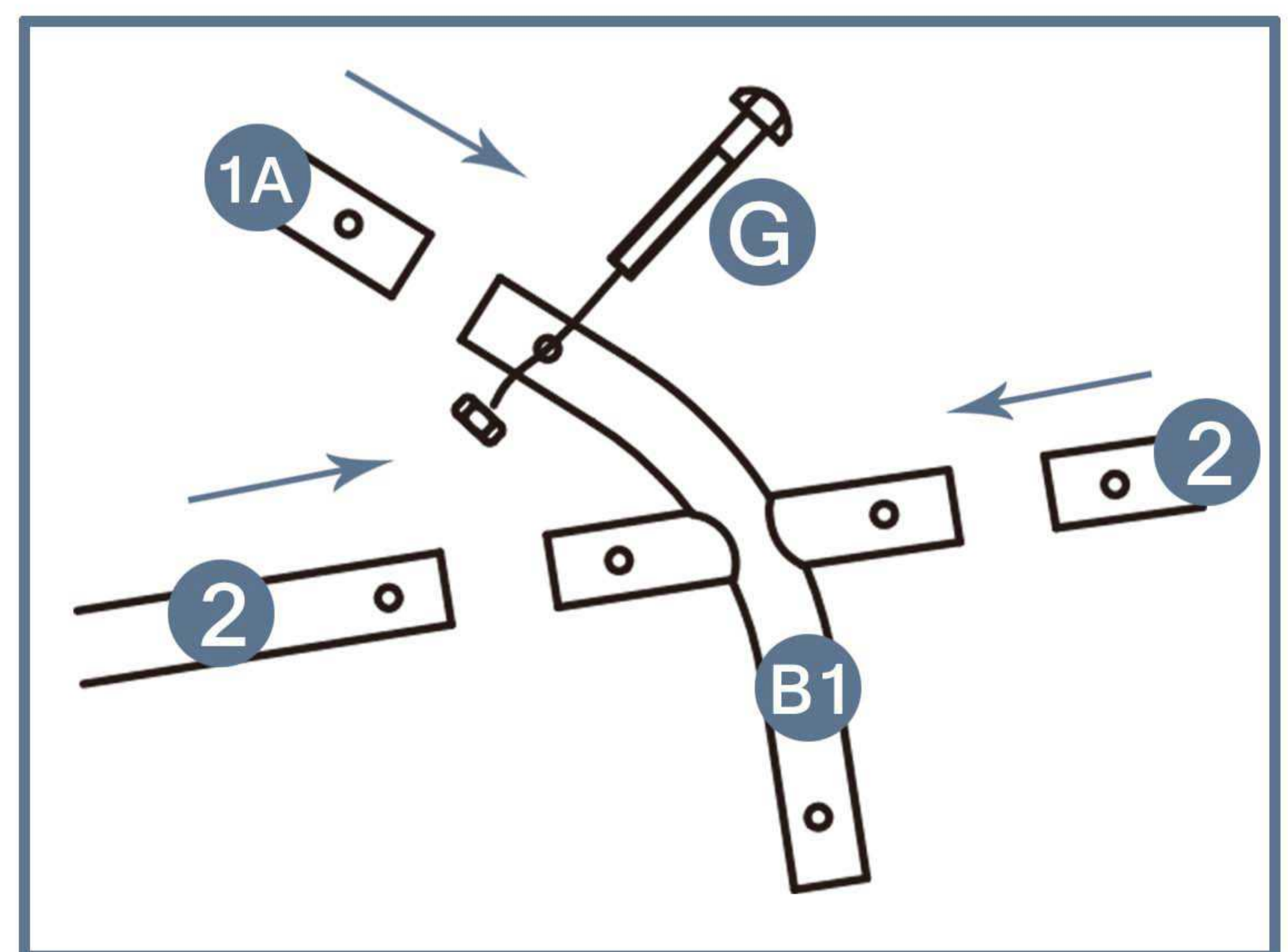
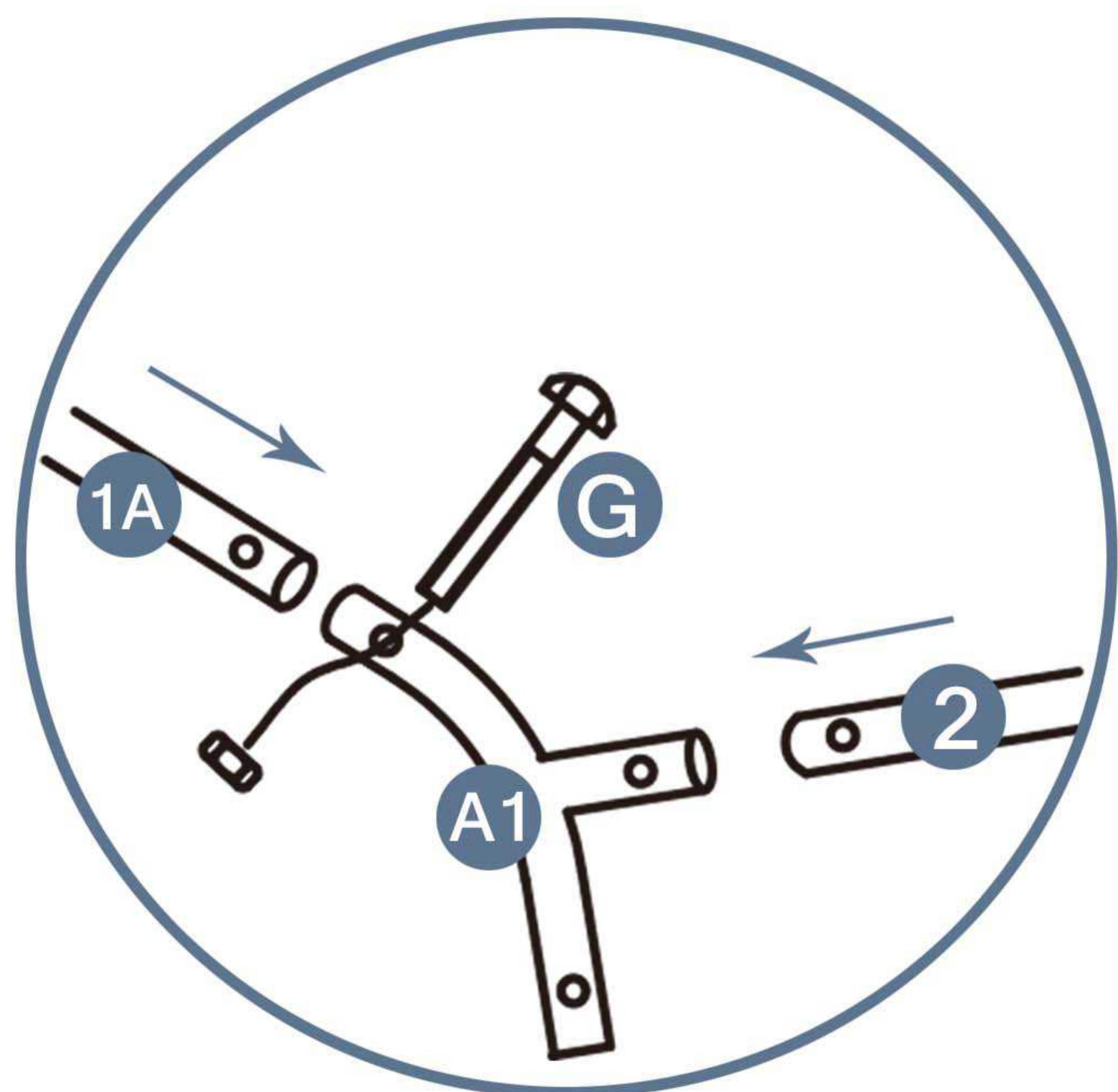
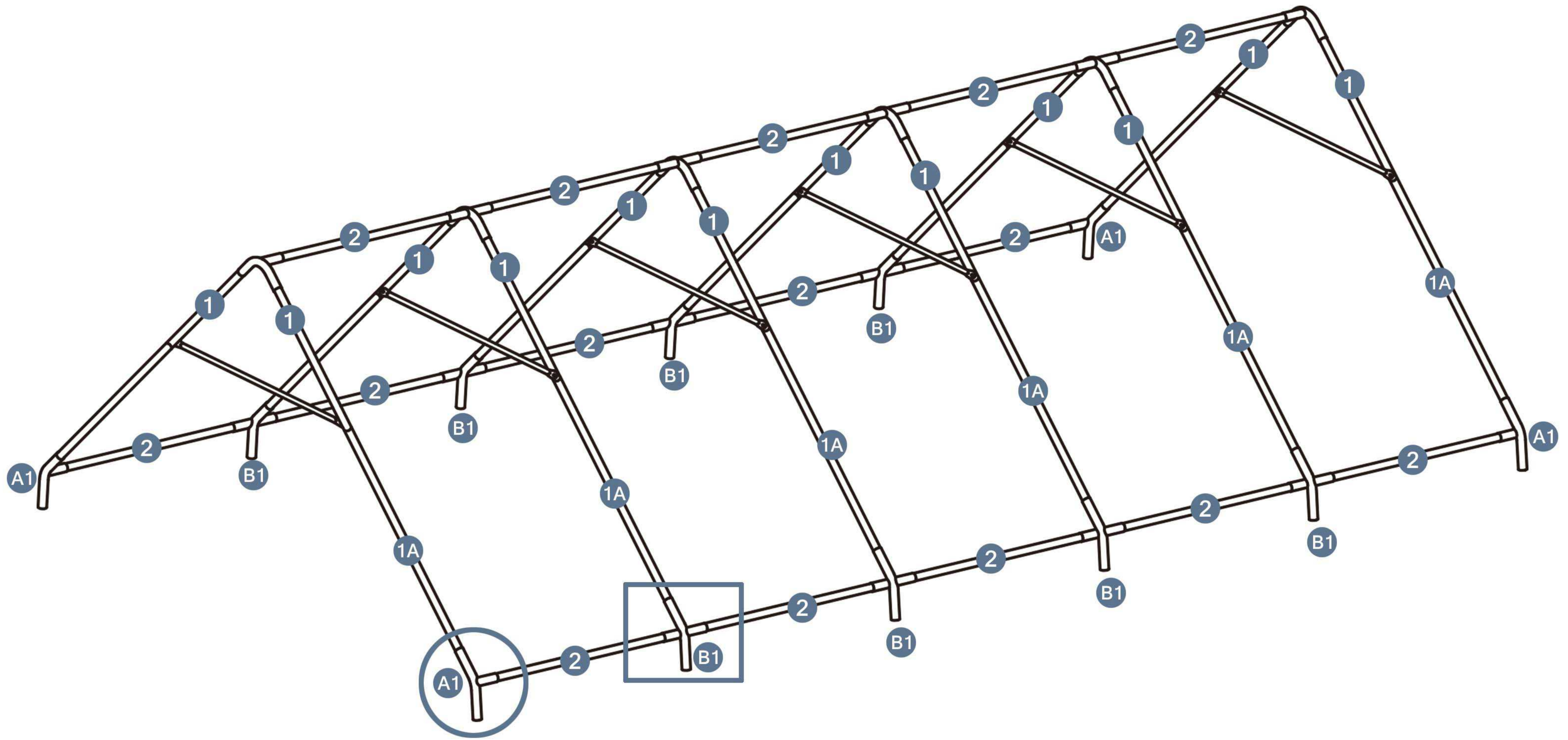

Please take care of the screws and contact the after-sales service if there is any problem with the installation or parts.



E-mail: cs.helper01@gmail.com

STEP4

Parts required

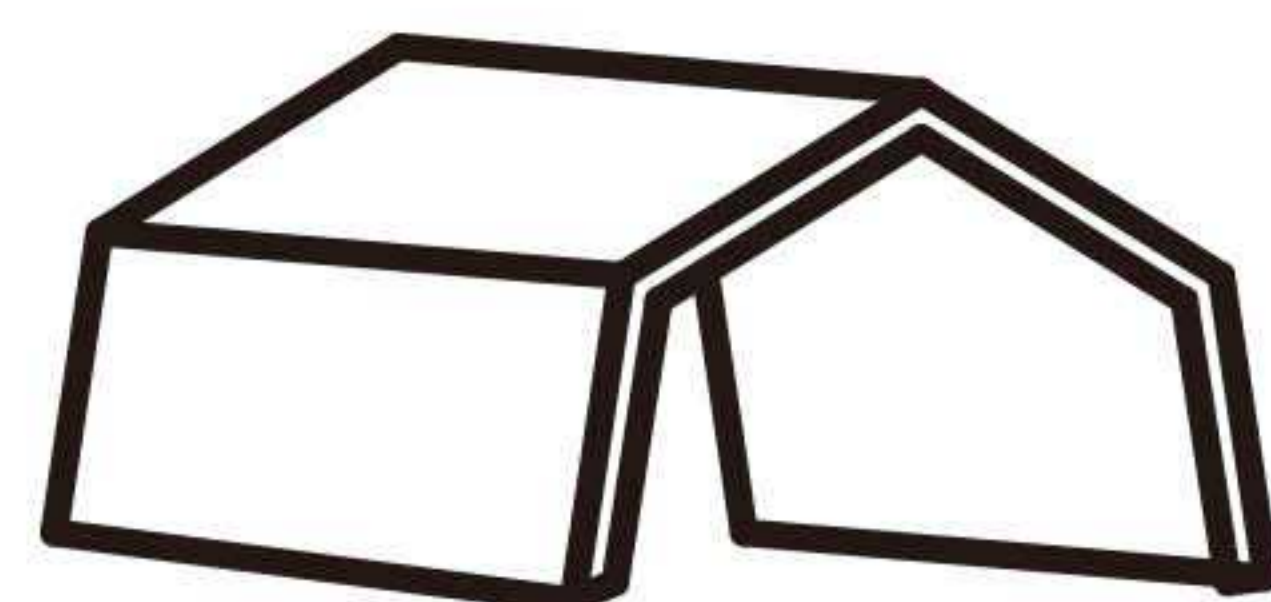

N 1pcs

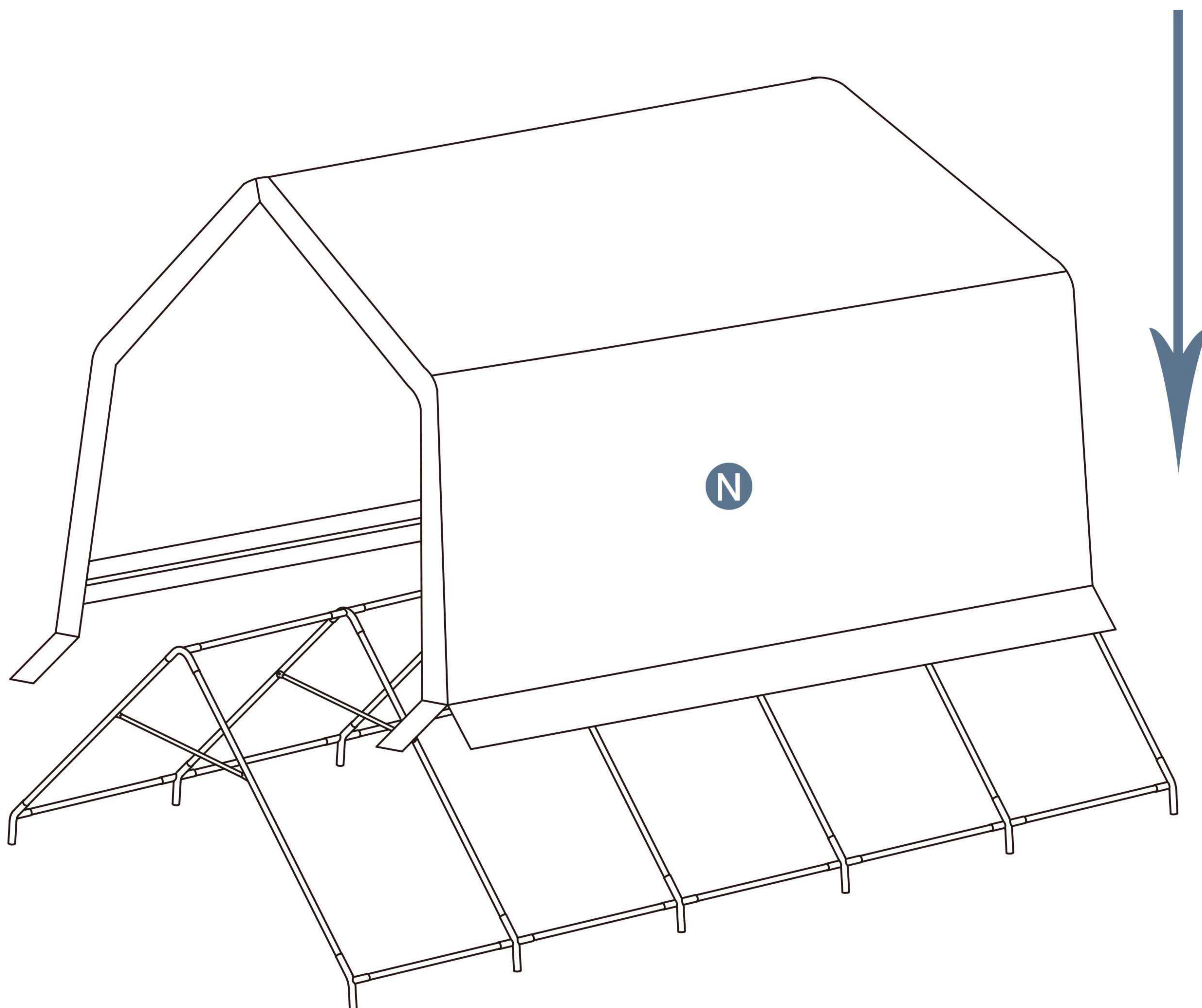

For the convenience of installation, install N first.

Please take care of the screws and contact the after-sales service if there is any problem with the installation or parts.

STEP 5

Parts required

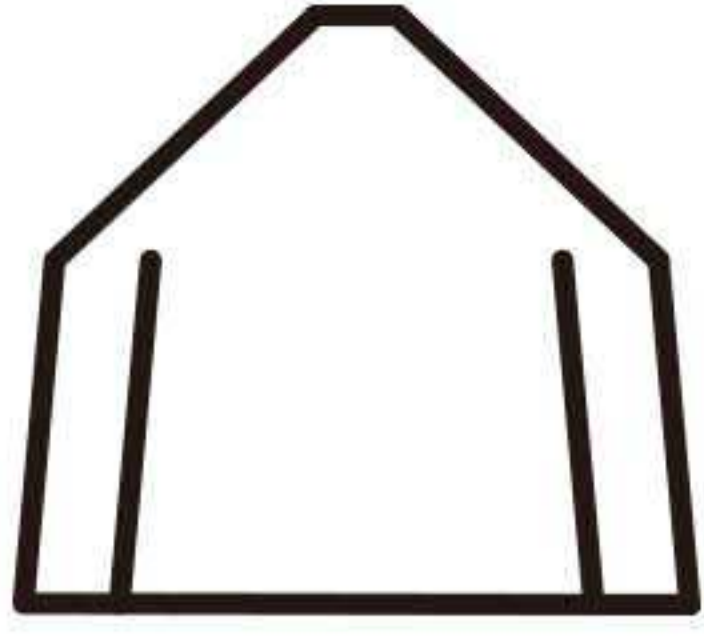

○ 2pcs

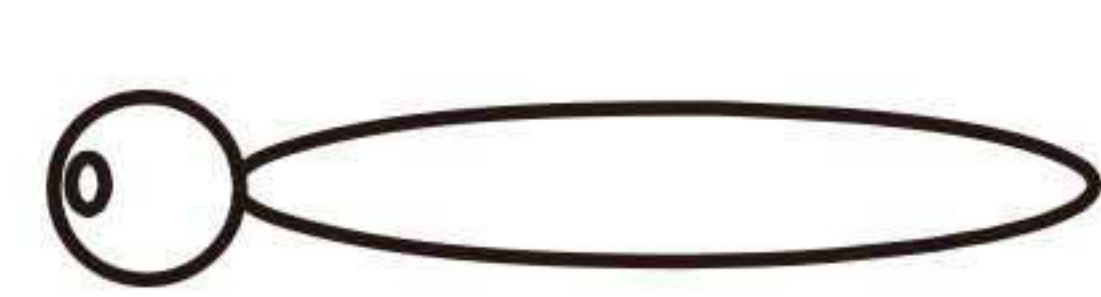

● E 20pcs

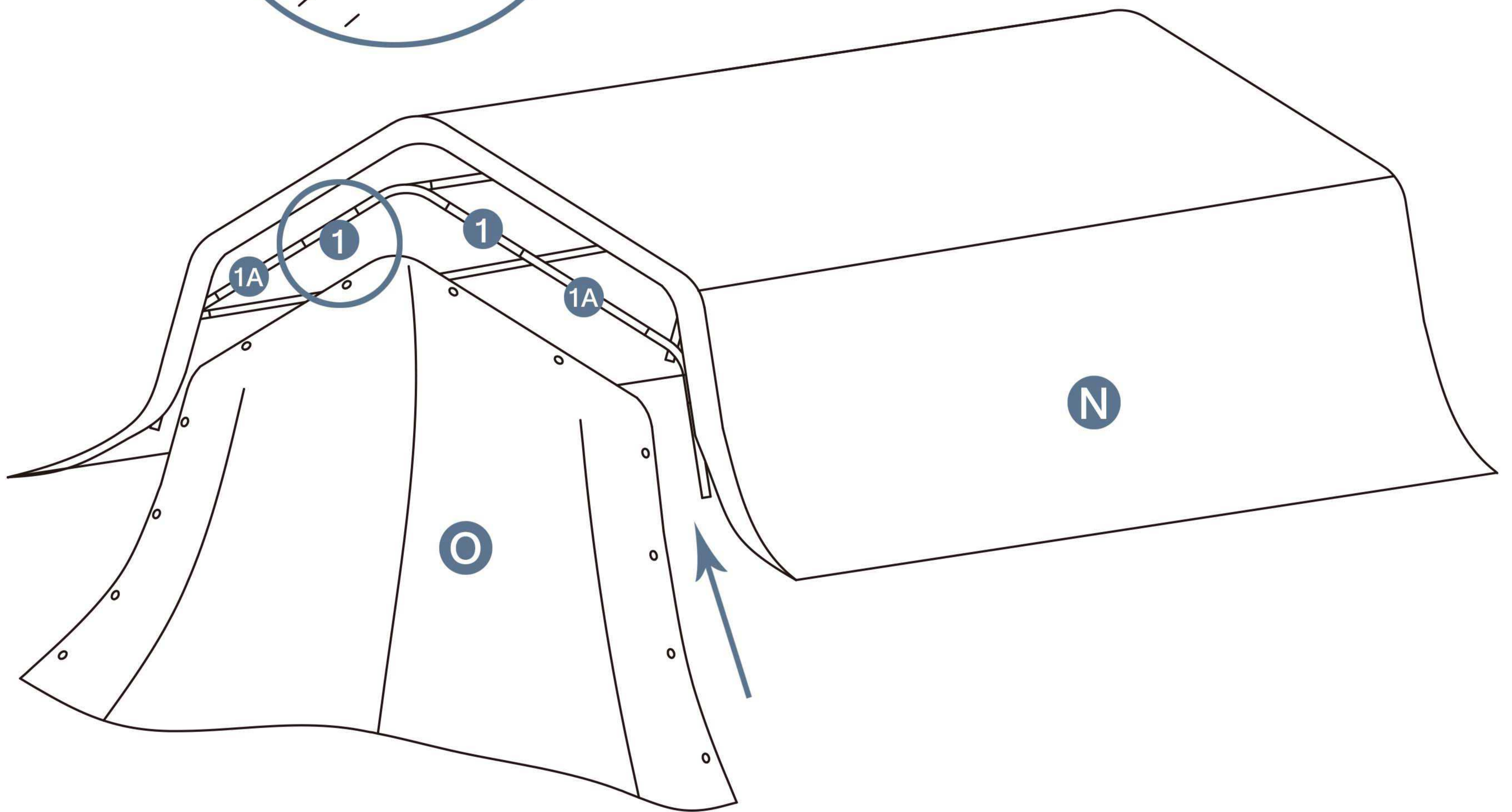
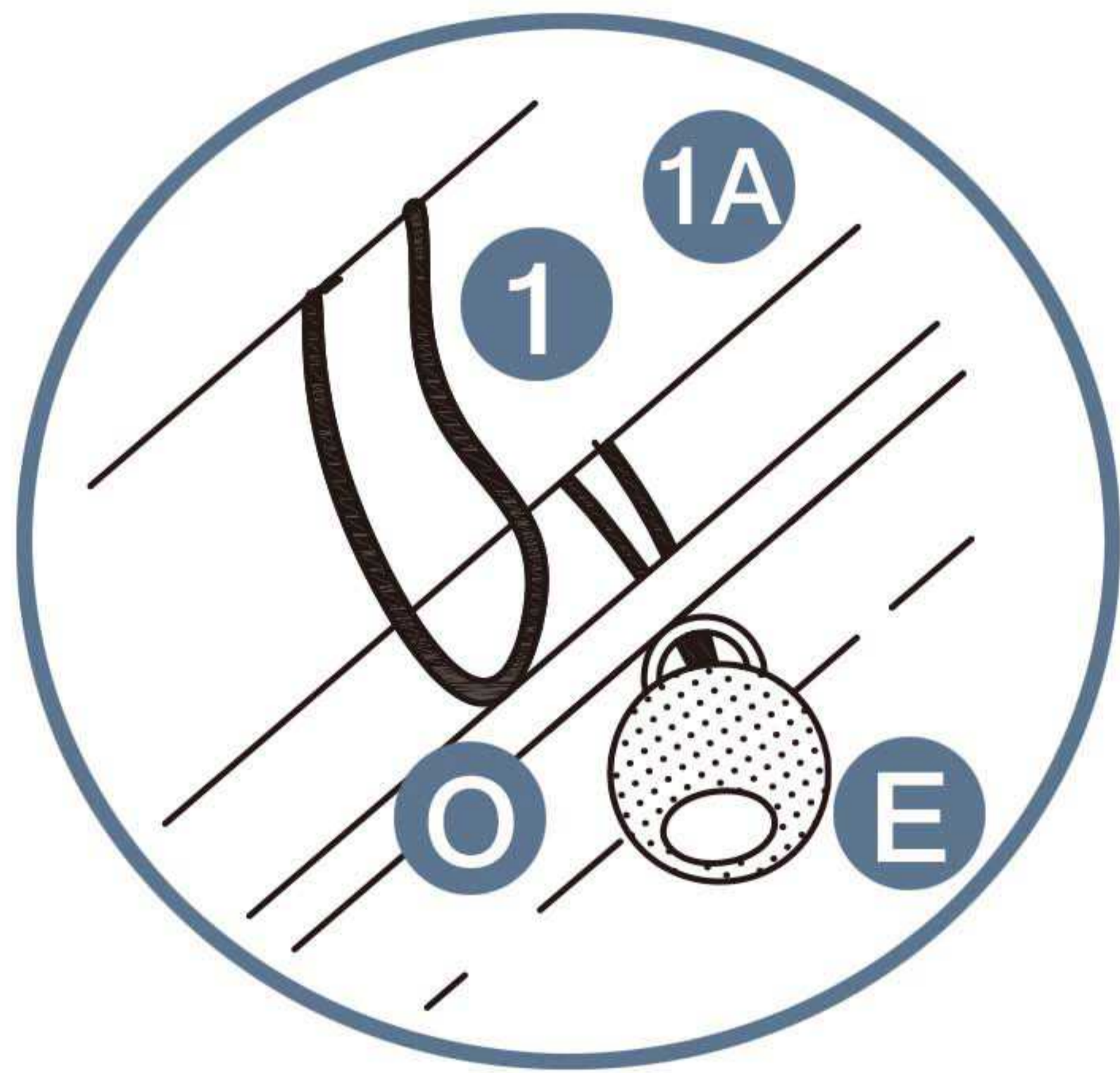

Please take care of the screws and contact the after-sales service if there is any problem with the installation or parts.

➔ ✉ E-mail: cs.helper01@gmail.com

STEP 6

Parts required

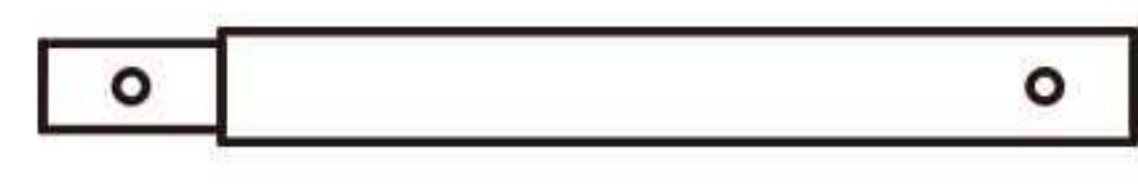

1A 12pcs



M8x50



G 12pcs

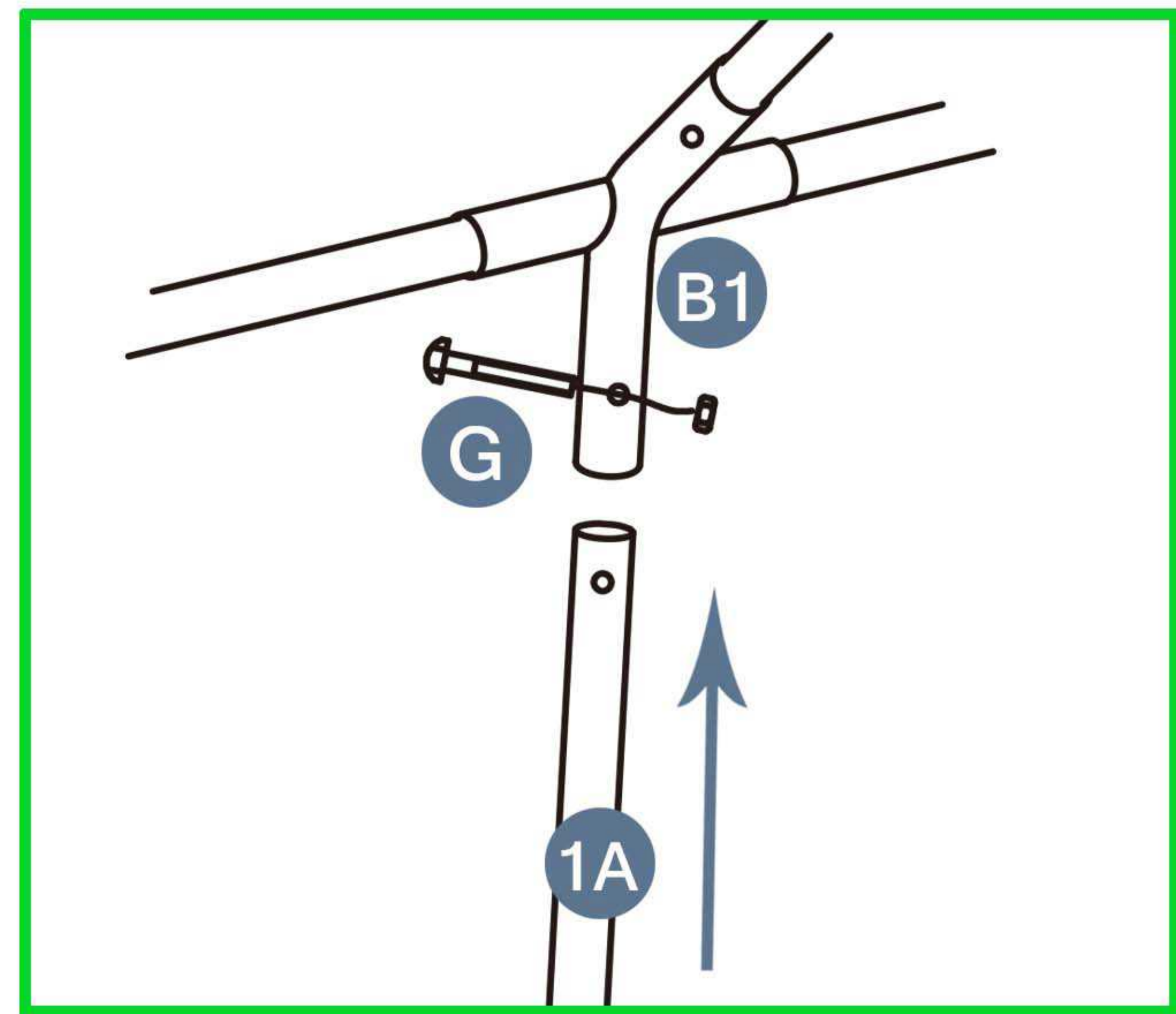
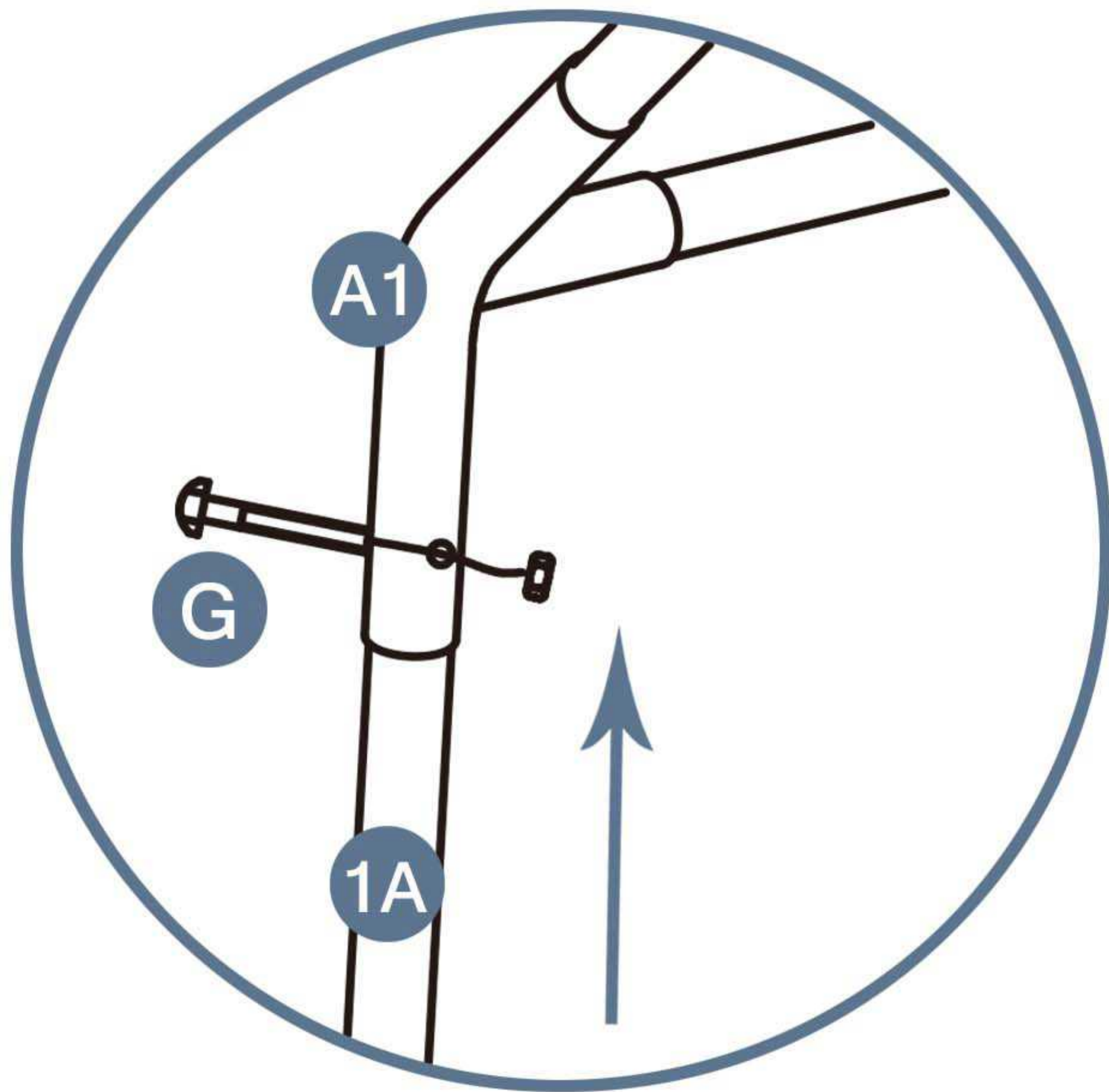
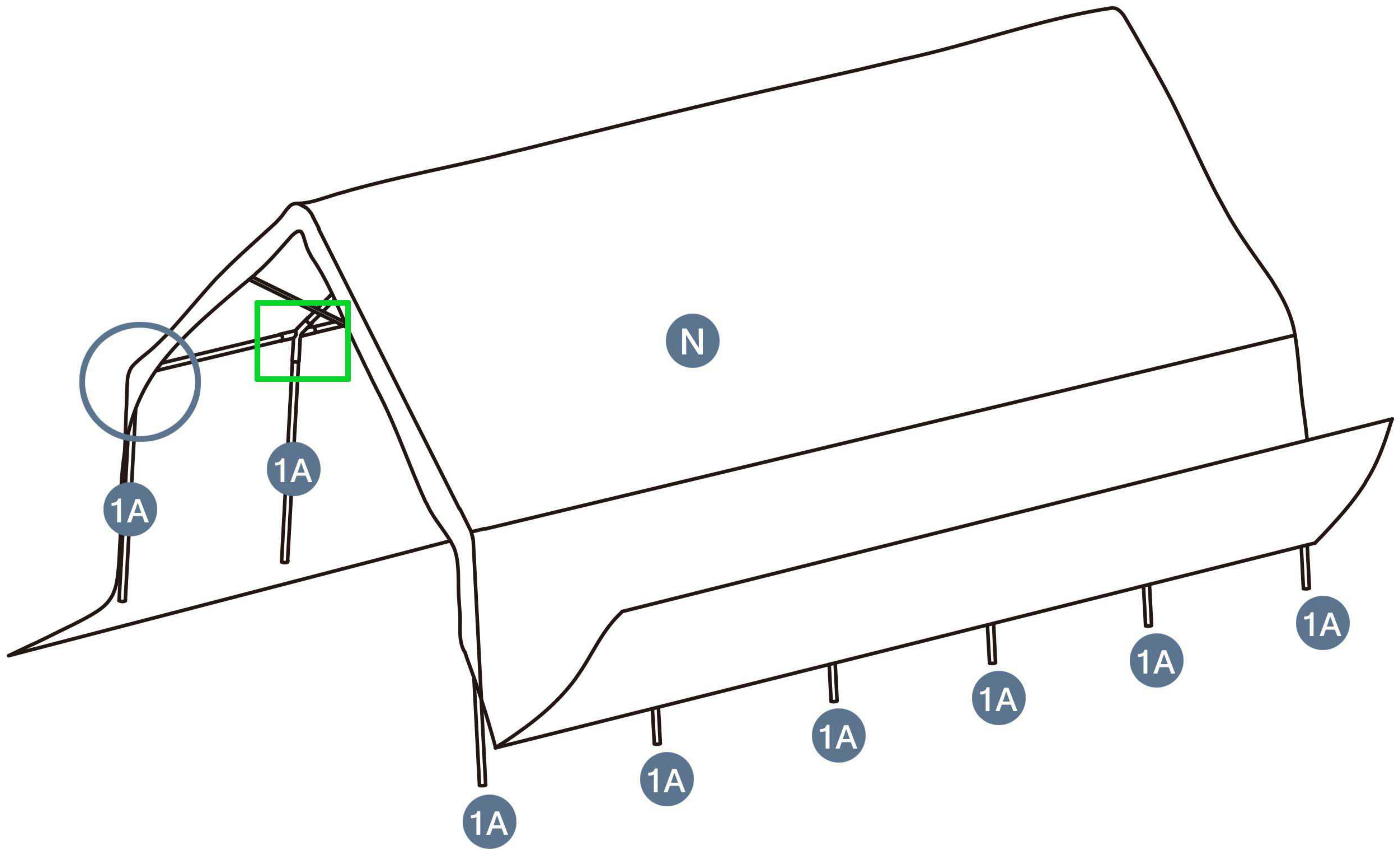

Please take care of the screws and contact the after-sales service if there is any problem with the installation or parts.

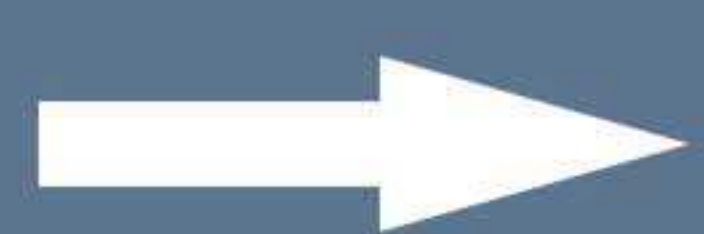

E-mail: cs.helper01@gmail.com

STEP 7

Parts required

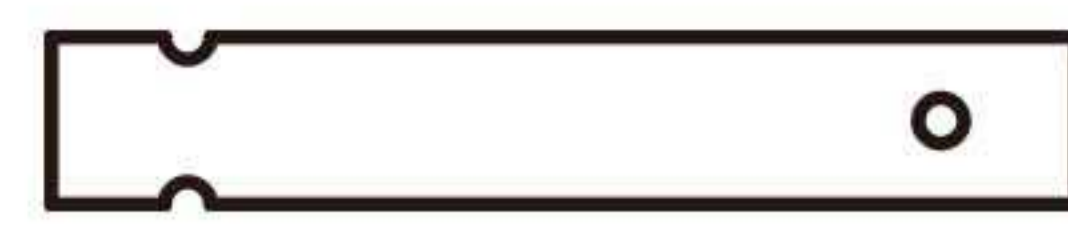

3A 12pcs



G 12pcs

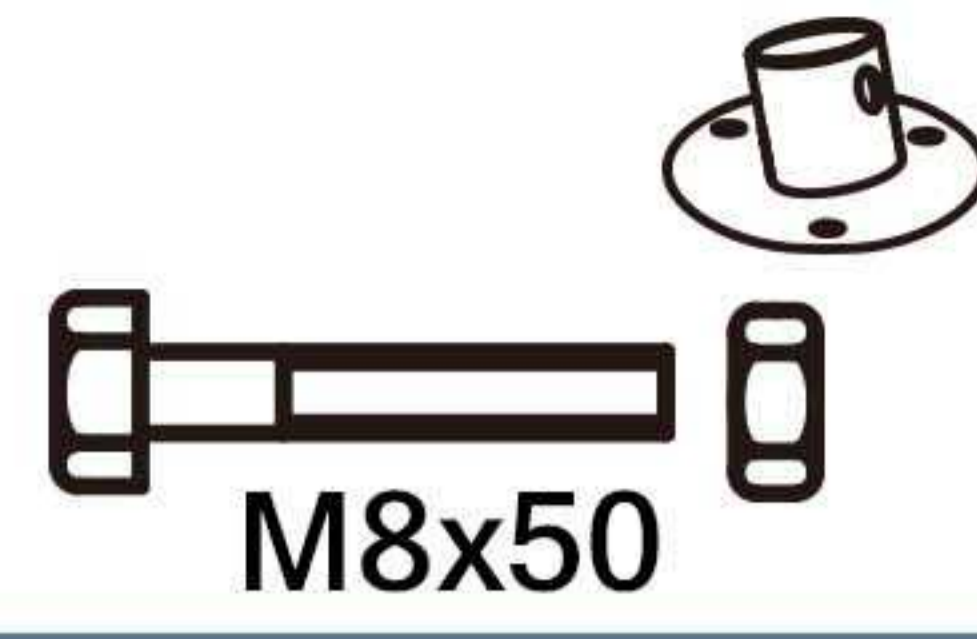

C 12pcs

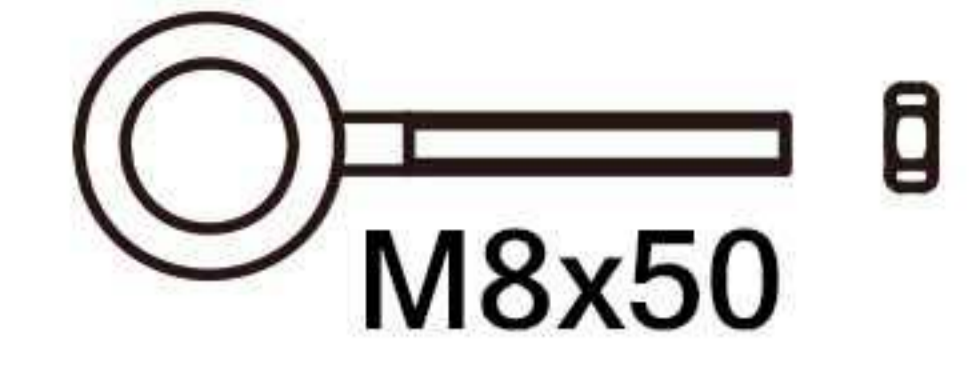

F 4pcs

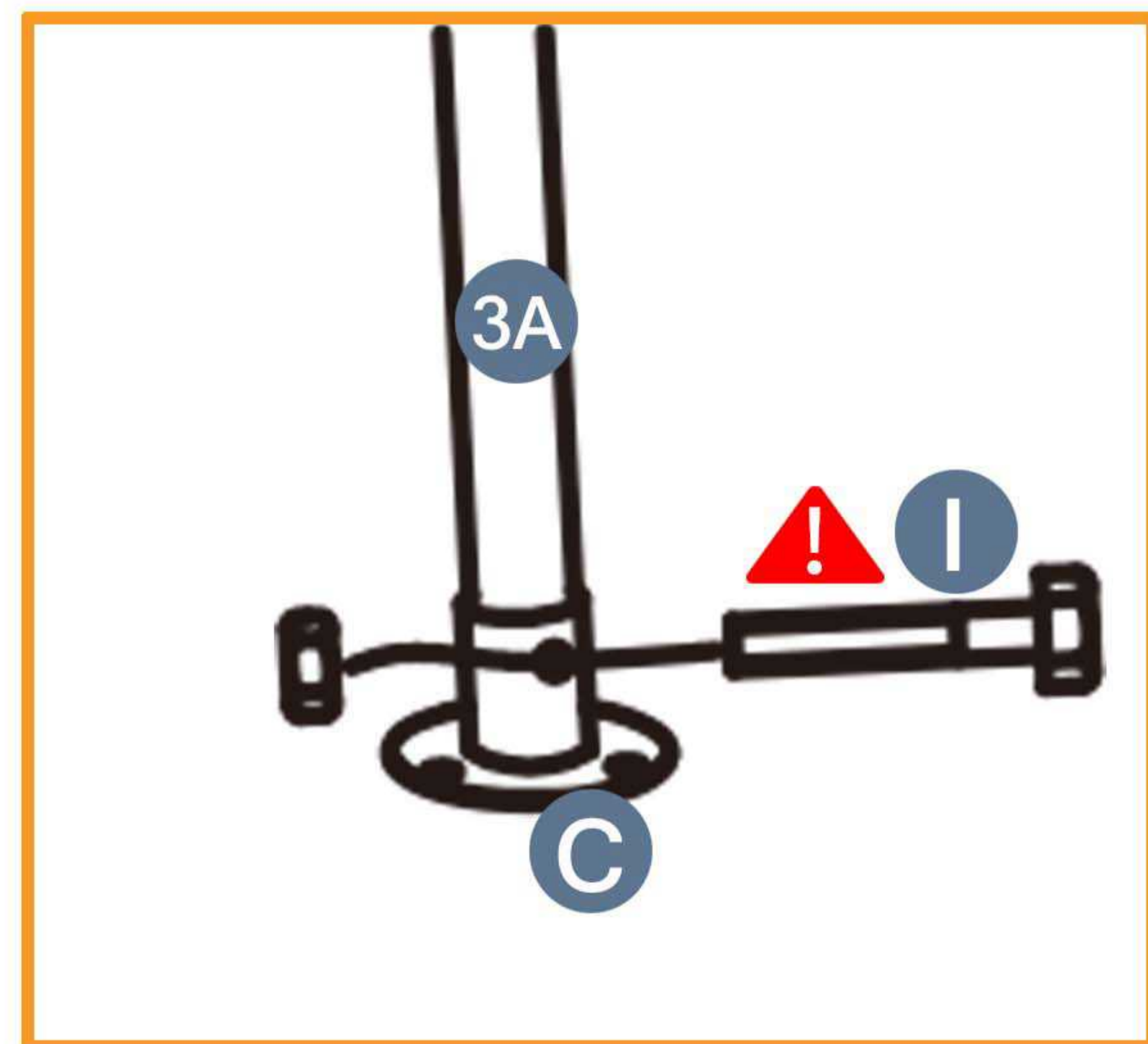
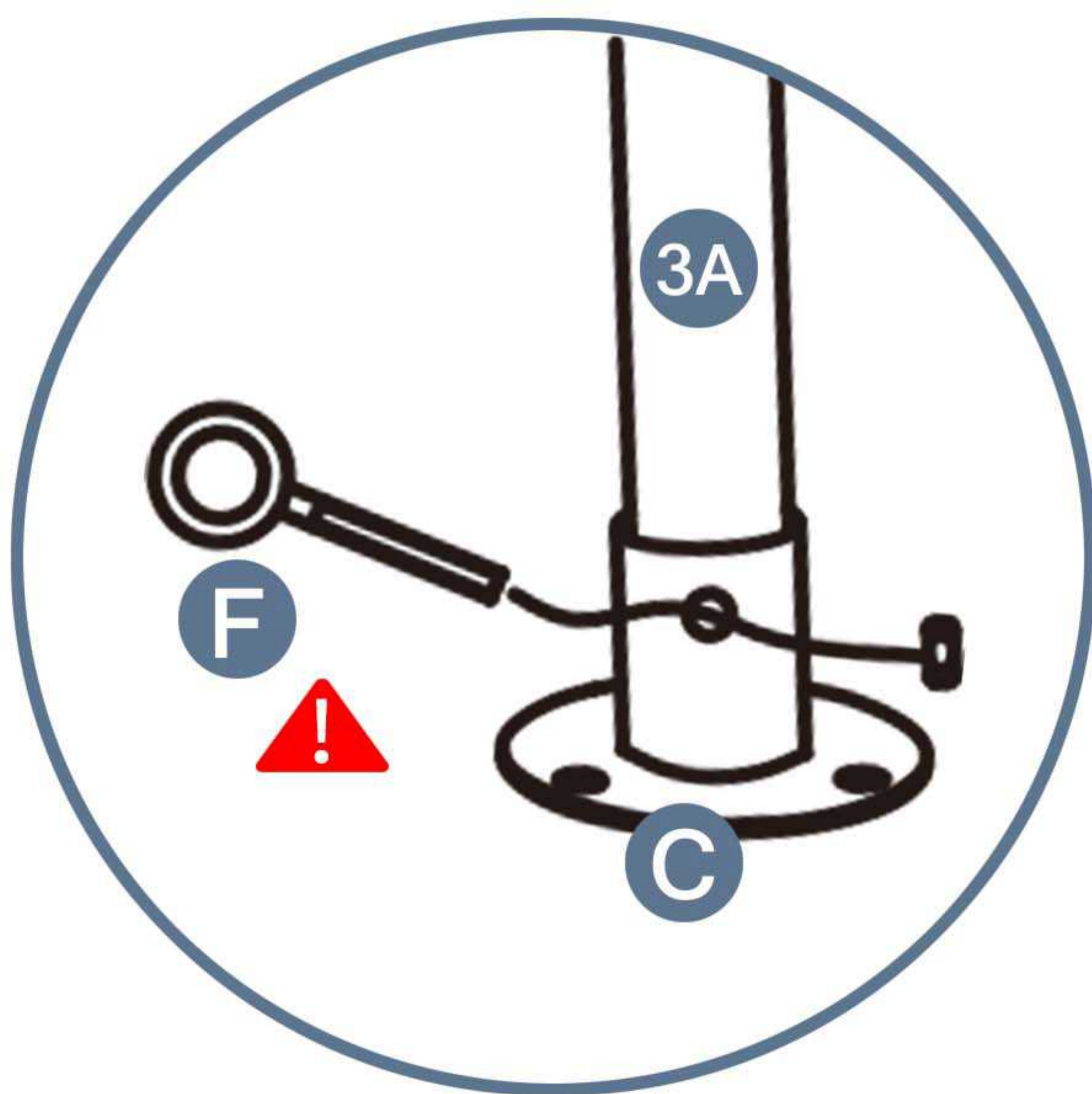
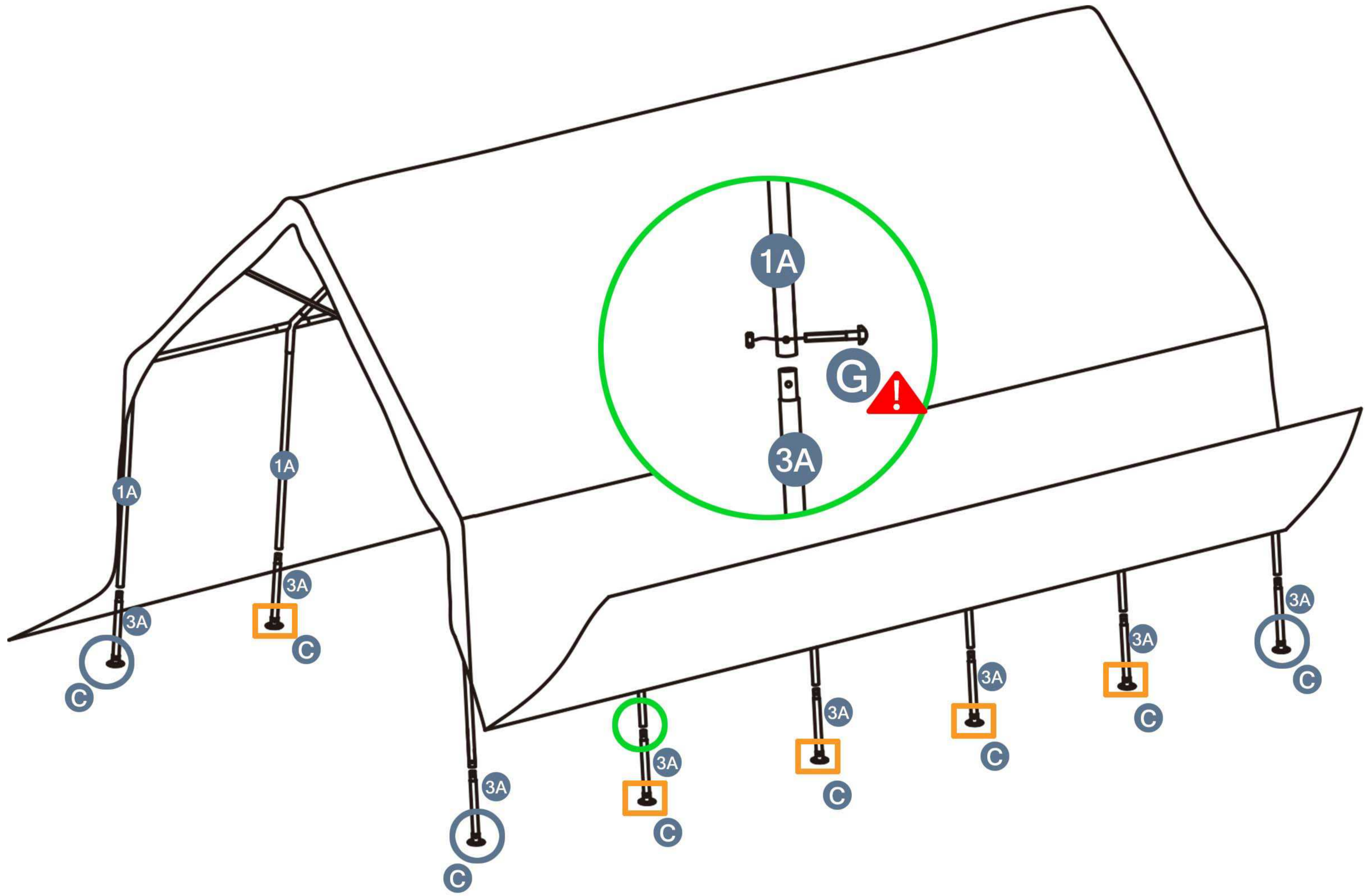

⚠ Pay attention to the difference of screws

Please take care of the screws and contact the after-sales service if there is any problem with the installation or parts.

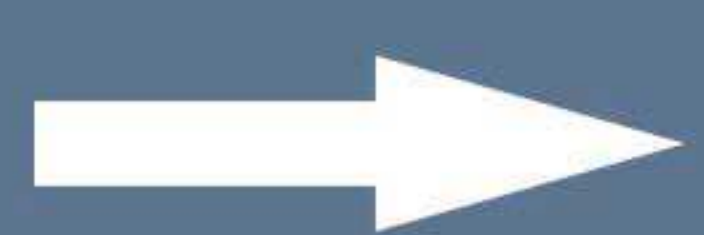

E-mail: cs.helper01@gmail.com

STEP 8

Parts required



E 20pcs

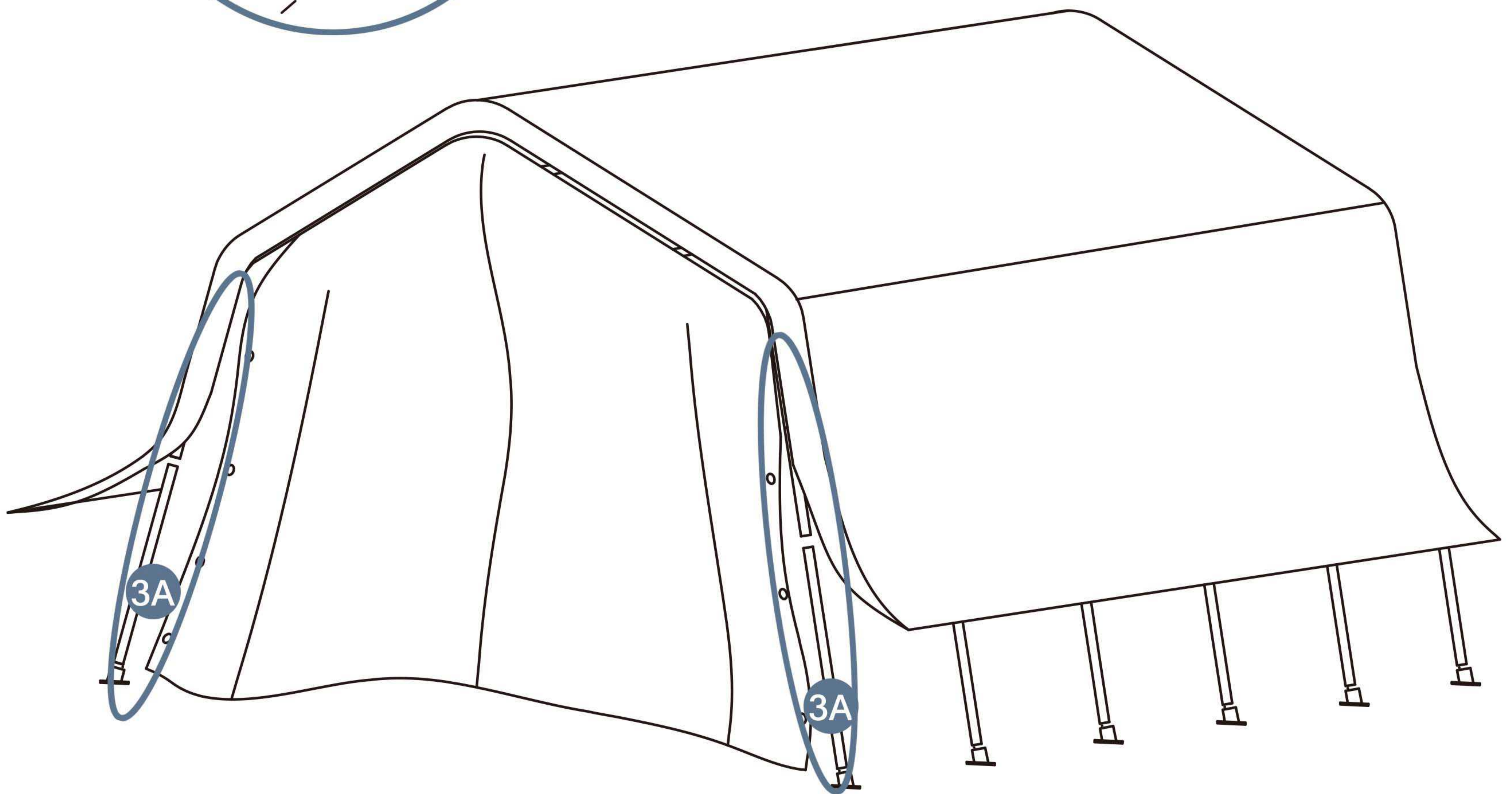
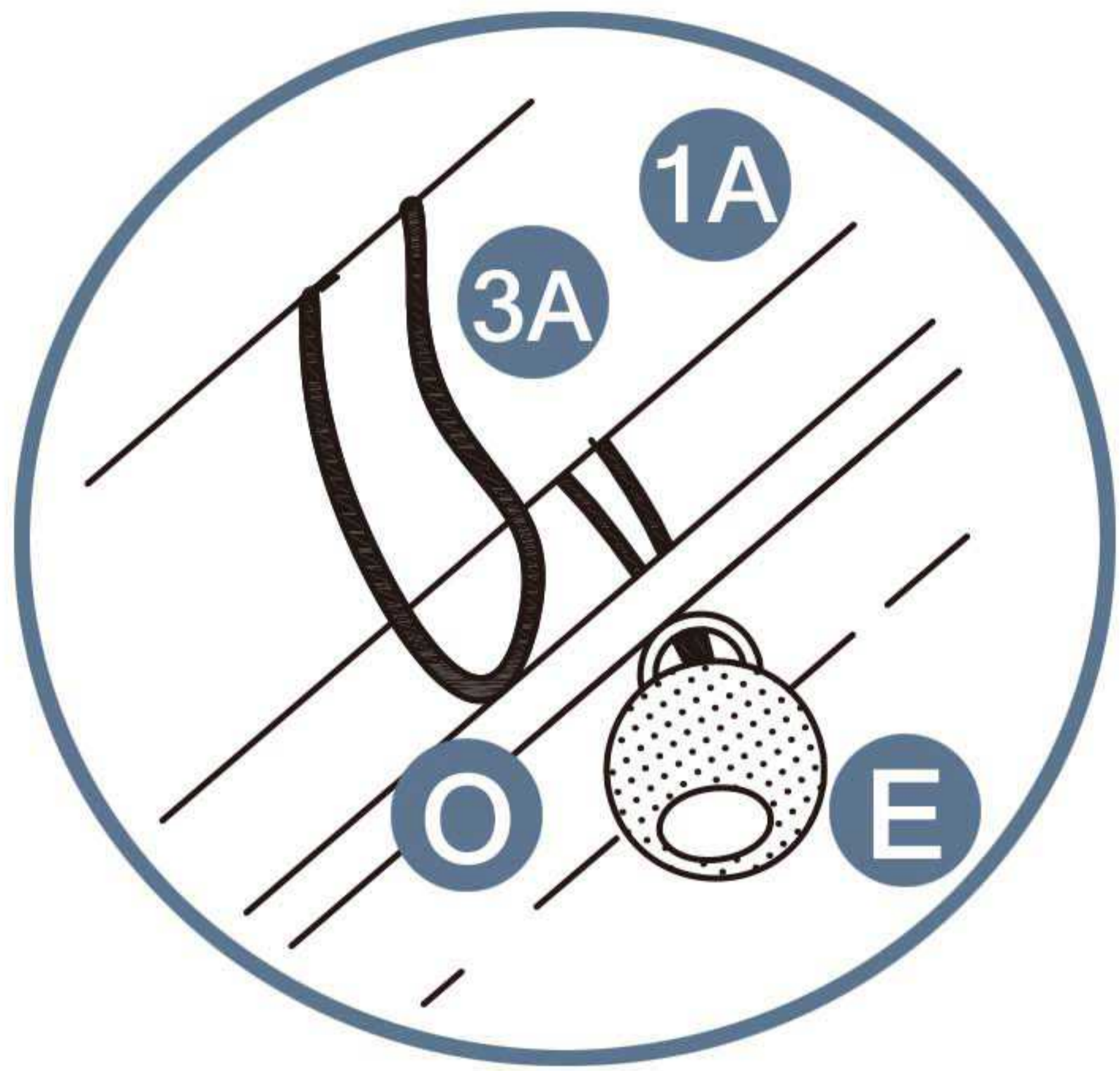





Please take care of the screws and contact the after-sales service if there is any problem with the installation or parts.

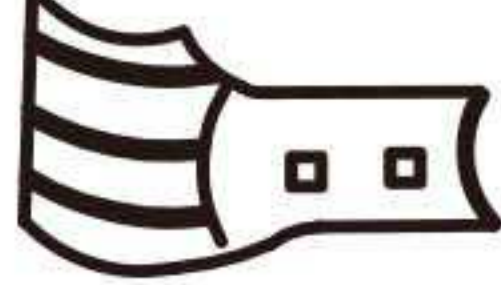

E-mail: cs.helper01@gmail.com

STEP 9

Parts required

-  **J** 8pcs
 -  **K** 16pcs
 -  **4** 10pcs
 -  **H** 40pcs
- M6x45

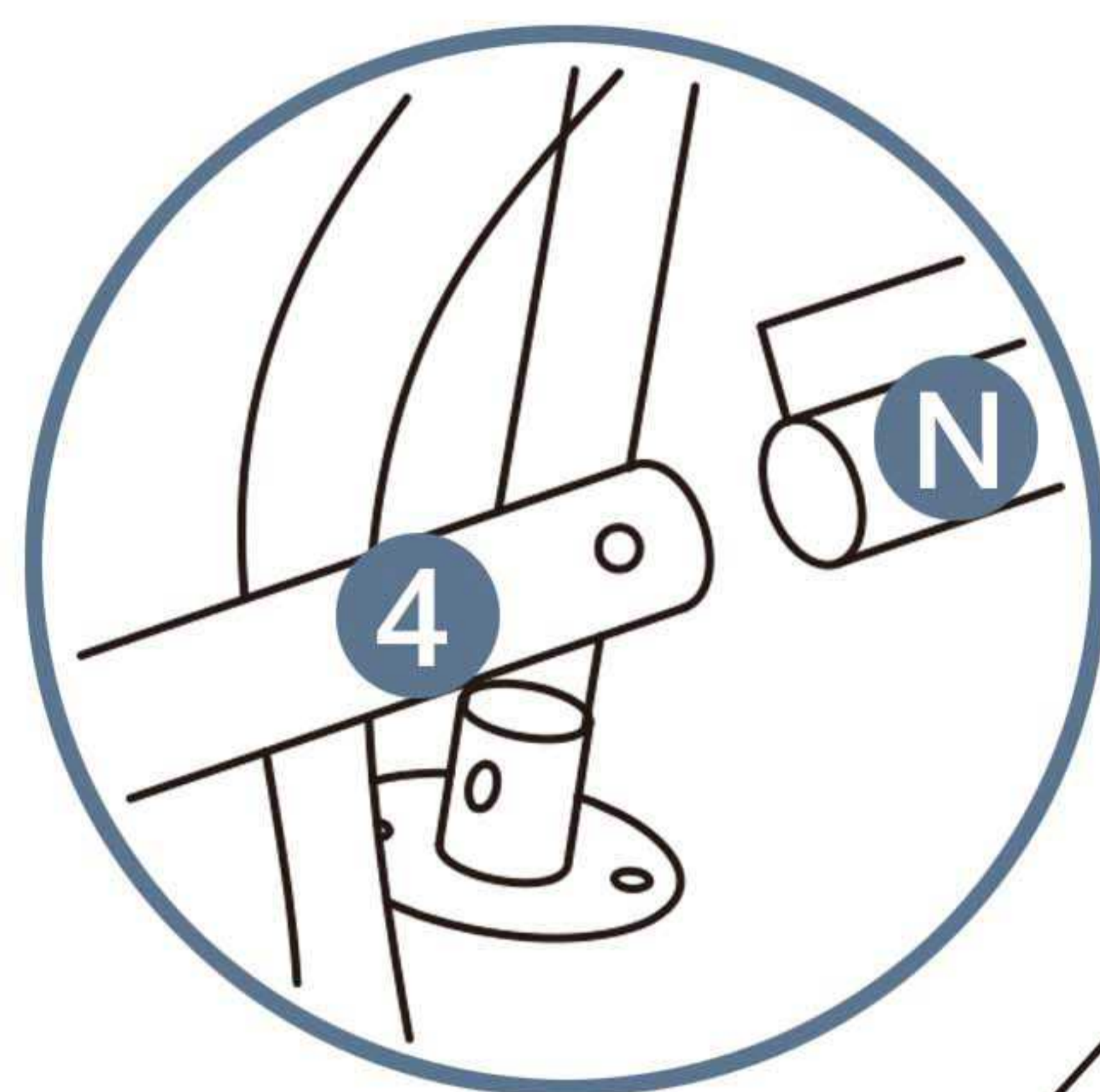

1

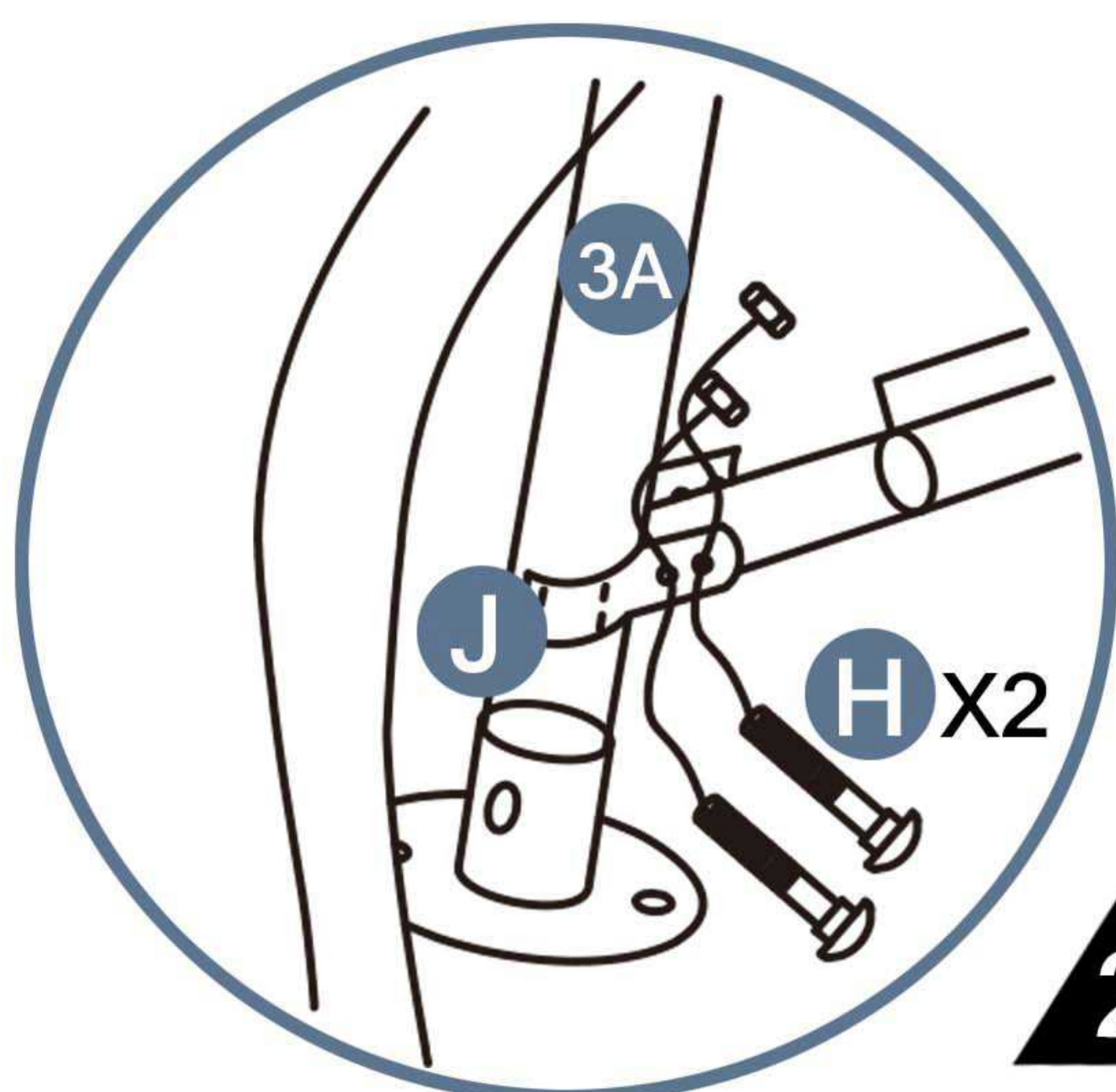
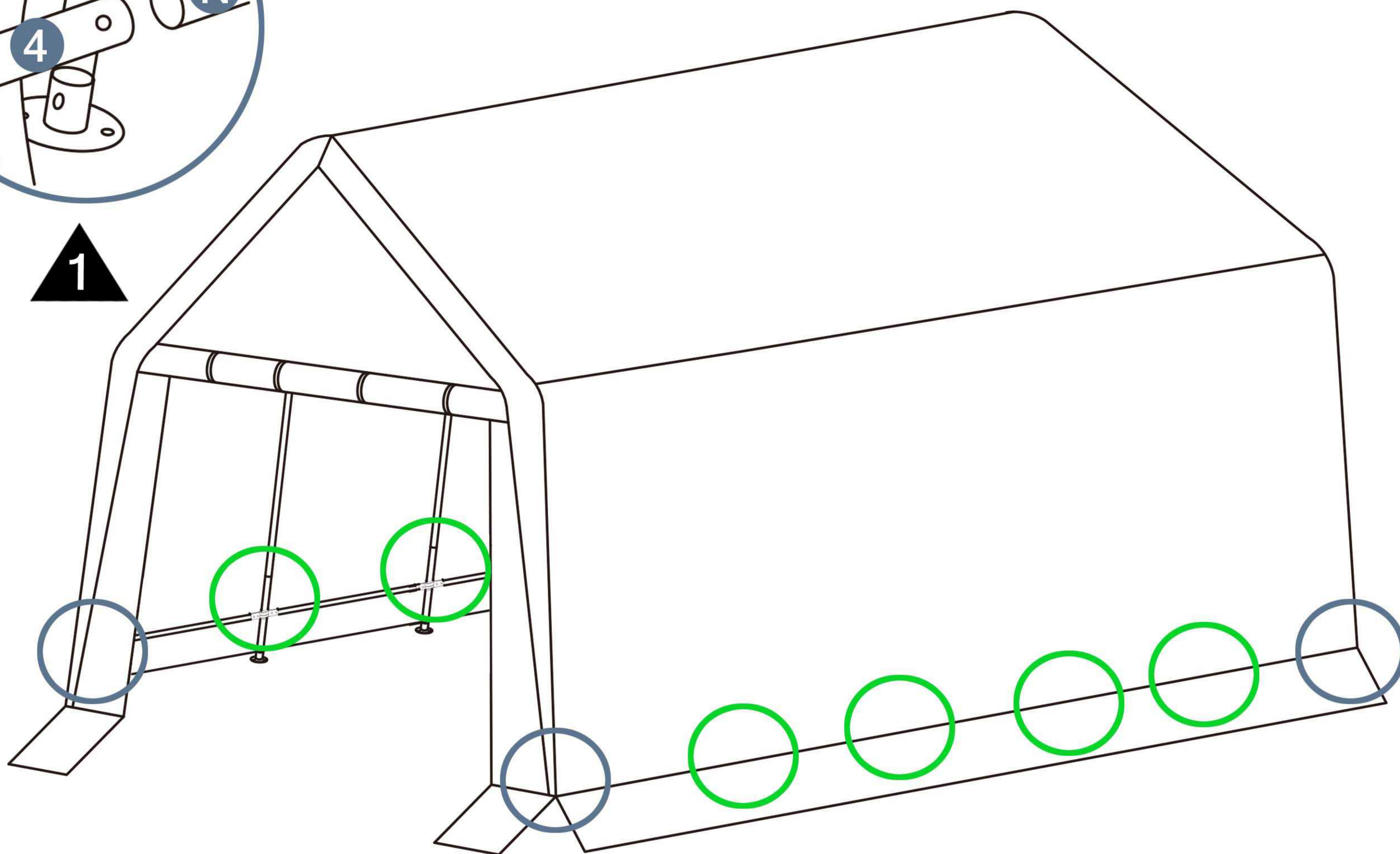

2

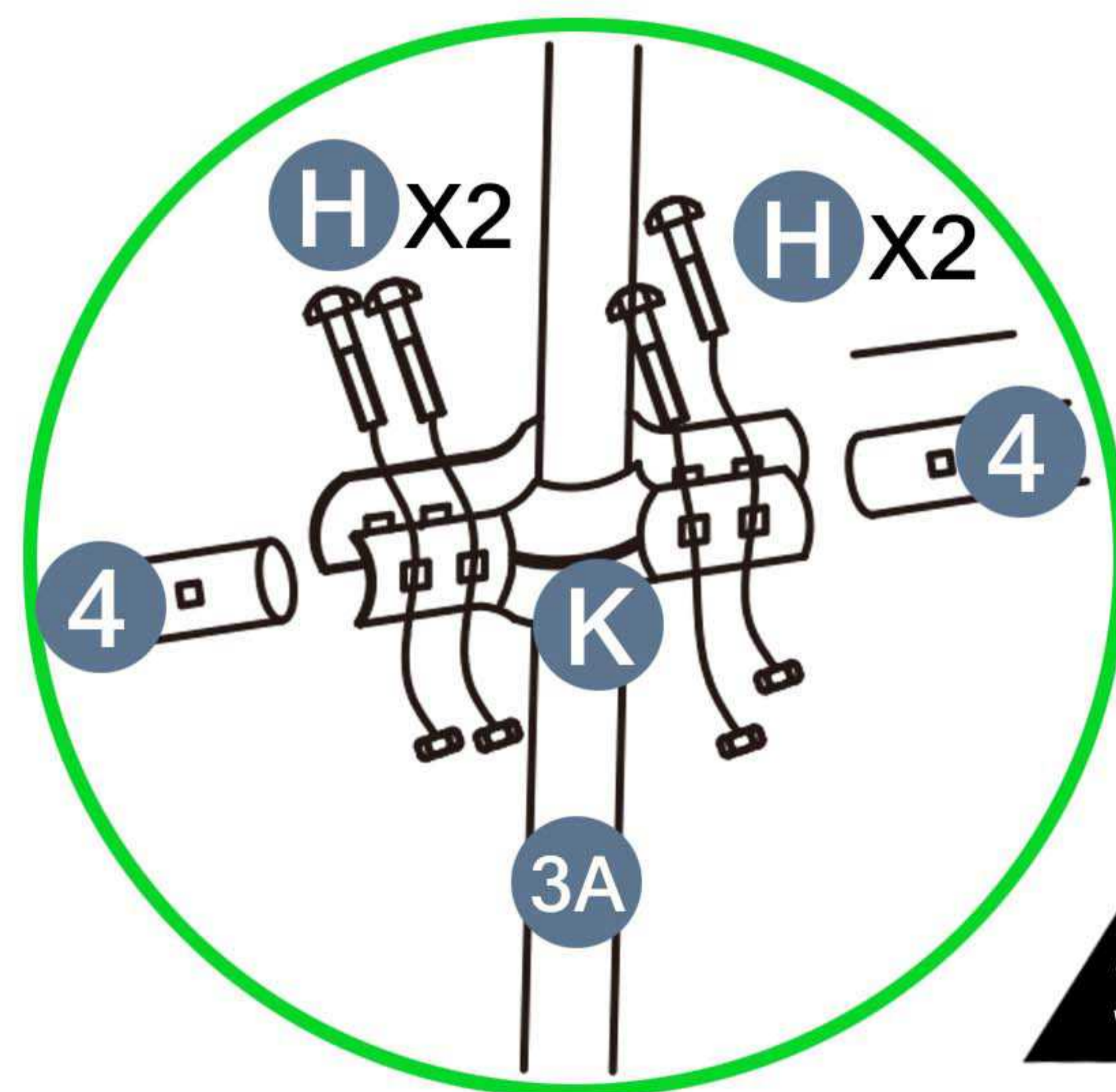

3

Please take care of the screws and contact the after-sales service if there is any problem with the installation or parts.

➔ ✉ E-mail: cs.helper01@gmail.com

STEP 10

Parts required

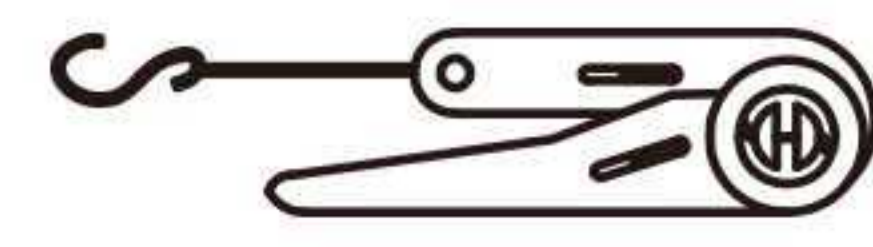

L 4pcs

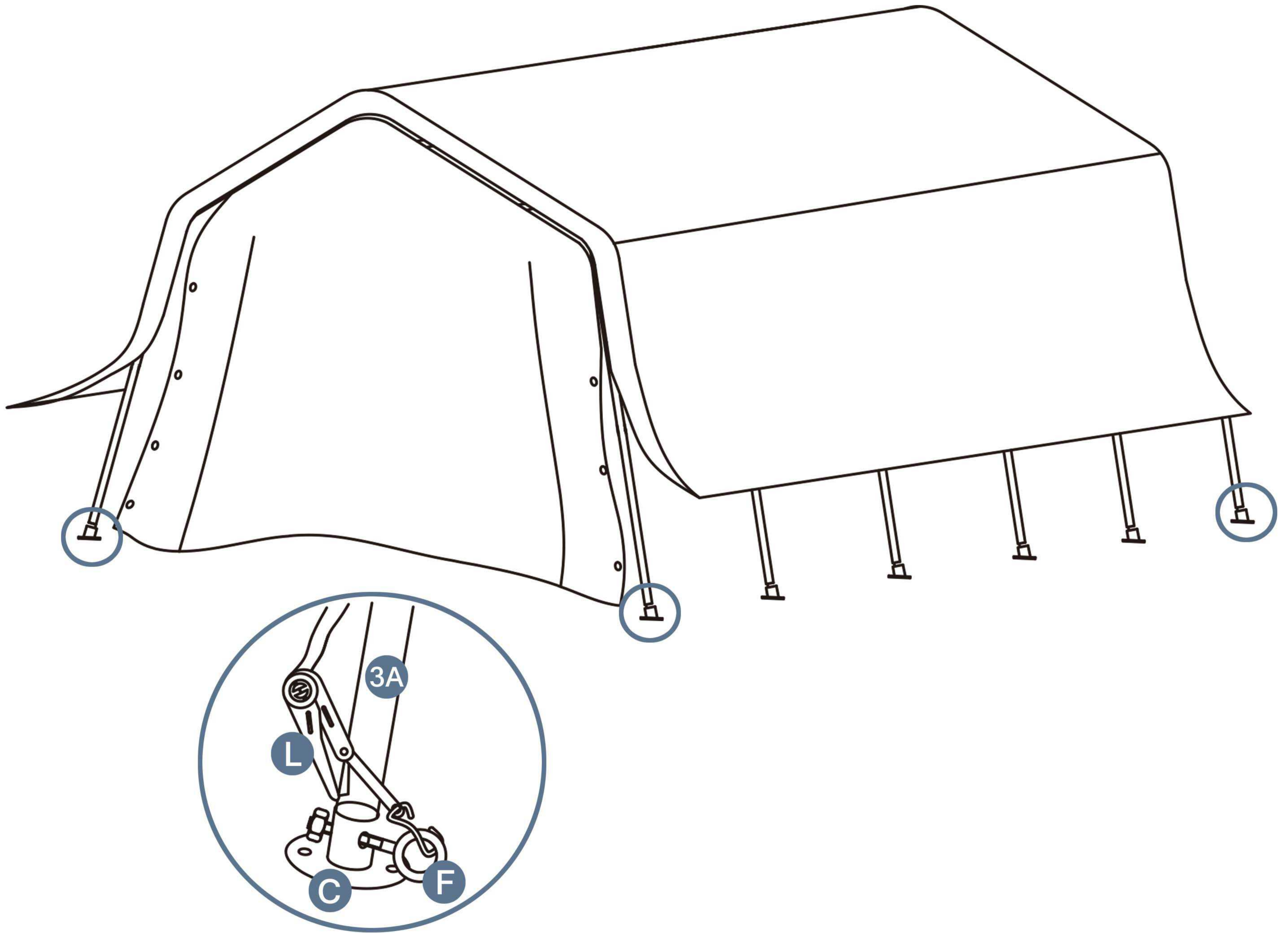

→ If you can't install it, please browse pages 17 and 18, or contact us.

Please take care of the screws and contact the after-sales service if there is any problem with the installation or parts.

STEP 11

Parts required

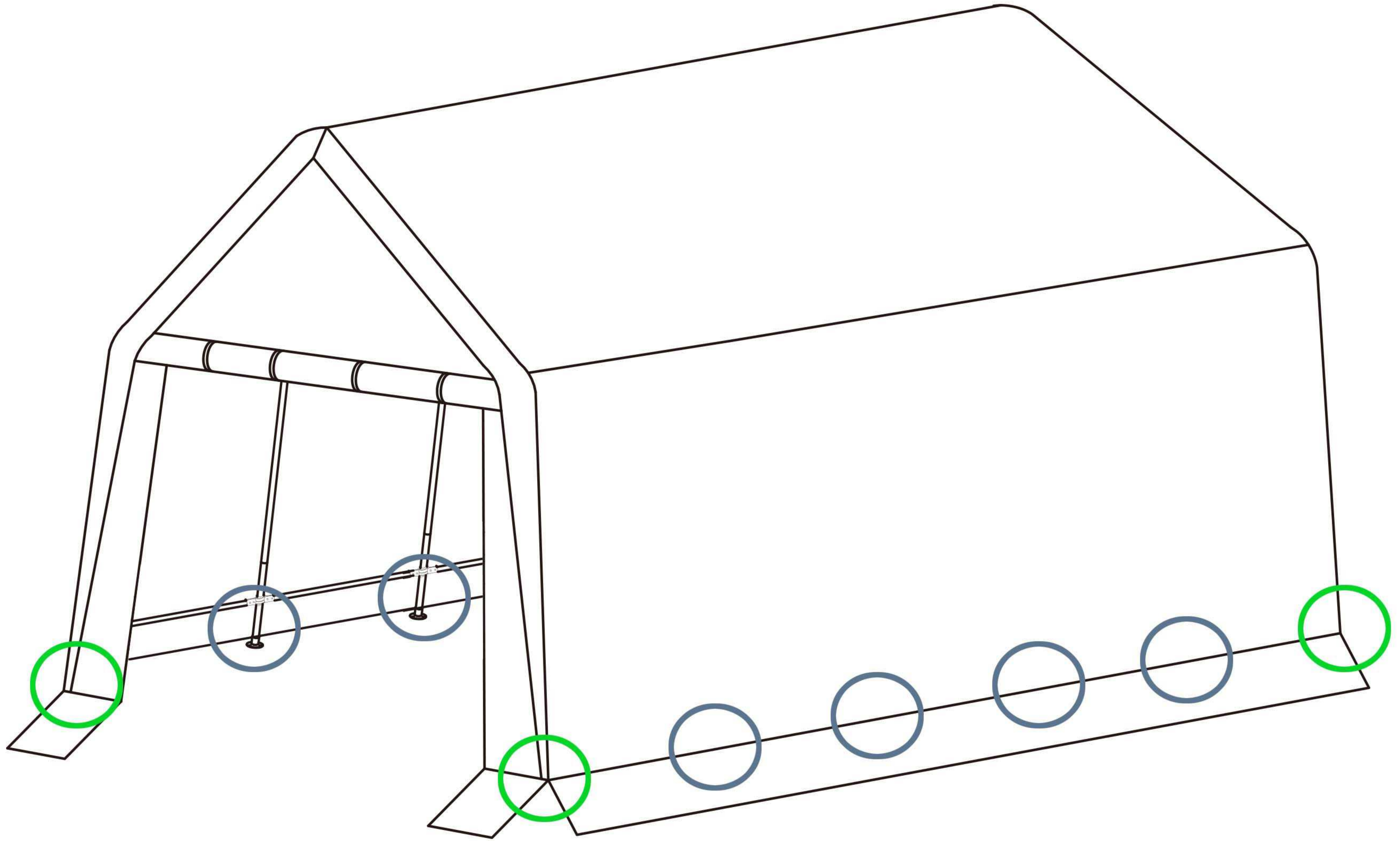
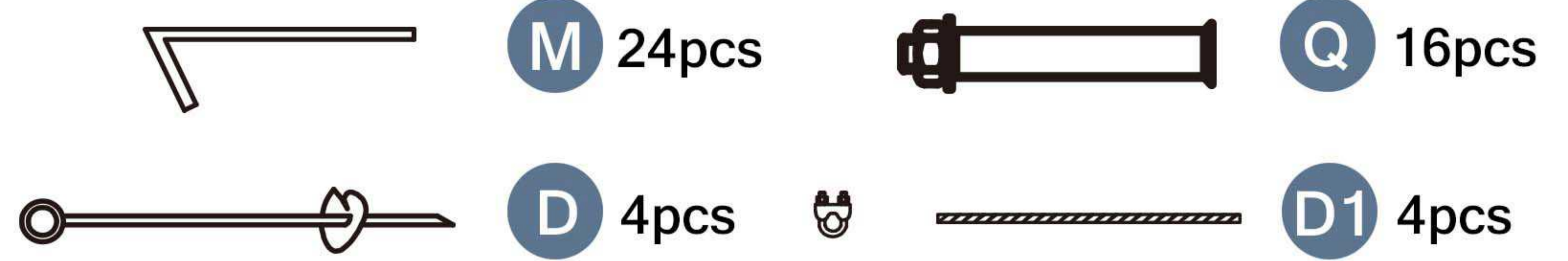

You Can Choose To Use

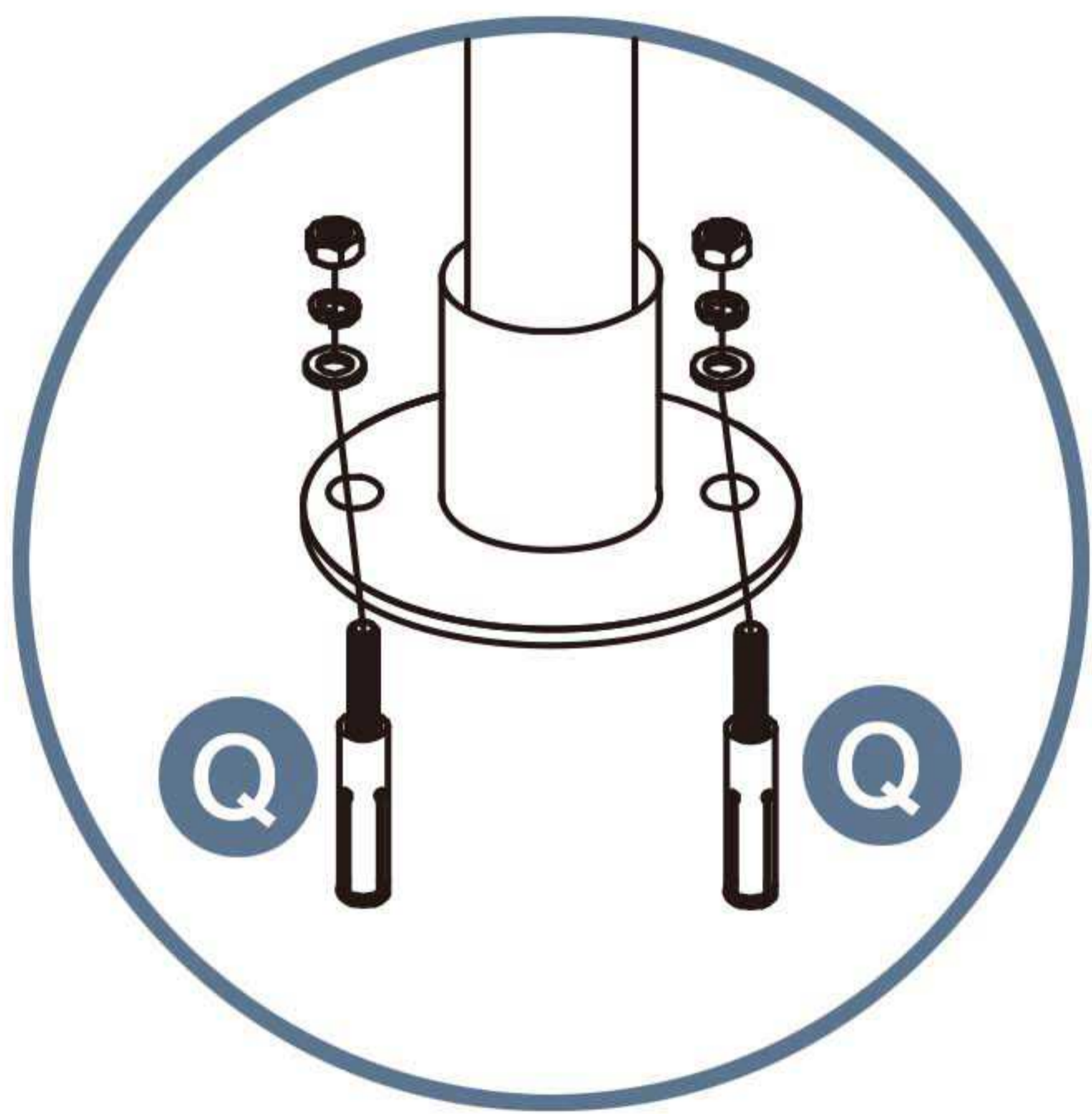

Used for mixed mud land

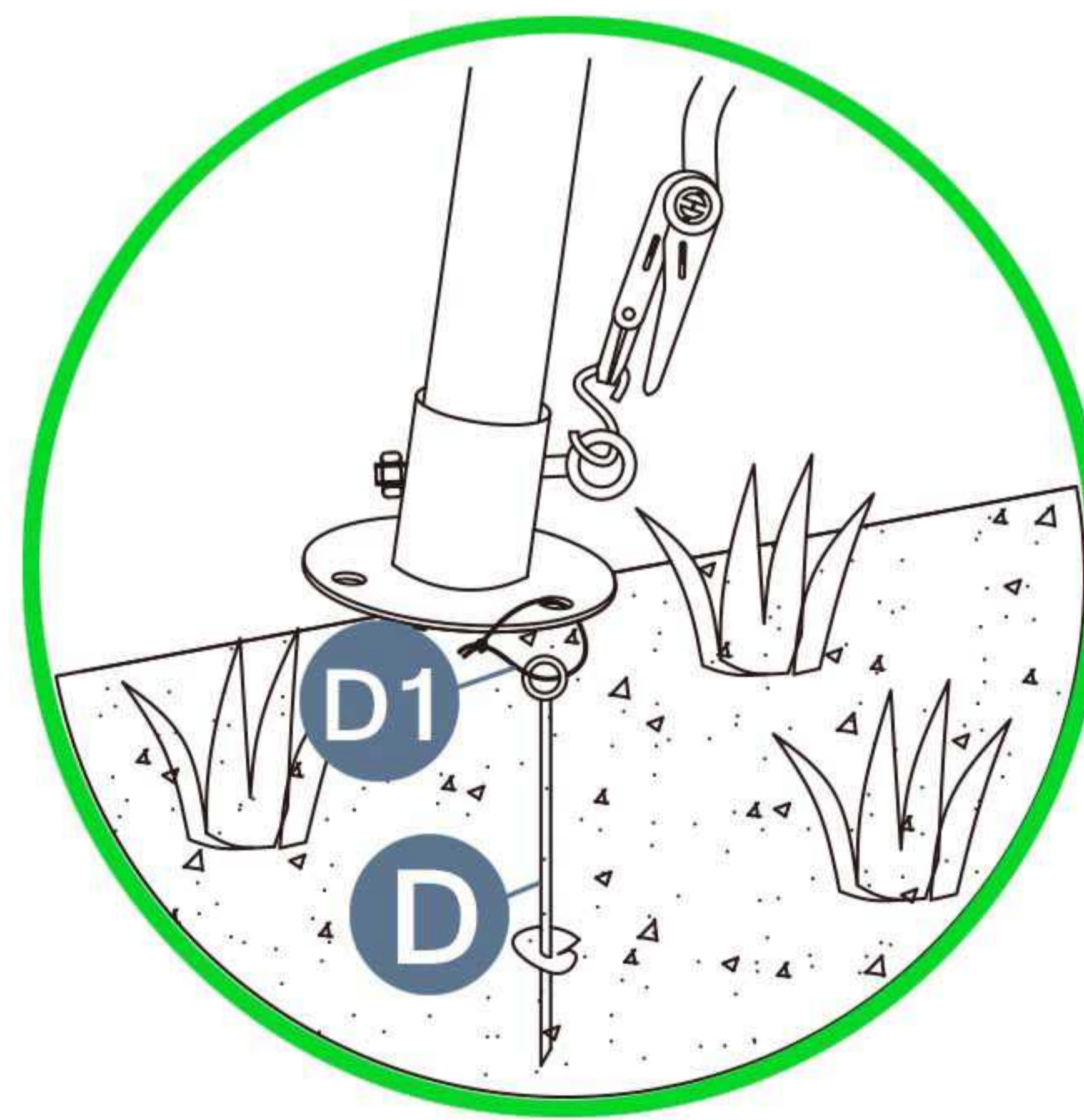

These two are installed at the same time for lawns and muddy land.

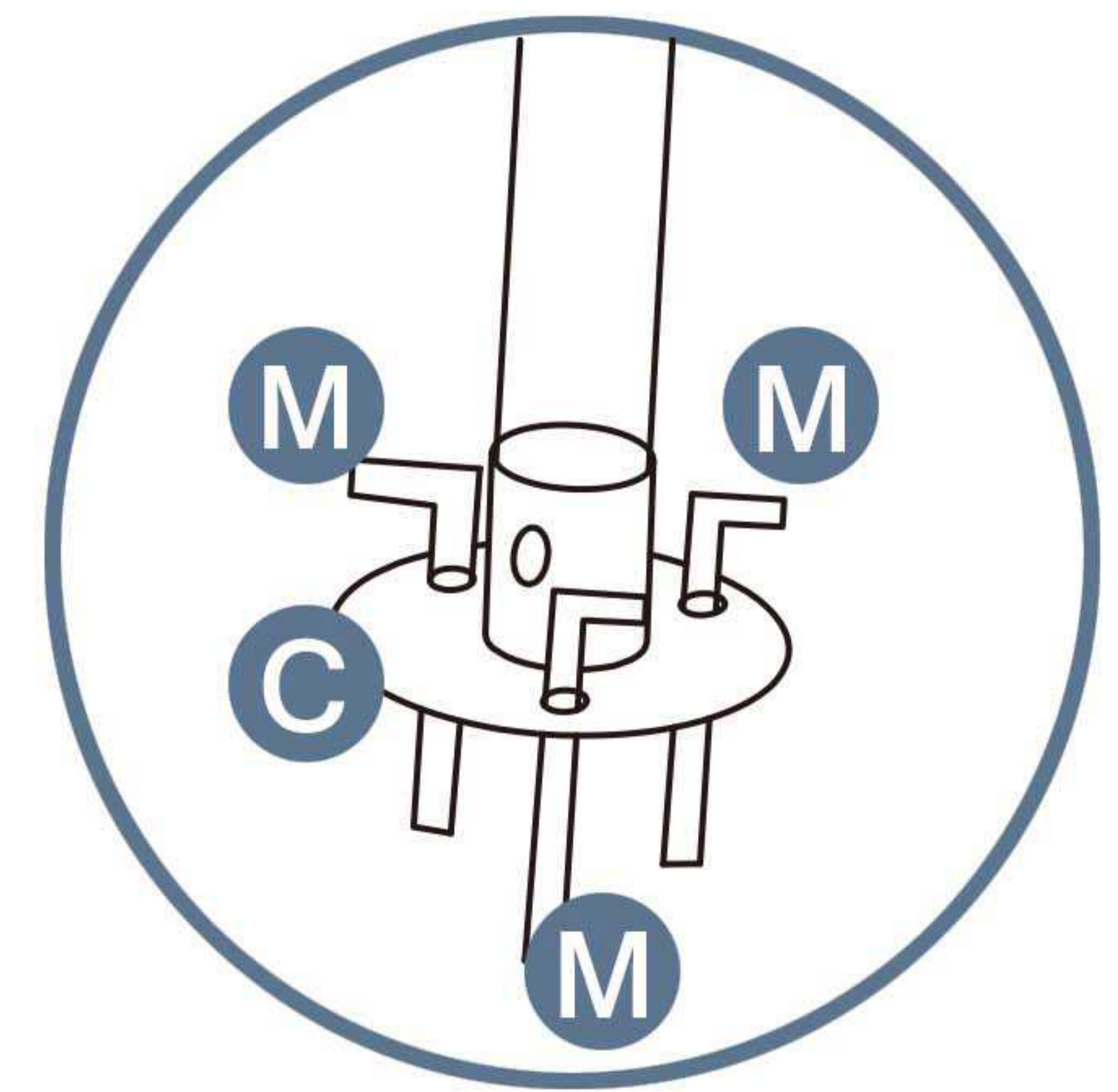

Please take care of the screws and contact the after-sales service if there is any problem with the installation or parts.

➔ ✉ E-mail: cs.helper01@gmail.com

Securing Ratchet Tie-Downs

1. Thread the strap through the Ratchet's "L" spindle as far as it will go.

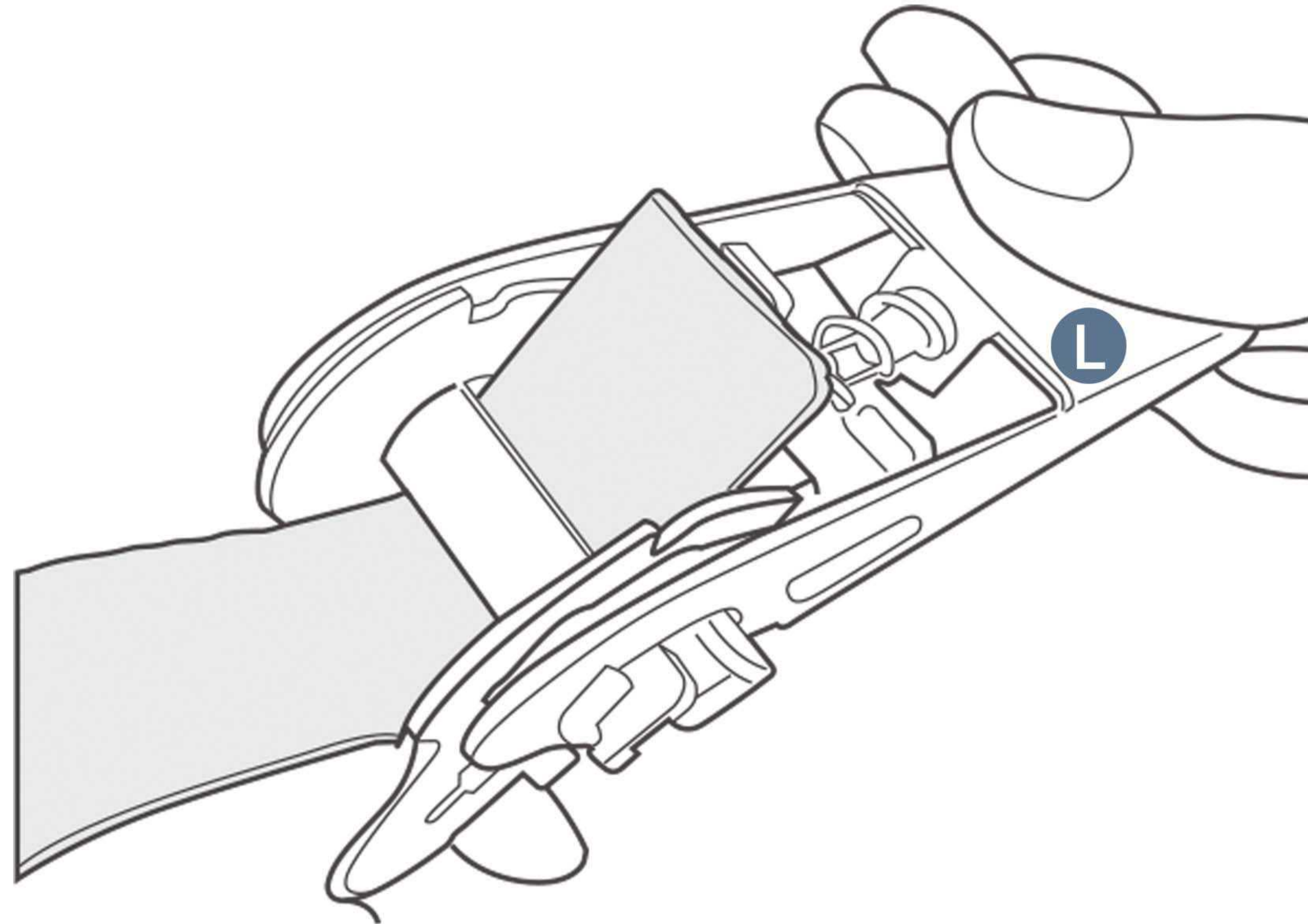

2. Insert the S-hook of the Ratchet into the hole in the Corner Leg "F" .

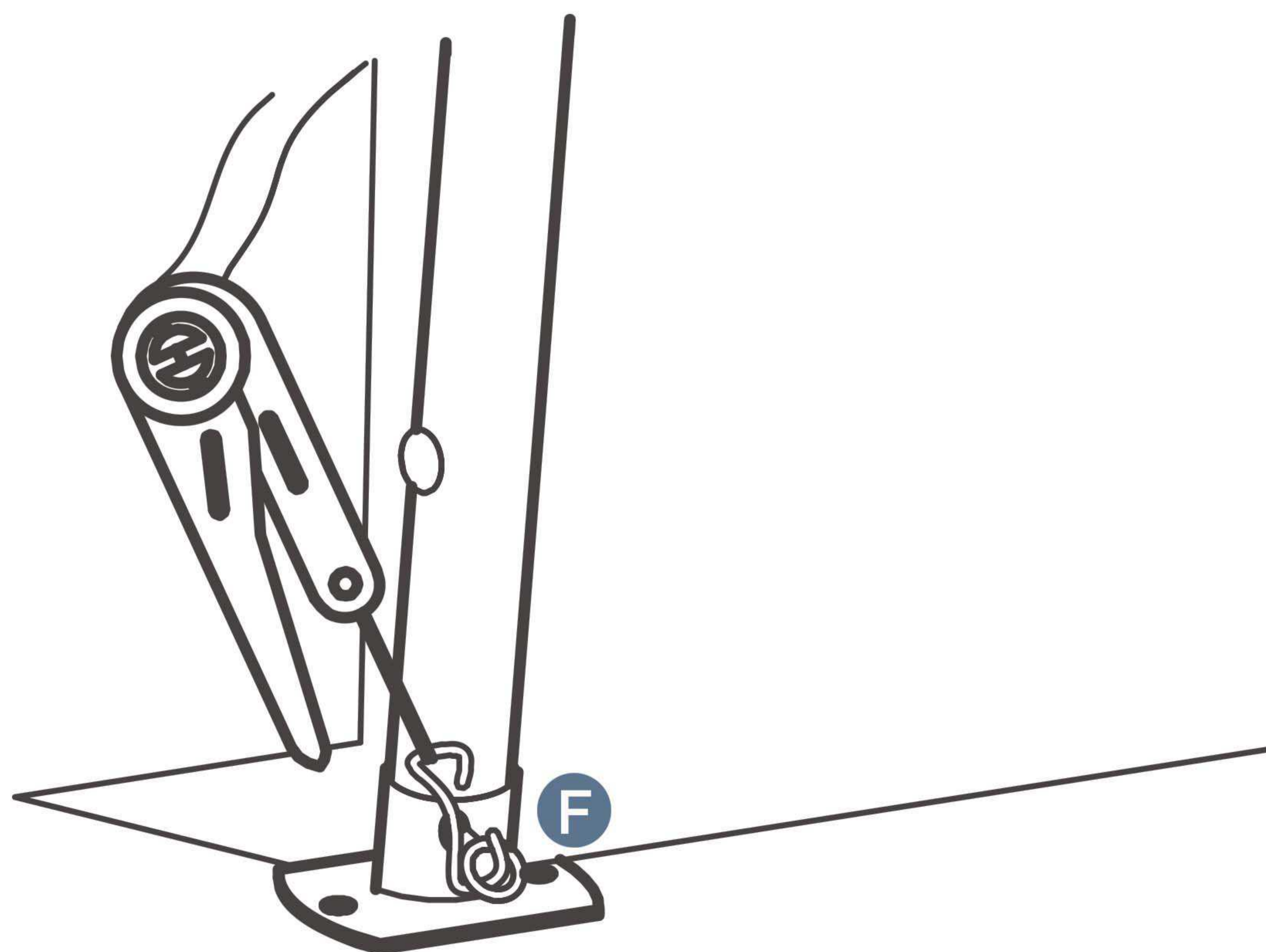

Please take care of the screws and contact the after-sales service if there is any problem with the installation or parts.

→ ✉ E-mail: cs.helper01@gmail.com

3. Lift and lower the Ratchet's handle to wind and tighten the strap onto the spindle. Excessive tightening will damage straps, Covers and Corner Legs.

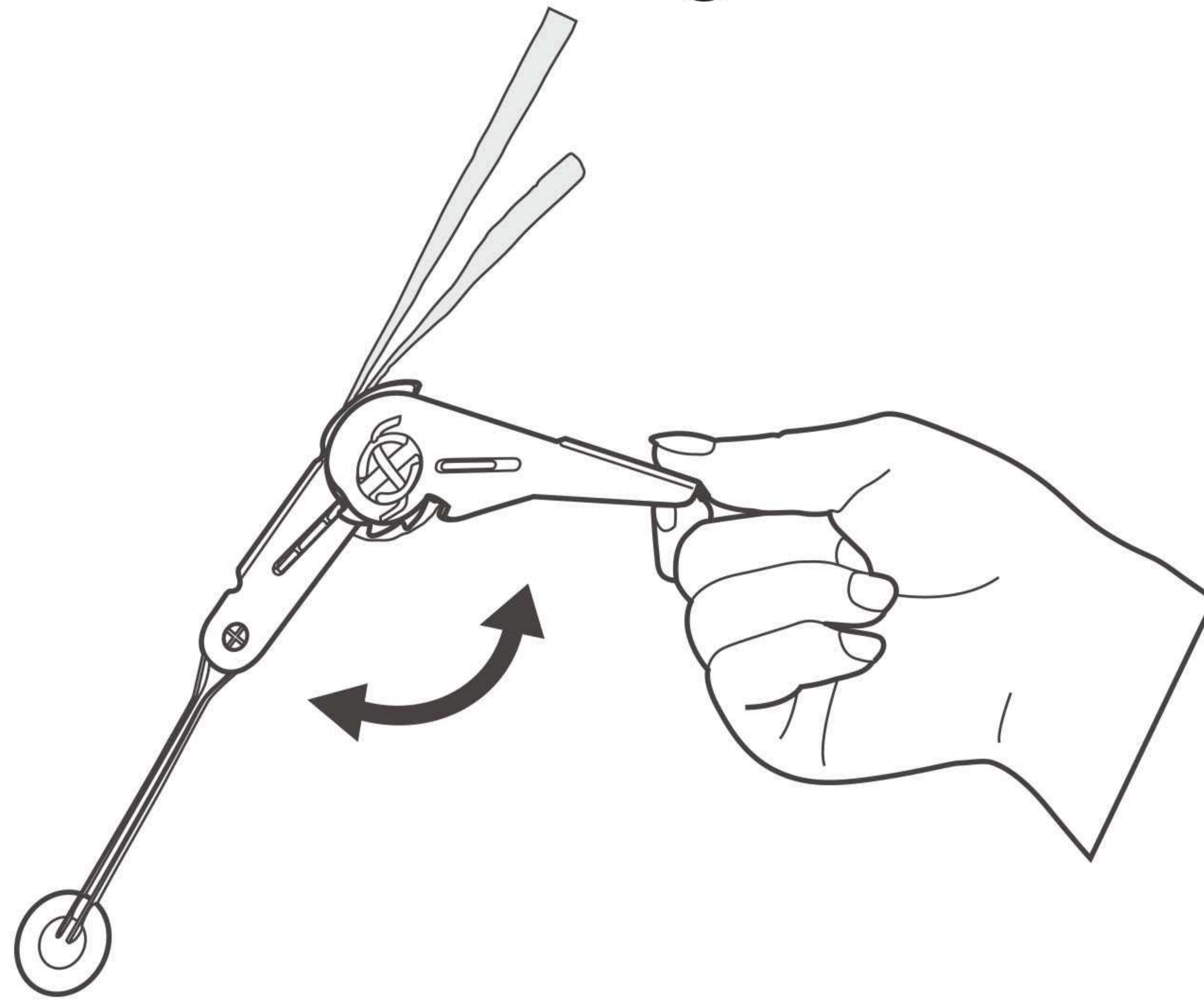

Releasing Ratchet Tie-Downs

1. Depress the spring-loaded bar on the handle.
2. Open Ratchet handle completely.
3. Unwind the strap.

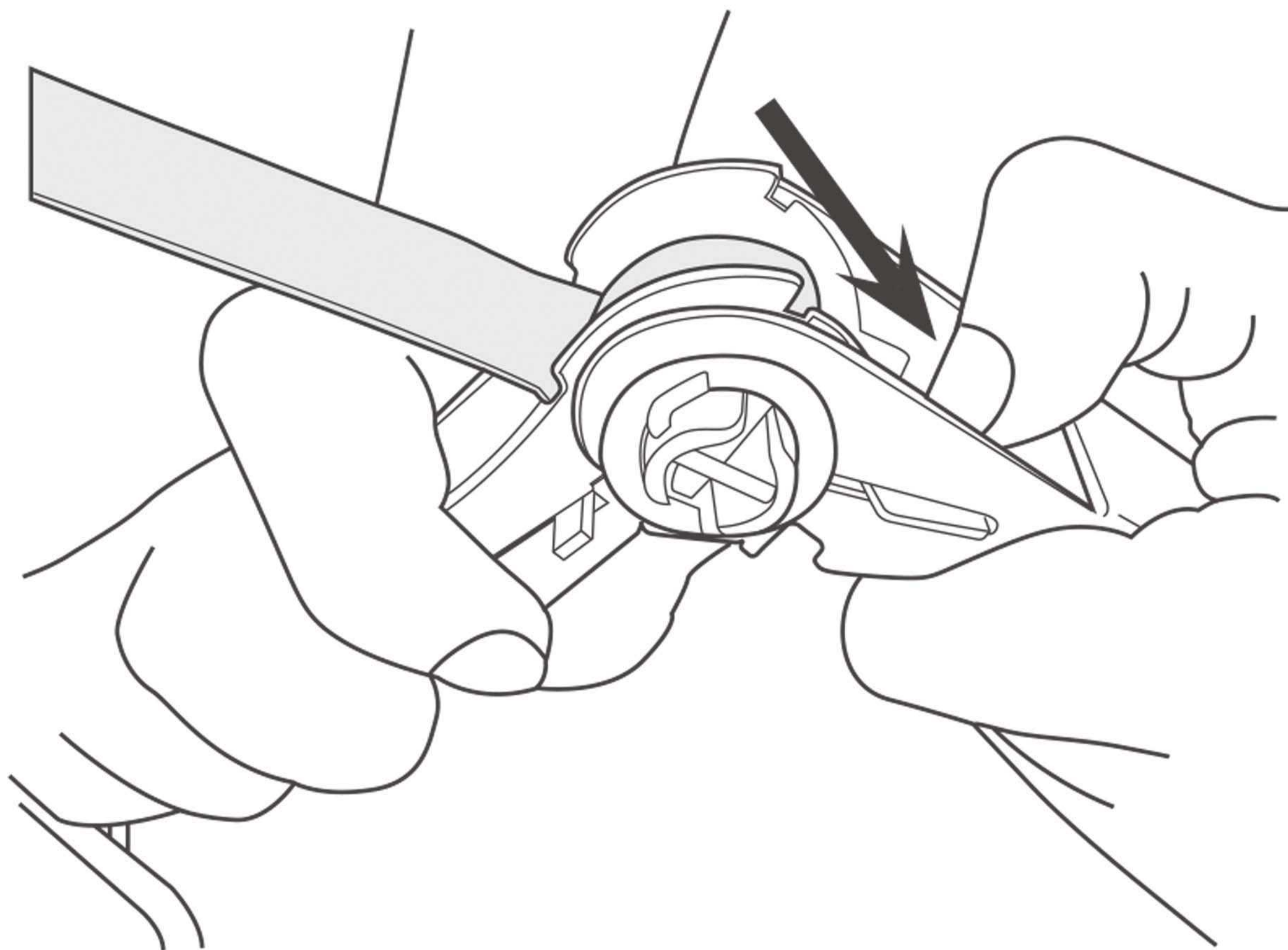

Hope you enjoy this product.

If you have any concerns about gazebo Installation, please feel free to contact us. We will reply within 24 hours.



E-mail: cs.helper01@gmail.com