



RANGE HOOD Manual

EMPV-30RH05

EMPAVA APPLIANCES INC.
Add: 458 Parriott Pl W
City of Industry, CA, 91745
TEL : 888-682-8882
WWW.EMPAVA.COM

Dear consumer,

Thanks for your purchase of our range hood and we hope we can fully satisfy all of your needs. Please read the entire instructions carefully before proceeding to obtain the best results of operation the range hood.

TECHNICAL CHARACTERISTICS

Total power: 204W

Motor power: 200W

Led Light: 2x2W

Voltage: 120V

Frequency: 60Hz

Filter: Steel Baffle filter

Control: 3 Speed Touch Control

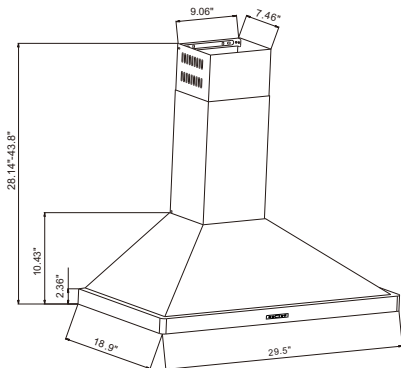

Please note that this product is marked with symbol: 
According to Waste of Electrical Electron Equipment (WEEE) directive, WEEE should be separately collected and treated. If at any time in future you need to dispose of this product, please do NOT dispose of this product with household waste. Please send this product to WEEE collecting points where available.

MAIN PARTS NAME

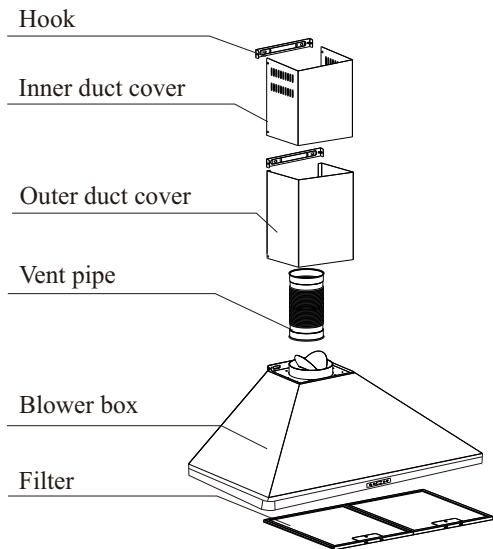

INSTALLATION REQUIREMENT

1. Do not install the range hood where there are many doors or windows in order to avoid effecting the exhaust efficiency of the hood that caused by air convection. (fig.1)
2. Install the range hood right above the cooking surface. The recommended distance between the cooking surface and the lower edge of the range hood is minimum 24" to maximum 33". (Fig.2)
3. In order to get the best performance, do not extend the vent pipe too long, and try to make the bend of the vent pipe less and straight, make sure the vent pipe connection is firm and air proof. (Fig.3)
4. After hanging the range hood on the wall, make sure the hood is level and vertical. (Fig.4)
5. The air Outlet is not allowed to connect to chimney flues or combustion gas ducts. The air outlet should under no circumstances be connected to ventilation ducts for room in which fuel-burning appliances are installed.

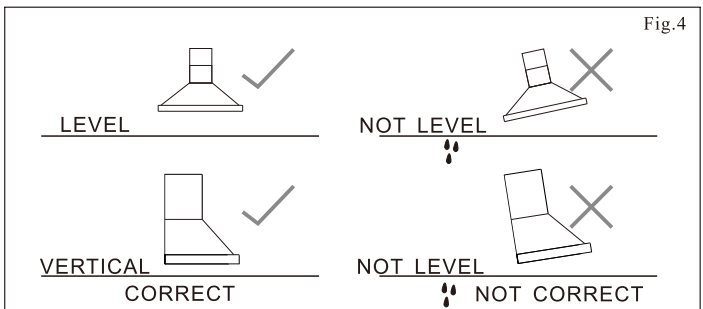
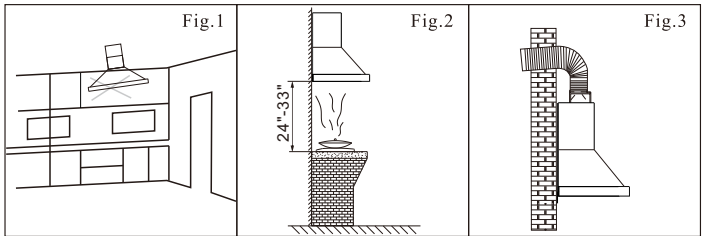

INSTALLATION PROCEDURES

SAFETY WARNING

HOOD MAY HAVE VERY SHARP EDGES; PLEASE WEAR PROTECTIVE GLOVES IF IT IS NECESSARY TO REMOVE ANY PARTS FOR INSTALLING, CLEANING OR SERVICING.

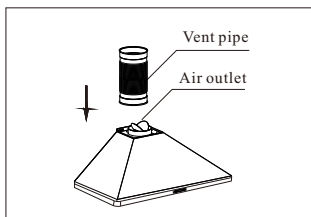

Step 1:
Put the vent pipe to the air outlet like this picture. And use one ST3.9x10 screw to fix the vent pipe.

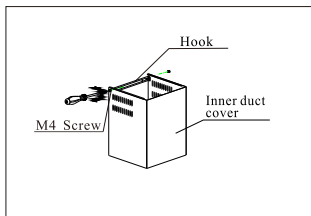

Step 2:
Matching the hook to the holes of the inner duct cover and fix it well with M4 screws.

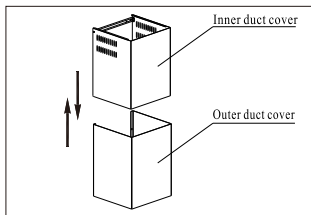

Step 3:
Insert the inner duct cover into the outer duct cover.

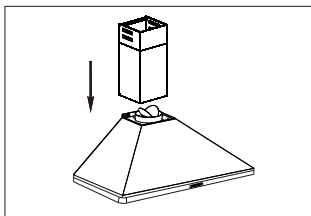

Step 4:
Matching the holes of the outer duct cover and blower box, fix the outer duct cover to the blower box using 8pcs M4*10 screw provided with the fixing tool as the direction of the illustrated.

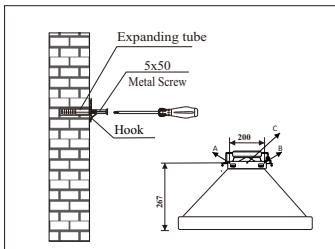

Step5:

According to the size of hook key holes. Drill 3 holes in level in the wall with 10mm in diameter and 2.95"-3.35" in depth. Press the 3 expanding tube provided into the holes. Fix the hook using the 5x50 metal screw provided. Then insert three M5X50 screws to A and B And C holes to fix the hook on the wall steadily.

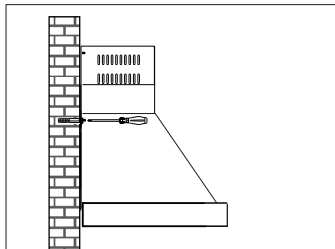

Step 6:

Hang the entire hood onto the hook, ensure the hood is level and vertical.

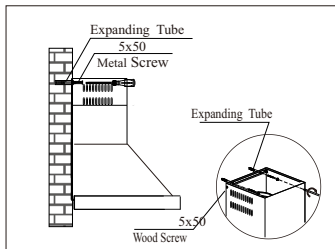

Step 7:

1. Draw the inner duct cover up to the suitable height, mark on the wall two keyhole of the outer duct cover bracket with pen .
2. Put down the inner duct cover gently, drill the keyholes in 2.95"-3.35" depth on the horizontal level using 10mm drill.
3. Press the expanding tube provided into the holes.
4. Matching the inner duct cover with the holes, tighten the inner duct cover with two 5x50 metal screw provided.

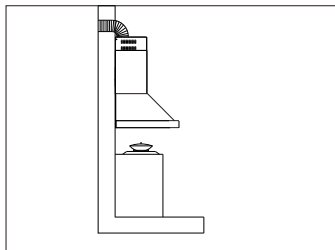

Step 8:

Extend the air outlet of the exhaust pipe out-of-door. Try to make the bend of the exhaust pipe is no more than 120°.

OPERATING INSTRUCTION

Touch control

- A. Time
- B. Speed
- C. Light
- D. On/Off



A. **Timer setting:** Delay turn off.

- 1). In motor working mode, press D once to enter into 1 minute delay turn off mode, press again to turn off immediately.
- 2). In motor working mode, press A to enter into 3 minutes delay turn off mode, press again for 4-59 minutes, maximum 59 minutes. Then wait 3 seconds or press B to confirm.

Clock setting:

- A. In Off mode, press A approximately 3 seconds to set time. Press B to set hours from 1-11 or 1-23; Press C to set minutes from 1-59. After get right time on the screen, wait 3 seconds or press A to confirm.
- B. In standby mode, press to start Speed 1, press again for speed 2 and 3, recycle.
- C. Light: Press to turn on or turn off the light.
- D. On/Off: In standby mode, press to activate speed and time buttons. In motor working mode, press to turn off the hood.

24H or 12H setting

The default time system is 12 hours. After power on press LIGHT button C 3 seconds to set 24 Hour or 12 Hour. It will show 12H or 24H on the screen and flashing 5 seconds for confirmation, then reset time.

MAINTENANCE

CAUTION: NEVER PUT YOUR HAND INTO THE AREA HOUSING WHILE THE FAN IS OPERATING.

FOR THE OPTIMAL LEVEL OF OPERATION, CLEAN THE RANGE HOOD SURFACE, AN AND ALUMINUM FILTER REGULARLY.

1. Use only mild soap or detergent solutions to clean the range hood surface. Dry surfaces using soft cloth.
2. Using a stainless steel cleaner to bring the glow back into a stainless finish.
3. Clean the filter once a week or according to use status. Press the buckle of the filter slightly, take off the filter and put it into warm soapy water using mild detergent, wipe the filter with soft brush. Replace the filter after it's dry.
4. Clean the motor fan and other inside parts once half year or according to use status by **QUALIFIED PERSON**.
5. **DO NOT** clean motor with water or other liquid.

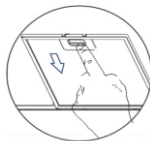

TO REPLACE LIGHT

To replace Led light (Pic.1)

Caution: LED light can not replace a new bulb, just replace a new LED light assembly.

Make sure all the control switches are off, and the range hood is unplugged! Please follow below instructions:

1. Take out the filters, and cut off the wire connection of the light.
2. Press the spring according to the arrow direction, then you can take off the LED light.
3. You can replace a new LED assembly no more than rating.
4. Then put the light assembly to the hood in reverse direction. Connect the wire of the lamp.
5. Fit on the filters.

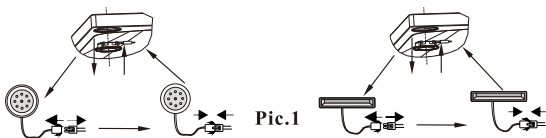

IMPORTANT SAFETY INSTRUCTIONS:



Do not connect the air outlet to chimney flues or combustion gas ducts

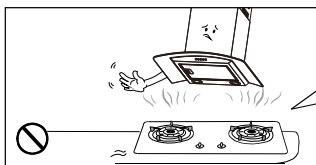

Do not leave naked flames under the hood



In case of any damage to power cable, replace the broken cable with a new one by qualified person.



Do clean the hood correctly in accordance with instruction stated or it might cause the possibility of fire accident

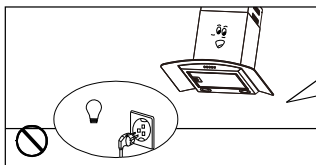

To replace the LED light should be undertaken by a qualified electrician or a competent person. Always use the light no more than rating.

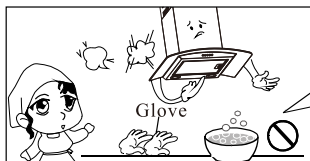

Dress the protective glove before you start to clean the hood. Remove the components gently during carrying out the clearance.

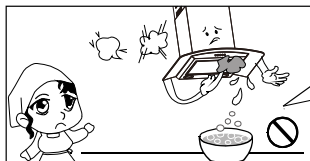

Never wash the control switch with water or other kind of liquid to avoid the liquid might cause electrical problem to the hood.

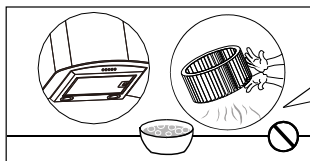

To clean the motor fan should be undertaken by a qualified person, pay top attention to avoid any distortion of the fan during carrying out the clearance.

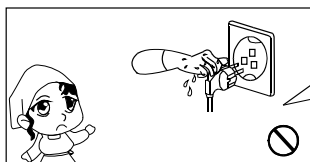

Never pull the plug out of the power supply by wet hand to avoid the possibility of electric shock.

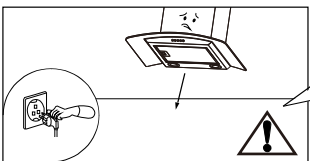

Disconnect the range hood from the power supply if this appliance will not be used for a long time.

WARNING – TO REDUCE THE RISK OF A RANGE TOP GREASE FIRE:

- a) Never leave surface units unattended at high settings. Boilovers cause smoking and greasy spillovers that may ignite. Heat oils slowly on low or medium settings.
- b) Always turn hood ON when cooking at high heat or when flambeing food (i.e. Crepes Suzette, Cherries Jubilee, Peppercorn Beef Flambe’).
- c) Clean ventilating fans frequently. Grease should not be allowed to accumulate on fan or filter.
- d) Use proper pan size. Always use cookware appropriate for the size of the surface element.

WARNING – TO REDUCE THE RISK OF INJURY TO PERSONS IN THE EVENT OF A RANGE TOP GREASE FIRE, OBSERVE THE FOLLOWING: SMOTHER FLAMES with a close-fitting lid, cookie sheet, or metal tray, then turn off the burner. **BE CAREFUL TO PREVENT BURNS.**

If the flames do not go out immediately, **EVACUATE AND CALL THE FIRE DEPARTMENT.**

- b) **NEVER PICK UP A FLAMING PAN** – You may be burned.
- c) **DO NOT USE WATER**, including wet dishcloths or towels – a violent steam explosion will result.
- d) Use an extinguisher **ONLY** if:
 - 1) You know you have a Class ABC extinguisher, and you already know how to operate it.
 - 2) The fire is small and contained in the area where it started.
 - 3) The fire department is being called.
 - 4) You can fight the fire with your back to an exit.

WARNING: TO PROVIDE PROTECTION AGAINST ELECTRIC SHOCK, CONNECT TO PROPERLY GROUNDED OUTLETS ONLY.

A UTILISER SEULEMENT AVEC UNE TROUSSE DE RACCORDEMENT DE CORDON DE HOTTE VÉRIFIÉE ET APPROUVÉE POUR EMPLOI AVEC CE MODÈLE DE HOTTE.

WARNING - To Reduce The Risk Of Fire Or Electric Shock, Do Not Use This Fan With Any Solid-State Speed Control Device. AVERTISSEMENT : NE CONVIENT PAS A DES REGULATEURS DE VITESSE A SEMI-CONDUCTEURS.

GROUNDING INSTRUCTIONS

This appliance must be grounded. In the event of an electrical short circuit, grounding reduces the risk of electric shock by providing an escape wire for the electric current. This appliance is equipped with a cord having a grounding wire with a grounding plug. The plug must be plugged into an outlet that is properly installed and grounded.

WARNING – Improper grounding can result in a risk of electric shock.

Consult a qualified electrician if the grounding instructions are not completely understood, or if doubt exists as to whether the appliance is properly grounded.

Do not use an extension cord. If the power supply cord is too short, have a qualified electrician install an outlet near the appliance

CONSIGNES DE MISE A LA TERRE

Cet appareil doit être mis à la terre. En cas de court-circuit, le fil de mise à la terre limite le risqué de choc électrique parce qu’il assure le retour du courant à la terre. L’appareil est livré avec un cordon muni d’un fil de terre et d’une fiche de mise à la terre, qui doit être branchée sur une prise mise à la terre correctement installée.

AVERTISSEMENT — Une mise à la terre incorrecte peut entraîner des risques de choc électrique. Consulter un électricien compétent en cas de doute sur ces consignes de mise à la terre ou en cas d’incertitude concernant la mise à la terre correcte du circuit sur lequel l’appareil est branché.

Ne pas utiliser de cordon de rallonge. Si le cordon d’alimentation est trop court, faire installer une prise par un électricien compétent à proximité de l’appareil.

WARNING - TO REDUCE THE RISK OF FIRE, USE ONLY METAL DUCT WORK.

TROUBLE SHOOTING

CAUTION: Disconnect the power supply before servicing.

Status	Cause and Method of Repairing	Tools required
No power	Check circuit breakers If the power supply is damaged, please call for a qualified person	Philips Screwdriver
The motor does not run	a).The motor is broken, replace motor. b). The switch control is broken, replace switch. c). The capacitor is broken, replace capacitor.	Philips Screwdriver
Body vibration	a).The installation is not correct, check it and make sure the hood is level. b). The fan is broken, replace motor assembly. c). The fan motor was not properly installed, check and make sure it is firmly installed.	Philips Screwdriver
Noise vibration	Something dropped into the blower, check and clean blower.	Philips Screwdriver
Weak suction	a). The distance from the range hood to cooking surface is too far, make sure the distance between bottom of the hood to cooking surface is minimum 24" to maximum 27". b). Windows, doors and drafts can effect the performance of the range hood. c). There are other air conditions effecting the vent pipe, make sure lower vent pipe's exit is in a downward direction. d). The running rate of the motor slows down, replace the motor or capacitor. If the range hood is near the window, the best solution is to protect the back of the range hood from draft caused by a window or door.	Philips Screwdriver
Light does not work	Replace LED lamp.	Philips Screwdriver



WARNING!
CALIFORNIA RESIDENTS
Cancer and Reproductive Harm



AVERTISSEMENT!
RÉSIDENTS DE CALIFORNIE
Cancer et Dommages à la Reproduction



¡ADVERTENCIA!
RESIDENTES DE CALIFORNIA
Cáncer y Daño Reproductivo

www.P65Warnings.ca.gov

EMPAVA APPLIANCES INC

**Address:458 Parriott Place West, City of Industry,
California 91745,United States**

TEL : 888-682-8882

WWW.EMPAVA.COM