

Assembly Instructions

CAUTION



• Inspect the wire insulation for any cuts, abrasions, or exposed copper that may have resulted during shipping. If there is a defect in the wire, do not attempt installation.

• Before starting installation of this fixture or removal of a previous fixture, disconnect the power by turning off the circuit breaker or by removing the fuse at the fuse box.

TOOLS REQUIRED



Ladder



Safety glasses



Electrical tape



Phillips screwdriver



Flat blade screwdriver



Pliers

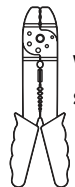

Wire strippers

HARDWARE INCLUDED



Fixture

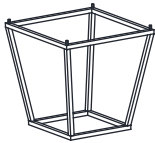

Iron Rack



Ball Nuts



Chain



Canopy



Screw Collar Ring



Mounting Unit



Mounting Screws



Wire Nuts

*PARTS SHOWN MAY DIFFER SLIGHTLY PER LIGHT FIXTURE

EXPLODED PARTS

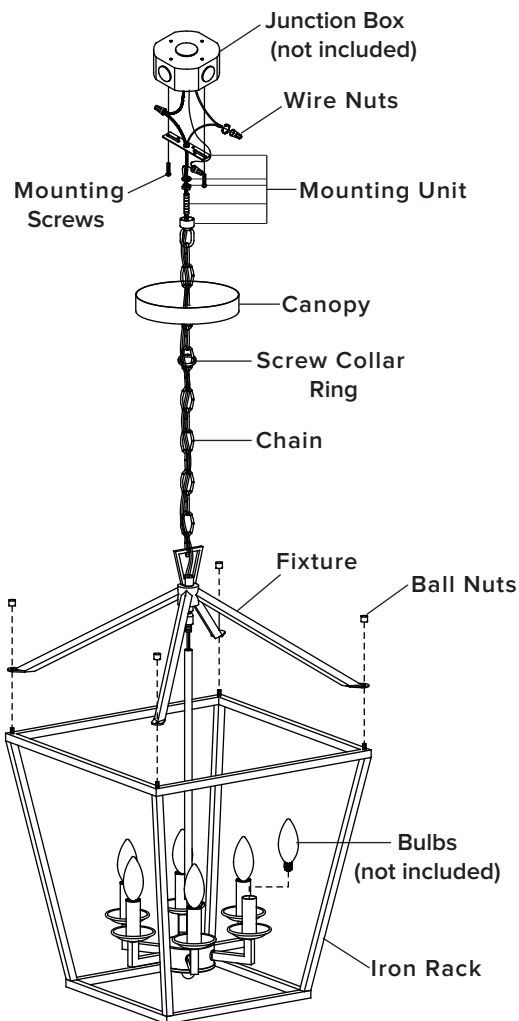

INSTALLATION

STEP 1

Attach the **iron rack** onto **fixture** using **ball nuts**.

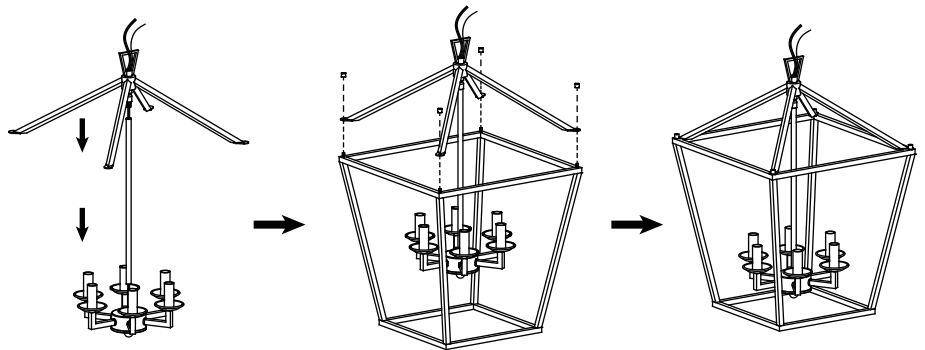

STEP 2

Attach the end of the **chain** to the loop on the **fixture**.

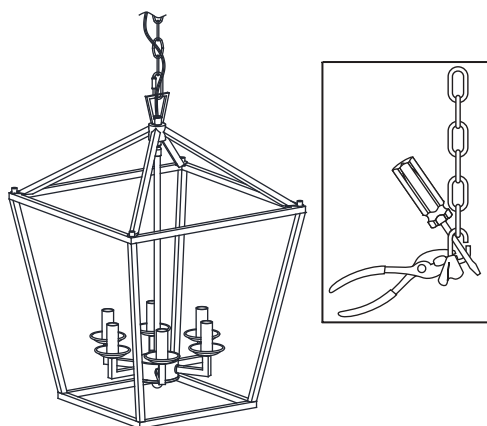

STEP 3

Use the **mounting screws** to attach the **mounting unit** to the junction box (not included).

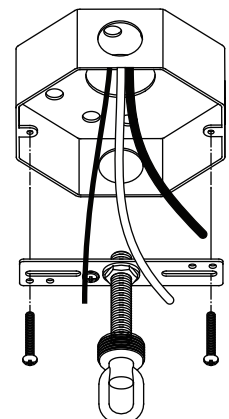

Assembly Instructions

INSTALLATION

STEP 4

Pass the **chain** and the branchwires through the **screw collar ring** and **canopy**. Feed the branchwires through the pipe nipple on the **mounting unit** and attach the end of the **chain** to the **mounting unit**.

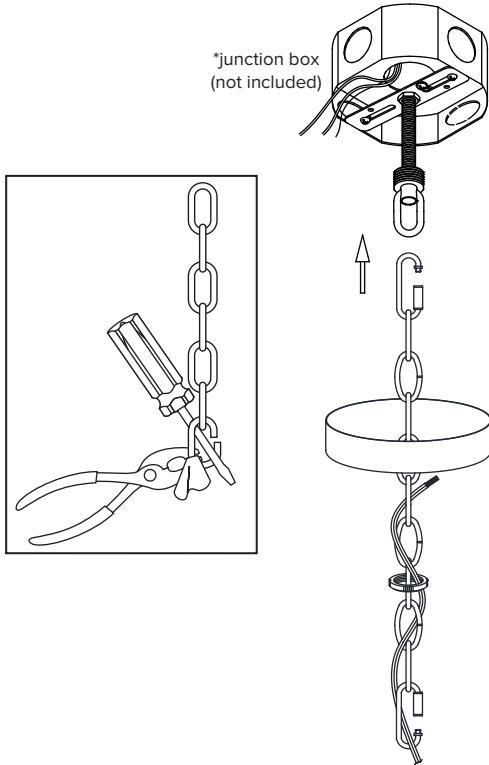

STEP 5

Make the electrical connection from the junction box (not included) to the **fixture**. Connect the ground wire to the **mounting unit** using the preinstalled green ground screw. Then, connect the positive, negative and ground wires with the supplied **wire nuts**. Secure with electrical tape

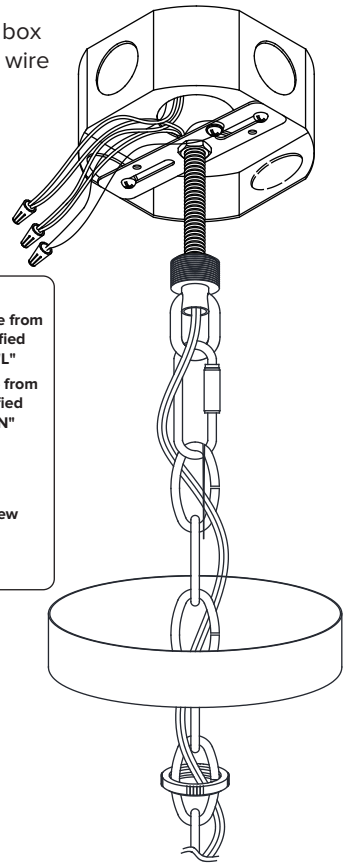
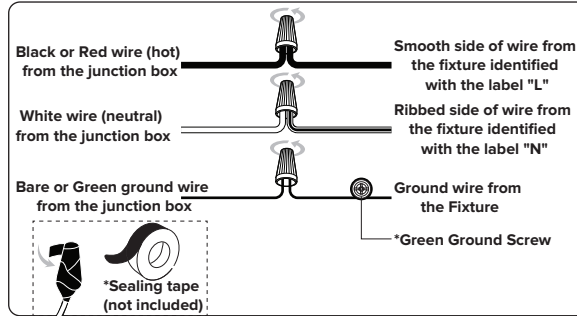

STEP 6

Secure the **canopy** to the **mounting unit** with the **screw collar ring**.

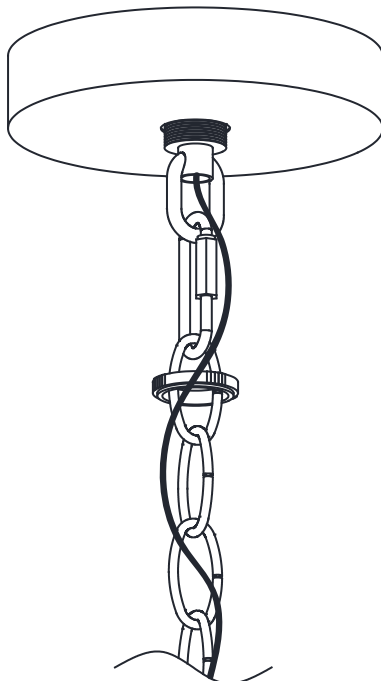

STEP 7

Install bulbs (not included)

