

DAEWOO 
ELECTRONICS

REFRIGERATOR

FR-033RVBE
(compact refrigerator for MF-9B033B)

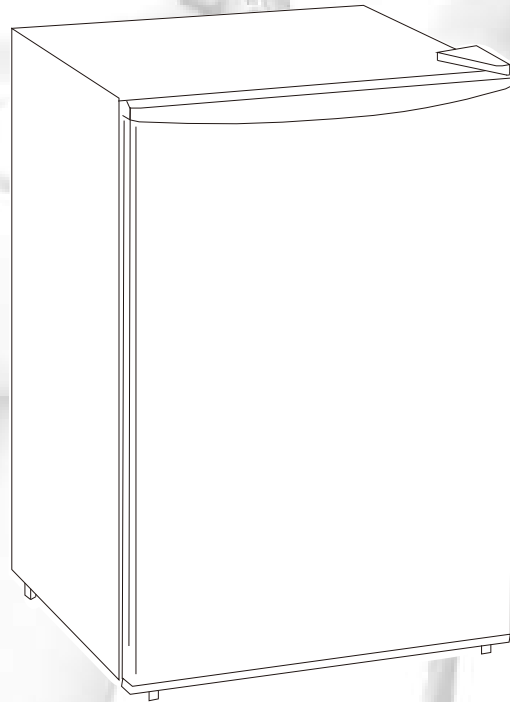

Contents

| | |
|--------------------------------------------------------------|---|
| 1. SAFETY WARNINGS..... | 1 |
| 2. INSTALLATION..... | 1 |
| 2.1 Location..... | 2 |
| 2.2 Reversing the Door Swing | 2 |
| 2.3 Door Space Requirements..... | 3 |
| 2.4 Levelling the Unit..... | 4 |
| 2.5 Cleaning Before Use..... | 4 |
| 2.6 Before Using Your Unit..... | 4 |
| 2.7 Interior Accessories | 4 |
| 3. PRODUCT OVERVIEW..... | 4 |
| 4. OPERATION..... | 5 |
| 4.1 Switching On Your Unit..... | 5 |
| 4.2 Noise Inside the Unit | 5 |
| 4.3 Tips for Keeping Food in the Unit..... | 6 |
| 5. CLEANING..... | 6 |
| 5.1 Defrosting..... | 6 |
| 5.2 Cleaning the Interior and the Exterior of the Unit | 6 |
| 5.3 Cleaning Tips..... | 6 |
| 6. MAINTENANCE..... | 7 |
| 6.1 Care When Handling / Moving Your Unit..... | 7 |
| 6.2 Servicing | 7 |
| 6.3 Switching Of for Long Periods of Time..... | 7 |
| 7. TROUBLE SHOOTING | 7 |
| 7.1 Warm tips:..... | 8 |

1.SAFETY WARNINGS

- 1) **WARNING**— Do not use mechanical devices or other means to accelerate the defrosting process, other than those recommended by the manufacturer.
- 2) **WARNING**— Do not damage the refrigerant circuit.
- 3) **WARNING**— Do not use electrical appliances inside the food storage compartments of the appliance, unless they are of the type recommended by the manufacturer.
- 4) **WARNING**— **DANGER:** Risk of child entrapment. Before you throw away your old refrigerator or freezer;
 - Take off the doors
 - Leave the shelves in place so that children may not easily climb inside.
- 5) The appliance has to be unplugged after use and before carrying out user maintenance on the appliance.
- 6) This appliance can be used by children aged from 8 years and above and persons with reduce physical sensory or mental capabilities or lack of experience and knowledge if they have been given supervision or instruction concerning use of the appliance in a safe way and understand the hazards involved. Children shall not play with the appliance. Cleaning and user maintenance shall not be made by children without supervision.
- 7) If the supply cord is damaged, it must be replaced by the manufacturer, its service agent or similarly qualified persons in order to avoid a hazard.
- 8) Please abandon the refrigerator according to local regulators for it use flammable blowing gas and refrigerant.
- 9) Please scrap according to local regulations regarding disposal of the appliance for its flammable refrigerant and blowing gas. Before you scrap the appliance, please take off the doors to prevent children trapped.
- 10) This appliance is intended to be used in household and similar applications such as
 - staff kitchen areas in shops, offices and other working environments;
 - farm houses and by clients in hotels, motels and other residential type environments;
 - bed and breakfast type environments;
 - catering and similar non-retail applications.
- 11) Do not use an extension cord with this appliance. If the power cord is too short, have a qualified electrician or service technician install an outlet near the appliance. Use of an extension cord can negatively affect the performance of the unit.



IT IS HAZARDOUS FOR ANYONE OTHER THAN AUTHORISED SERVICE PERSONNEL TO CARRY OUT SERVICING OF REPAIRS WHICH INVOLVE THE REMOVAL OF COVERS.



TO AVOID THE RISK OF AN ELECTRICAL SHOCK DO NOT ATTEMPT REPAIRS YOURSELF.

2.INSTALLATION

2.1 Location

When selecting a position for your unit you should make sure the floor is flat and firm, and the room is well ventilated. Avoid locating your unit near a heat source, e.g. cooker, boiler or radiator. Also avoid direct sunlight as it may increase the electrical consumption. Extreme cold ambient temperatures may also cause the unit not to perform properly. This unit is not designed for use in a garage or outdoor installation. Do not drape the unit with any covering.

When installing the unit, ensure that 40 cm of free space is left at both sides, 15 cm at the rear and 20 cm at the top of the unit. This will allow cold air to circulate around the wine cooler and improve the efficiency of the cooling process. The door can be opened to the right or the left, depending on what better suits the location. Please ensure there is adequate space for the door to fully open.

2.2 Reversing the Door Swing

Tools Required: Phillips style screwdriver / Flat blade screwdriver / Hexagonal spanner



◆ If you want to have the door swing reversed, we recommend that you contact a qualified technician. You should only try to reverse the door yourself if you believe that you are qualified to do so.

- ◆ Ensure the unit is unplugged and empty.
- ◆ Adjust the two levelling feet to their highest position.
- ◆ To take the door off it is necessary to tilt the unit backwards. You should rest the unit on something solid so that it will not slip during the door reversing process.
- ◆ All parts removed must be saved to do the reinstallation of the door.
- ◆ Do not lay the unit flat as this may damage the coolant system.
- ◆ We recommend that 2 people handle the unit during assembly.

- 1) Start by removing the bracket from the bottom of the refrigerator. Unscrew the two screws from the bottom bracket. Remove the foot from opposite side.

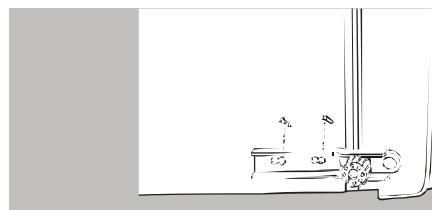

- 2) Self-Tapping Screws/Bottom Bracket/Foot

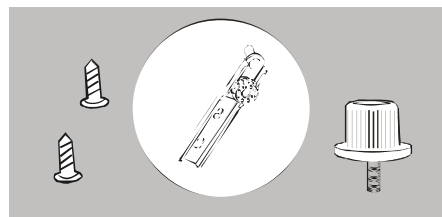

- 3) Slide the door down, away from the hinge pin located on the top of the door.

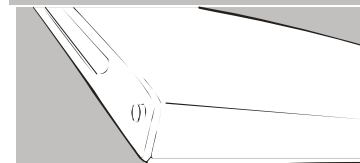

4) Remove the plastic cover from door hinge first. Then unscrew the two screws from top bracket and replace on the other side.

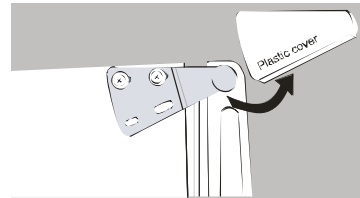

5) To install the bracket on the left side of the appliance, screw the two screws through the bracket and into the top of the appliance. Slide the door back on to the top hinge. Ensure the door is face up. Replace the plastic cover on the top bracket by pressing down until it clicks into position.

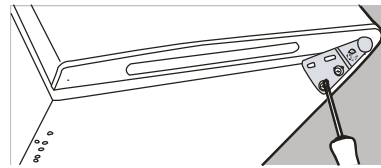

6) Screw the bottom hinge into place on the new side. Replace the foot on the other side.



7) Check that the door is aligned horizontally and vertically and that the seals are closed on all sides before finally tightening the bottom hinge. Re-adjust the levelling feet.

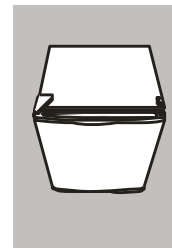

2.3 Door Space Requirements

The unit's door must be able to open fully as shown.

$W \times D \geq 37.01 \text{ inch} \times 33.86 \text{ inch}$

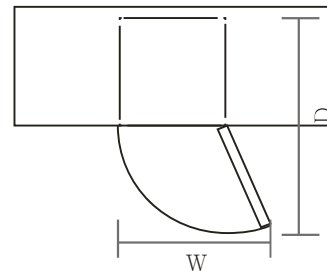

2.4 Levelling the Unit

To do this adjust the two levelling feet at the front of the unit. If the unit is not level, the door and magnetic seal alignments will not be covered properly.

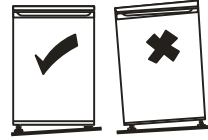

2.5 Cleaning Before Use

Wipe the inside of the unit with a weak solution of bicarbonate soda. Then rinse with warm water using a 'Wrung-out' sponge or cloth. Wash the shelves and salad bin in warm soapy water and dry completely before replacing in the unit. Clean the exterior of the unit with a damp cloth. If you require more information refer to the Cleaning section.

2.6 Before Using Your Unit

Before placing any food in your unit, turn it on and wait for 24 hours, to make sure it is working properly and to allow it time to fall to the correct temperature. Your unit should not be overfilled.



◆ **Before Plugging in**

You must check that you have a socket which is compatible with the plug supplied with the unit.

◆ **Before Turning On!**

Do not turn on until two hours after moving the unit. The coolant fluid needs time to settle.

2.7 Interior Accessories

Various glass or wire storage shelves are included with your appliance - different models have different combinations.

Please do the same in reverse to insert the shelf at a different height.



In order to make the most of the volume of the fresh food storage compartment and frozen-food storage compartment, the user can remove one or more shelves, drawers, out of the appliance, according to your daily use.

3. PRODUCT OVERVIEW

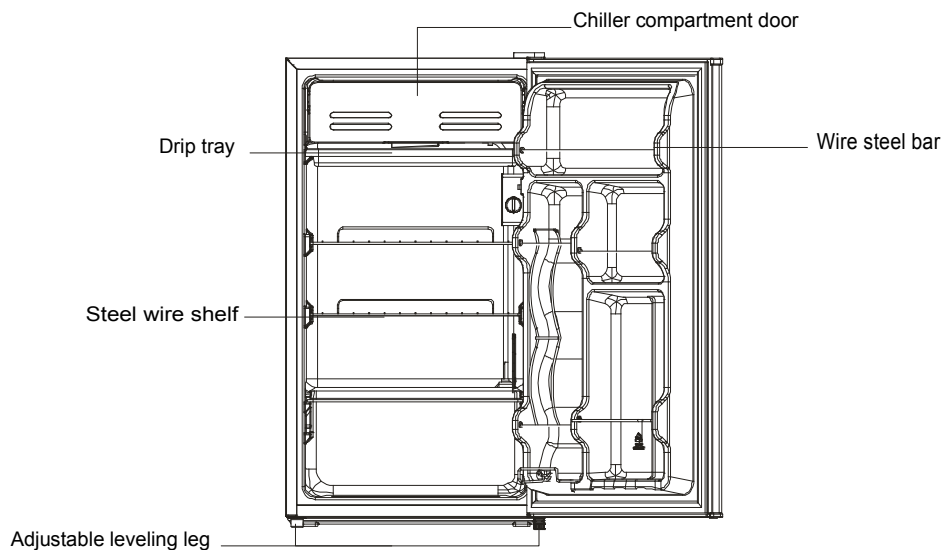

*All images in this instruction manual are for indication only; please refer to your individual unit for details.

4. OPERATION

4.1 Switching On Your Unit

◆ The temperature selector knob is located on the right hand side wall of the refrigerator interior

Setting “Off”: Unit Off

Setting “Min”: Less Cool Temperature

Setting “Med”: Normal Operation (adequate for most situations)

Setting “Max”: Coolest Temperature

◆ During high ambient temperatures e.g. on hot summer days. It may be necessary to set the thermostat to the Coolest setting (position “Max”). This may cause the compressor running continuously in order to maintain a low temperature in the cabinet.

◆ For the first time you install your refrigerator, set the thermostat knob at “Med”.

Give your refrigerator time to cool down completely before adding food. It is the best to wait 24 hours before adding food. The thermostat knob controls the temperature. When the thermostat control knob is set to OFF, the refrigerator will not be running.

4.2 Noise Inside the Unit

You may notice that your unit makes some unusual noises. Most of these are perfectly normal,

but you should be aware of them!

These noises are caused by the circulation of the refrigerant liquid in the cooling system. It has become more pronounced since the introduction of CFC free gases. This is not a fault and will not affect the performance of your unit. This is the compressor motor working, as it pumps the refrigerant around the system.

4.3 Tips for Keeping Food in the Unit

- ◆ Cooked meats/fishes should always be stored on a shelf above raw meats/fishes to avoid bacterial transfer. Keep raw meats/fishes in a container which is large enough to collect juices and cover it properly. Place the container on the lowest shelf.
- ◆ Leave space around your food, to allow air to circulate inside the unit. Ensure all parts of the unit are kept cool.
- ◆ To prevent transfer of flavors and drying out, pack or cover the food separately. Fruit and vegetables do not need to be wrapped.
- ◆ Always let pre-cooked food cool down before you put in the unit. This will help to maintain the internal temperature of the unit.
- ◆ To prevent cold air escaping from the unit, try to limit the number of times you open the door. We recommend that you only open the door when you need to put food in or take food out.

5. CLEANING

5.1 Defrosting

Frost may accumulate on the inner rear surface of the appliance which will automatically defrost during the off cycle of the compressor. Water is channelled via the drain hole to the collection tray above the compressor where it will evaporate.

Please ensure the drain hole is checked and cleaned on a regular basis so water can exit the storage compartment.

Do not use Mechanical Devices to Defrost refrigerator.

5.2 Cleaning the Interior and the Exterior of the Unit

- ◆ Remove all the shelves and the salad bin. To remove the salad bin first remove the lower door shelf.
- ◆ Wipe the inside of the unit with a weak solution of bicarbonate soda and then rinse with warm water using a “wrung-out” sponge or cloth. Wipe completely dry before replacing the shelves and salad bin.
- ◆ Use a damp cloth to clean the exterior, and then wipe with a standard furniture polish. Make sure that the door is closed to avoid the polish getting on the magnetic door seal or inside the unit.
- ◆ The grille of the condenser at the back of the unit and the adjacent components can be vacuumed using a soft brush attachment.

5.3 Cleaning Tips

Condensation may appear on the outside of the unit. This may be due to a change in room

temperature. Wipe of any moisture residue. If the problem continues, please contact a qualified technician for assistance.

6. MAINTENANCE

6.1 Care When Handling/Moving Your Unit

Hold the unit around its sides or base when moving it. Under no circumstances should it be lifted by holding the edges of the top surface. Avoid damaging the refrigerant tubing when handling, moving and use of refrigerator.

6.2 Servicing

The unit should be serviced by an authorized engineer and only genuine spare parts should be used. Under no circumstances should you attempt to repair the unit yourself. Repairs carried out by inexperienced persons may cause injury or serious malfunction. Contact a qualified technician.

6.3 Switching off for Long periods of Time

When the unit is not in use for a long period of time, disconnect it from the mains supply, empty all food and clean the appliance, leaving the door ajar to prevent unpleasant smells.

7. TROUBLE SHOOTING

The following simple issues can be handled by the user. Please call the after-sale service department if the issues are not settled.

| | |
|---------------------------------------------------|--------------------------------------------------------------------------------------------------------------------------------------------------------------------------------------------------------------------------------------------------------|
| Odor | Odorous foods should closely wrapped; Whether foods are rotten; Whether the interior shall be cleaned. |
| Long-term operation of compressor | It is normal that refrigerator operates for longer time in summer when the ambient temperature is higher; Do not put too much food in the freezer at one time; Do not put foods until they are cooled; Frequent opening of refrigerator door. |
| The refrigerator door can not be properly closed. | The freezer door is stuck by food packages; Too much food; Tilt refrigerator. |
| Loud noises | Whether the food is leveled, whether the refrigerator is balanced; |

7.1 Warm tips:

- ◆The refrigerator enclosure may emit heat during operation specially in summer, this is caused by the radiation of the condenser, and it is a normal phenomenon.
- ◆Condensation: condensation phenomenon will be detected on the exterior surface and door seals of the freezer when the ambient humidity is large, this is a normal phenomenon, and the condensation can be wiped away with a dry towel.
- ◆Buzz: Buzz will be generated by running compressor specially when starting up or shutting down.

Limited Warranty



DAEWOO ELECTRONICS AMERICA INC. warrants the following Refrigerators to be free from defective material and workmanship and agrees to remedy any such defect or to furnish a new part (at the Company's option) in exchange for any part of any unit of its manufacture which under normal installation, use and service disclosed such defect, provided the unit is delivered by the owner to us or to our authorized distributor from whom purchased or authorized service station, intact, for our examination with all transportation charges prepaid to our factory. To establish and receive warranty service at our factory or authorized service facilities, a sales receipt or bill of sales is required for proof of purchase.

Written authorization must be obtained before any merchandise is returned to the factory.

This warranty does not extend to any of our electronic products which have been subjected to misuse, neglect, accident, incorrect wiring not our own, improper installation, unauthorized modification, or to use in violation of instructions furnished by us, nor units which have been repaired or altered outside of our factory, nor to cases where the serial number there of has removed, defaced, or changed.

This warranty is in lieu of all warranties expressed or implied and no representative or person is authorized to assume for us any other liability in connection with the sales of our electronic products.

For units that are initially defective.

Initial defective is described as when the dealer opens the unit and finds that it is inoperative or an individual customer opening a new unit and finding that it is initially defective. This unit may be returned to the factory by the dealer for exchange. Under no circumstances will an individual customer be permitted to return defective unit directly to factory. Exchange must be directly with the dealer. When this unit is returned to dealer, a copy of the purchase evidence stating the date of purchase is to be put in the individual box for dealer's further control with the factory.

| <u>MODEL</u> | <u>PARTS</u> | <u>LABOR</u> | <u>COMPRESSOR</u> |
|---------------------------------------------------------------|--------------|--------------|-------------------|
| Refrigerator | 1 year | 1year | 5years |
| Model: FR-033RVBE (compact refrigerator for MF-9B033B) | | | |

Note: **For Service or Assistance, please call:**

1-877-DWESVC3 (1-877-393-7823) www.daewooelecusa.com