

Features

- Two cross handles offer separate control of hot and cold water
- Part of the Occasion bathroom faucet and accessory collection
- UltraGlide® valves with dry-stem technology are designed to eliminate common leak paths and provide smooth, effortless control

Material

- Premium metal construction for durability and reliability
- KOHLER finishes resist corrosion and tarnishing

Installation

- For 8" – 16" (203 – 406 mm) centers
- Deck-mount
- Handles are preassembled on valves to simplify installation

Required Products/Accessories

For above-counter installation

- K-27008 Bathroom sink faucet spout with Cane design, 1.2 gpm
- K-27008-K Bathroom sink faucet spout with Cane design, 1.0 gpm
- K-27008-N Bathroom sink faucet spout with Cane design, 0.5 gpm
- K-27009 Bathroom sink faucet spout with Straight design, 1.2 gpm
- K-27009-K Bathroom sink faucet spout with Straight design, 1.0 gpm
- K-27009-N Bathroom sink faucet spout with Straight design, 0.5 gpm

Recommended Products/Accessories

- K-27060 18" towel bar
- K-27061 24" towel bar
- K-27062 24" double towel bar
- K-27063 Towel ring
- K-27064 Vertical toilet paper holder
- K-27065 Pivoting toilet paper holder
- K-27069 Robe hook
- K-27128 Toilet paper holder with tray



ADA CSA B651 OBC

Codes/Standards









ASME A112.18.1/CSA B125.1
NSF/ANSI/CAN 61
NSF/ANSI/CAN 372
ADA
ICC/ANSI A117.1
CSA B651
OBC

KOHLER® Faucet Lifetime Limited Warranty

See website for detailed warranty information.

Available Colors/Finishes

Color tiles intended for reference only.

Color	Code	Description
	CP	Polished Chrome
	SN	Vibrant® Polished Nickel
	AF	Vibrant® French Gold
	BN	Vibrant® Brushed Nickel
	BV	Vibrant® Brushed Bronze
	BL	Matte Black
	2MB	Vibrant® Brushed Moderne Brass
	BMB	Matte Black with Moderne Brass
	TT	Vibrant Titanium

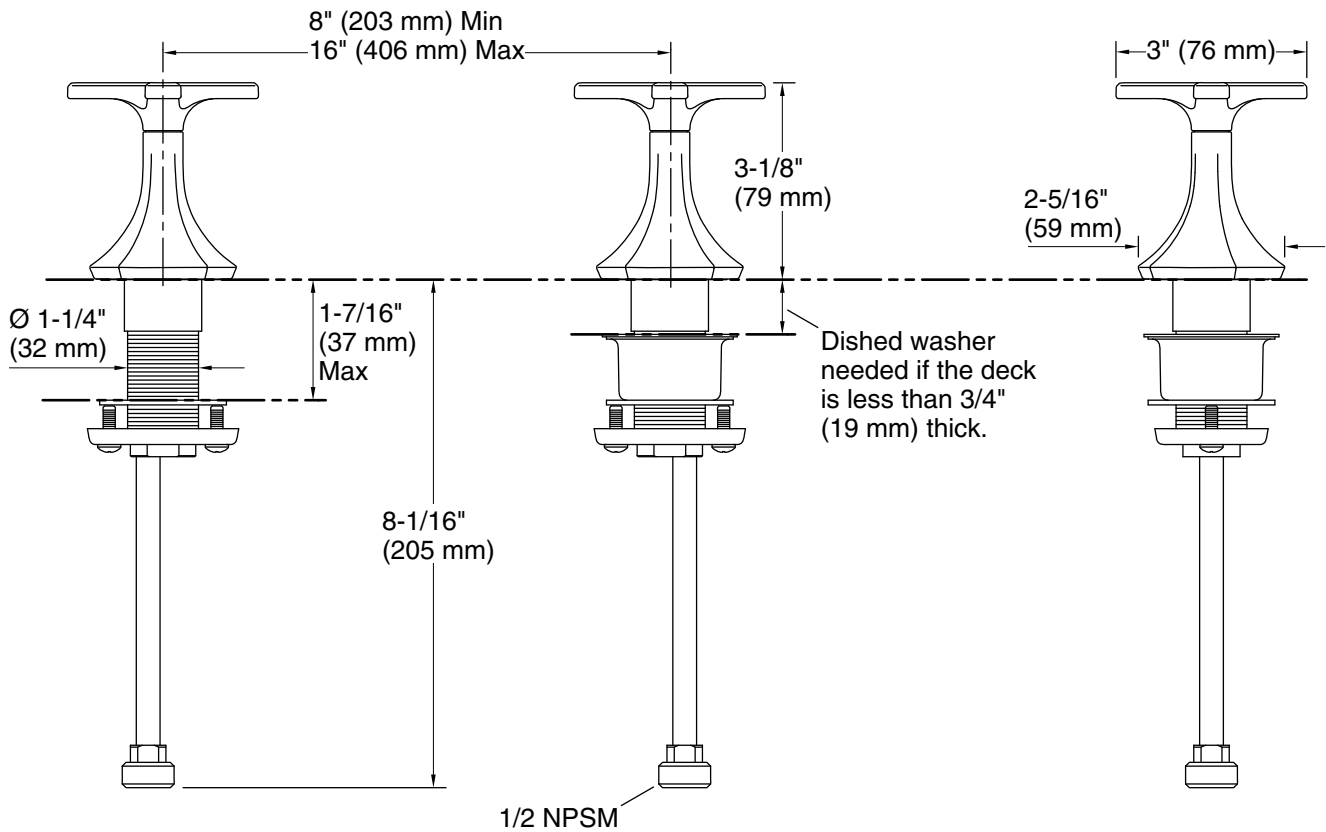

Technical Information

All product dimensions are nominal.

Faucet flow rate: 1.2 gal/min (4.5 l/min)

Drain with overflow: Yes

Drain tailpiece included: No

Spout:

Notes

Install this product according to the installation instructions.

ADA, OBC, CSA B651 compliant when installed to the specific requirements of these regulations.