

Oaks Aura Modern Ceiling Fan  
**Installation & Troubleshooting Manual**

**CAUTION**  
**READ INSTRUCTIONS CAREFULLY FOR**  
**SAFE INSTALLATION AND FAN OPERATION**

## CONTENT

INTRODUCTION .....	1
INSTALLATION .....	2
CLEANING AND MAINTENANCE .....	4
REMOTE CONTROLLER SETTING .....	5
CELLPHONE APP SETTING .....	6
PRODUCT FEATURES .....	9
SAFETY PRECAUTIONS .....	10
TROUBLESHOOTING .....	11



## INTRODUCTION

**THIS HUMHOLD CEILING FAN LIGHT IS MANUFACTURED WITH GREAT CARE, AND UTILIZES THE LATEST IN TECHNOLOGY. WE ARE CONFIDENT THAT YOU WILL BE FULLY SATISFIED WITH IT'S PERFORMANCE AND RELIABILITY. IT PROVIDES EXACT INSTRUCTIONS FOR INSTALLATION, OPERATION AND MAINTENANCE, AND ALSO SUPPLIES SOME USEFUL HINTS.**

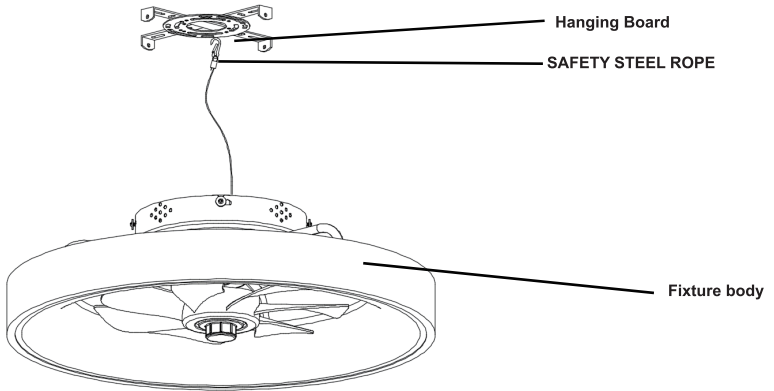

REMOTE X1



SCREW ACCESSORY SET

Note: The illustrations of the product, accessories in this manual are schematic diagrams for reference only. Due to the update and upgrade of the product, the physical product may be slightly different from the schematic diagram. Please take the physical product as the standard.

## INSTALLATION

1. Open the package, take out the fan lamp, press down the base, and rotate to remove the base;

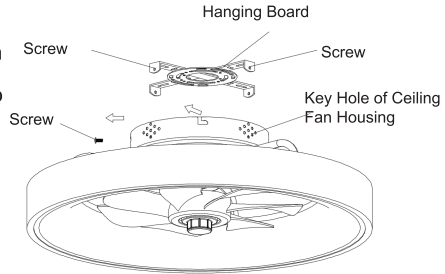

2. Take off the safety steel rope.

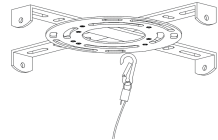

3. Base installation

Fix the lamp base on the ceiling mounting base with screws, and confirm that the base is firmly installed. (If there's no mounting base on the ceiling, use an electric drill to drill installation holes on the ceiling, put the expansion pipe into the installation hole)

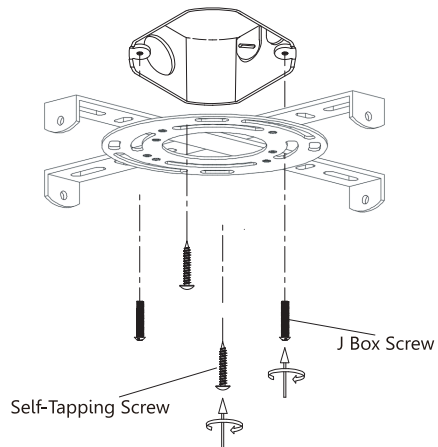

4. Buckle up the safety steel rope

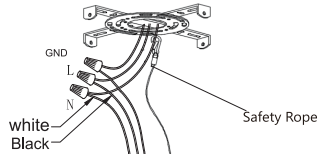

5. Wiring

Use wiring caps to connect the L/N/Ground wires. (Make sure the power is OFF before wiring)

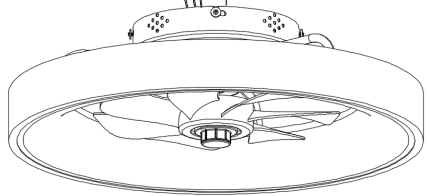

6. Hold the edges of both sides of the lamp body with both hands, align with the base, gently push both sides upward and rotate clockwise at the same time. After hearing the "click", then install the safety screw on the side of the lamp body, and make sure the lamp body cannot rotate after installation. The installation is completed.

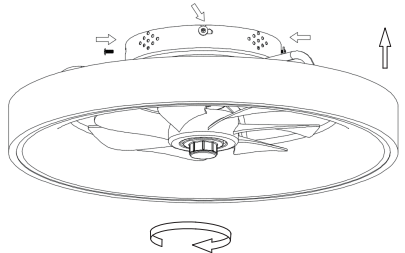

## CLEANING AND MAINTENANCE

1. Remove the safety screw on the side of the lamp body, hold the fan lamp with both hands, push it upward and rotate it counterclockwise to remove the fan lamp body.
2. Remove the wiring caps, disconnect the wires, and remove the safety steel rope.
3. According to the opening sign of the protective net and fan blade, it can be cleaned after opening and taking out.

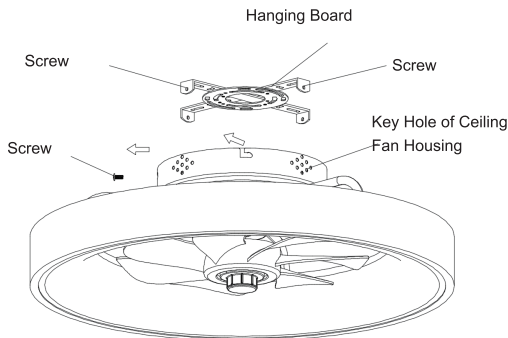

Note: Do not flush the lamp body with water directly. After the fan lamp is cleaned, please dry it first. To avoid the risk of falling, please confirm the parts are installed correctly.

### WARNING

Always switch off the power prior to cleaning in the vicinity of electrical parts (lamps, fan blades etc.). Wipe up excess moisture with a sponge or cloth to prevent water or liquid from getting into any electrical part and causing a electric shock. Do not use flammable or toxic cleaning liquids.

## REMOTE CONTROL INSTRUCTIONS

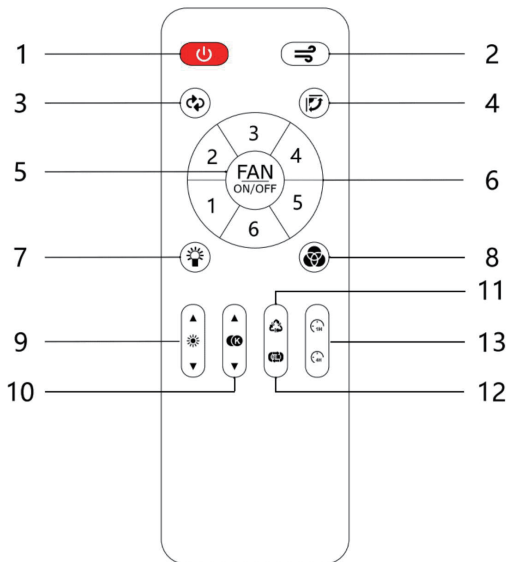

### 2.1. Pair code

Connect the device to the power supply and confirm that the device can work normally (the light turns on slowly);

Turn off the power of the device for 5~10 seconds and then turn on the power again;

Long press Button 1 until the device flashes 3 times quickly, then let go;

The code pairing of the remote control is successful. At this time, you can press the button to control the device.

### 2.2. Clear code

Connect the device to the power supply and confirm that the device can work normally (the light turns on slowly);

Turn off the power of the device for 5~10 seconds and then turn on the power again;

Long press Button 2 until the device flashes 3 times quickly, then let go;

The remote control is successfully cleared. At this time, the remote control can no longer control the device and needs to be re-paired before it can be used.

### 2.3. control#



Button 1: All off, short press to turn off the main light & color light & fan;

Button 2: Fan mode, short press to switch between natural and comfortable wind;

Button 3: Fan direction, short press to switch between forward and reverse;

Button 4: fan rocker switch, only some models support this function;

Button 5: Fan switch, short press to turn on/off the fan, long press the button for 5 seconds to enable the device to enter the App distribution network mode;

Button 6: Fan speed, short press to adjust the speed of 6 levels

Button 7: White light switch, short press to turn on/off the white light;

Button 8: Color light switch, short press to turn on/off color light;

Button 9: Brightness addition and subtraction, short press to adjust the brightness of 10 levels, and long press to adjust the brightness steplessly;

Button 10: Addition and subtraction of temperature, short press to adjust the 10-level temperature, long press to adjust the temperature steplessly;

Button 11: Color static cycle switching (red, yellow, green, blue, purple, white);

Button 12: Color dynamic cycle switching;

Button 13: 1 hour/4 hours countdown timer off, fan & white light & color light all off at the same time;

## Download and install App

rt Life" in application market to download

Use your phone to scan the QR code below or search "Smart Life" and install the App.



## APP CONTROL

### IMPORTANT:

!!! Turn on BLUETOOTH on your phone !!!

Two method to put the light into pairing mode:

1. Turn light ON-OFF-ON-OFF-ON, when the ceiling fan light is flashing, it is on paring process.
2. Long press  on the remoter 5 seconds, when the ceiling fan light is flashing, it is on paring process.

Now you can operate on your phone:

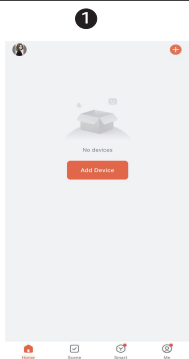

Click "add device" or "+" to add new device

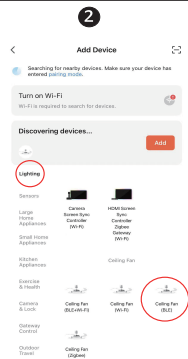

Adding device auto/manually:  
Lighting-Ceiling fan(BLE)

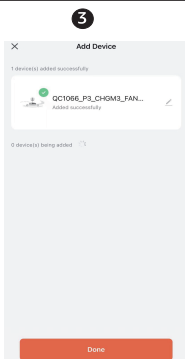

Successfully added

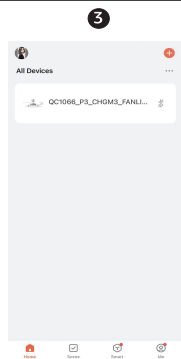

Click on the device to enter setting interface.

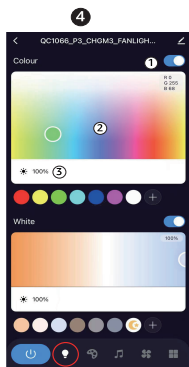

1. Turn on the back light source
2. Color temperature selection (back light source)
3. Brightness adjustment

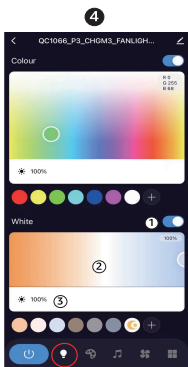

1. Turn on the front light source
2. Color temperature selection (front light source)
3. Brightness adjustment

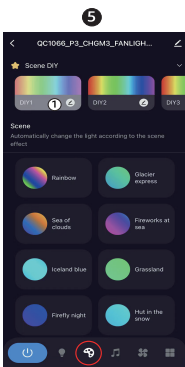

1. Customize your own scenes.
2. Scene selection. (42 adjustable lighting variations)

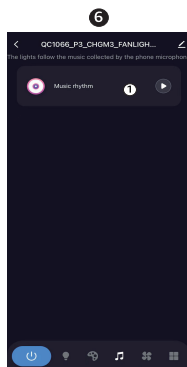

1. Music rhythm

APP CONT

**7**

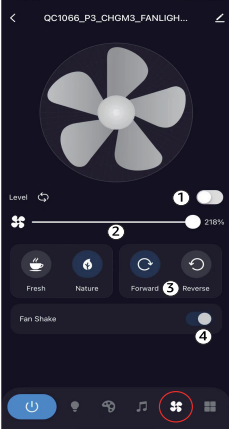

1. Fan on/off
2. Fan speed
3. F/R rotation
4. Fan shade mode on/off

**8**

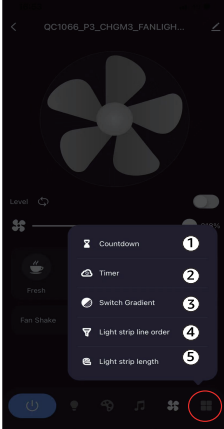

1. Countdown
2. Timer
3. Switch Gradient
4. Light strip line ord
5. Light strip length

**9**

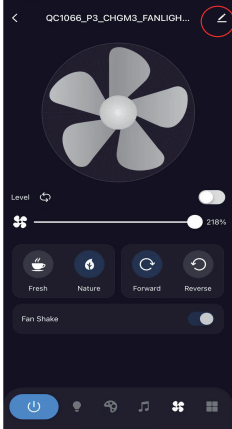

**Edit**

**9**

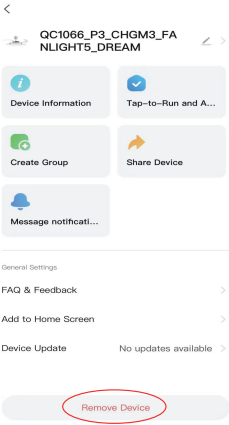

**Remove device**

**9**

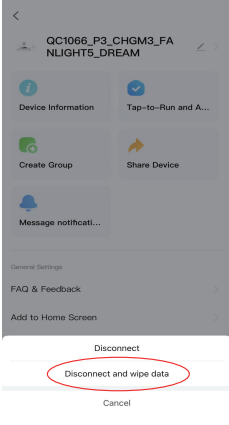

**Disconnect and**

**9**

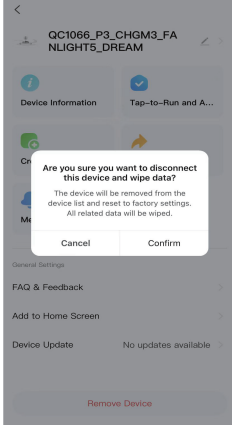

**Confirm**

## PRODUCT FEATURES



COLOR ADJUSTMENT



BRIGHTNESS ADJUSTMENT



NIGHT MODE



CELLPHONE  
APP CONTROL



TIMING FUNCTION



FAN SPEED SETTING



REVERSIBLE



EASY INSTALL

## SAFETY PRECAUTIONS

1. Please confirm whether the voltage meets the working voltage of the product before use. Using inappropriate voltage may damage the product and cause potential safety hazards;
2. The light source of this lamp is a non user replacement light source, and the light source in this lamp shall be replaced by the manufacturer or its service agent or a person with similar qualification;
3. During the operation of the fan, do not touch the fan blade to avoid danger;
4. The installation height of fan lamp shall be more than 2.3m above the ground;
5. The lamp can be controlled by the remote controller and mobile phone software. After the lamp is turned off by the remote controller or mobile phone software, it does not mean that the power supply is actually cut off. In this case, it is forbidden to touch, replace or disassemble the lamp, otherwise it may cause electric shock and even casualties.



Before installation, be sure to cut off the power supply to prevent electric shock. During installation, the operation shall be carried out in strict accordance with the instructions. If the installation is improper, it is easy to cause accidents such as fire, electric shock or lamp body falling.



Please entrust electrical professionals to install or repair. The wiring shall comply with electrical standards or national standards to avoid danger.

## TROUBLESHOOTING

**IF YOU FEEL YOUR CEILING FAN LIGHT IS NOT OPERATING PROPERLY, CHECK THESE POSSIBLE CAUSES:**

PROBLEM	POSSIBLE CAUSES
CEILING FAN DOES NOT OPERATE	<ul style="list-style-type: none"> <li>⌘ Has a house fuse blown or circuit breaker tripped?</li> <li>⌘ Check whether the power switch out of order.</li> </ul>
LIGHT IS ON, BUT THE REMOTE DOESN'T WORK	<ul style="list-style-type: none"> <li>⌘ The remote's batteries are weak, change the batteries of the remote controller.</li> <li>⌘ The remote lost the pairing code. Please re-pair the remote with the unit according to the instruction of pairing steps .</li> </ul>
LIGHT WABBLES WHEN THE FAN IS ON	<ul style="list-style-type: none"> <li>⌘ Has the light base/crosshanger been loosened from the ceiling?</li> <li>⌘ The fan blade is uneven, tighten the blade to the motor.</li> </ul>
CANNOT CONNECT THE APP	<ul style="list-style-type: none"> <li>⌘ Is the App the newest version?</li> <li>⌘ Has the Bluetooth function been turned on?</li> </ul>
FAIL TO CONTROL THE LIGHT	<ul style="list-style-type: none"> <li>⌘ Please check whether the remote out of order.</li> </ul>

## TECHNICAL SUPPORT

For technical support issues please visit [www. OaksAura.com](http://www.OaksAura.com) order page, our online technical support team members will answer your questions.

Please feel free to contact us: [Support@OaksAura.com](mailto:Support@OaksAura.com)