

Wetwall™
— A WILSONART COMPANY —



Water-Proof
Wall Panel System
PATENTED TECHNOLOGY



WETWALL INSTALLATION GUIDELINES

REQUIRED TOOLS AND MATERIALS

Wetwall Installation

TOOLS

- Pencil
- Drill
- Hole Saw
- Circular Saw
- Chalk-Line
- Router
- Tape Measure
- Heavy Duty Caulking Gun
(Ideal for knife-grade adhesives)
- Level
- Square
- Suction Cups

MATERIALS

- Denatured Alcohol

INCLUDED MATERIALS

- Wetwall Panel Adhesive
- Wetwall Color Matched Sealant

PERSONAL PROTECTIVE EQUIPMENT RECOMMENDATION

- Dust Mask
- Safety Goggles
- Protective Gloves
- Protective Footwear

GUIDED INSTRUCTIONAL VIDEO

- [Click here](#) for guided installation video.

PREPARATION

Wetwall Installation

BEFORE YOU BEGIN

To ensure this product is installed properly, please read these instructions carefully before you begin. (Certain installations may require professional help.) Also be sure your installation conforms to local codes.

- Local building codes vary by location. Observe all local plumbing and building codes.
- Unpack the Wetwall panels and inspect them carefully for damage. Verify that the walls are the correct size for your installation. Refer to Wetwall Technical Data sheet for specific dimensions for each model.

NOTE: Take extra care in handling the front surfaces of the panels. Use only non-abrasive cloths to avoid scratching.

PREPARATION

Must be installed over SHEETROCK/GREENBOARD, CEMENT/CONCRETE or TILE.

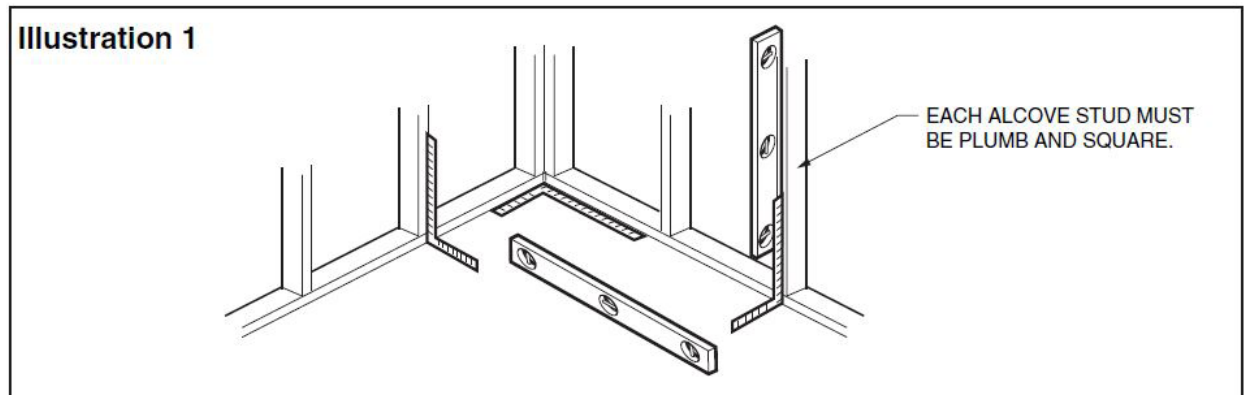

EXISTING WALL SURFACE PREPARATION

- Ensure wall surface is dry, smooth, and free of dust, soap scum, mold or other contaminants. Wipe wall surfaces with a damp cloth and allow to dry.
- Wall surface must be dry before panels can be applied.
- Ensure that alcove is plumb and square. (See Illustration 1)

ROUGH PLUMBING & FITTING

- Turn off hot and cold water supplies.
- Remove faucet handles, escutcheons, filler spouts and any other fixtures. (e.g. towel bars, soap dishes, etc.).
- Use a hammer and chisel to remove objects cemented to walls.

INSTALLATION OVER OLD TILE

- Old ceramic tiles, if solidly adhered to walls, need not be removed. Loose ceramic tiles must be removed and sub walls sanded smooth.
- Rough up glossy tile surfaces using belt sander with 60-grit sandpaper.
- Surface must be dry, smooth and free of any dust or any other contaminants.
- Wipe wall surfaces with a damp cloth and allow to dry.

IF YOU PLAN TO INSTALL A SHOWER DOOR

- Follow manufacturer's instructions and prepare stud wall accordingly.

DRY FITTING TONGUE AND GROOVE

Wetwall Installation

Dry Fitting Tongue and Groove Panels on the Wall

STEP 1.

- Dry fit the panels starting with the rear most panels first. Keep a 1/8" (3mm) gap above the tub deck or shower base for all panels. Mark seam or joint location with a pencil on the wall (drywall) to be used later for panel adhesive reference.
- When connecting several panels together, use a tongue and groove system to connect each panel. (See Illustration 2)
- Suction cups will aid in the handling and installation of the wall panels. They will also aid in drawing seams together during the installation.

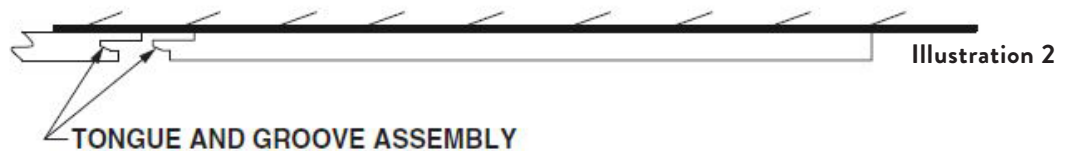

STEP 2.

- Dry fit the two side panels next.
- On one side of the panel is a finished or reveal edge that can be installed on the outside or entrance edge of the shower to give a finished look not requiring standard wall trim. (See Illustration 3)
- If the wall or tub is out of square, trim or cut from bottom edge of side panels so that the top edge of the panels are level with the top edge of the back panels.

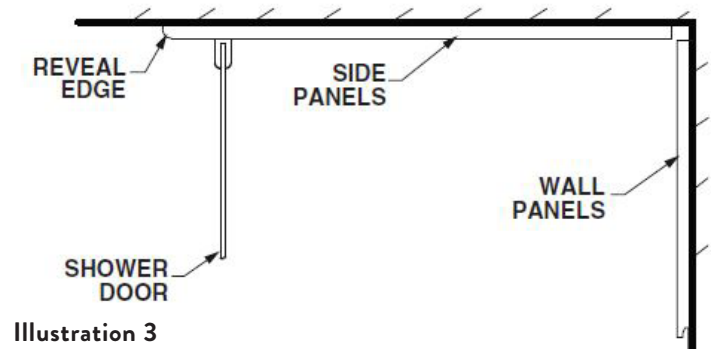

STEP 3.

- Once both side panels are properly dry fitted, mark all plumbing locations where shower valves or shower heads come through the side panel.
- Drill holes at each location using a hole saw large enough to accommodate the opening but small enough to be covered by the trim plates.
- Drill from the decorative side. (See Illustration 4)

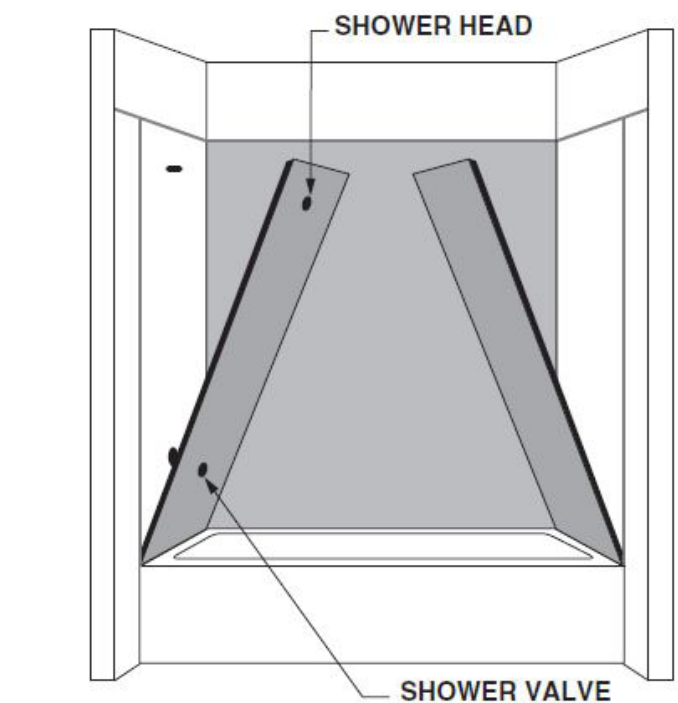

WETWALL PANEL ADHESIVE APPLICATION

PANEL ADHESIVE APPLICATION

Wetwall Installation

Applying Panel Adhesive To Drywall and Tongue and Groove Panels

NOTE: DO ONLY ONE WALL AT A TIME

STEP 1.

- Wipe all back sides of panels and walls with a damp cloth to remove any dust or debris and allow to fully dry.

STEP 2.

- Starting with the rear or back panels, apply panel adhesive on the wall (drywall) starting with an adhesive bead being applied 1 ½" (38mm) from each edge of each separate panel location. (See Illustration 5)
- Panel adhesive beads must be approximately ¼" (5mm) wide and deep in size. For each panel apply additional panel adhesive beads evenly spaced between the first two beads at approximately 10"– 12" (250–304mm) apart.
- Kits are available in sizes 60" x 30" x 72", 60" x 30" x 96", 60" x 32" x 72", 60" x 32" x 96", 36" x 34" x 72", 36" x 34" x 96", 48" x 34" x 72", and 48" x 34" x 96".
- Apply one row of adhesive horizontally across the top and bottom each ½" (13mm) from the edge. Apply color matched sealant to both tongue and groove of the panels.

NOTE: Use of a heavy duty caulking gun is recommendation for knife grade adhesives.

STEP 3.

- With the aid of suction cups, move first rear panel onto the wall keeping a space of approximately 1/8" (3mm) off the flange surface of the tub deck or shower base. Press panel firmly over entire surface to ensure firm contact of panel to adhesive on wall.

NOTE: It may be necessary to brace or support the panels against the wall until the panels stay securely in place. (See Illustration 6)

STEP 4.

- Apply panel adhesive as in Step 2. Place second rear panel on wall and snap into place, the tongue and groove of the first panel keeping approximately 1/8" (3mm) gap between bottom of panel and tub flange. Do not force or tap the groove edge to close the joint. Press firmly over entire area of panel to securely hold in place. Wipe any excessive adhesive that comes out between the tongue and groove with denatured alcohol.

STEP 5.

- Apply side panels in the same manner keeping the finished reveal edge to the outside or entrance of the tub or shower pan using the same adhesive pattern. Provide a gap of approximately 1/8" (3mm) in the corners between the side and rear panels to accommodate adhesive. Wipe off any excessive adhesive with denatured alcohol.

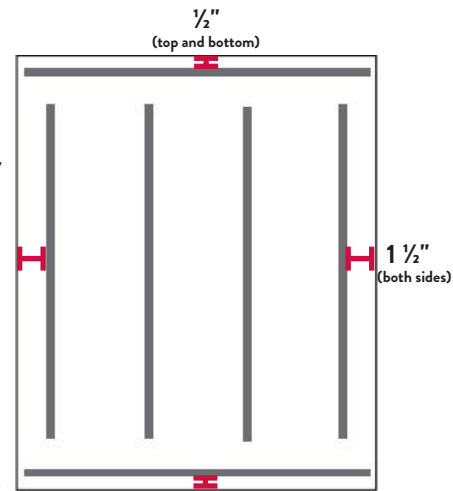

Illustration 5

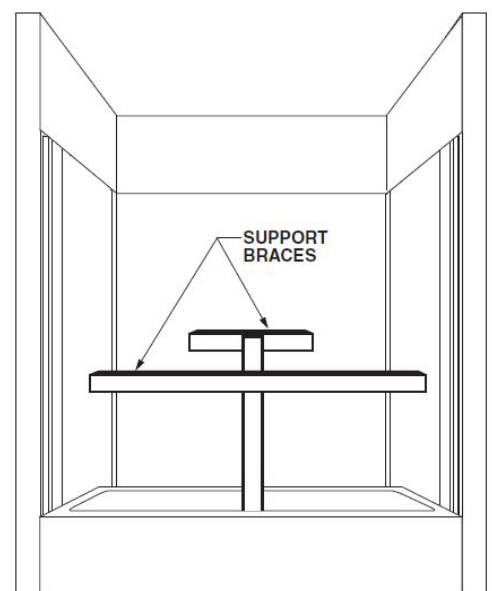

Illustration 6

WETWALL COLOR MATCHED SEALANT APPLICATION

COLOR MATCHED SEALANT APPLICATION

Wetwall Installation

Applying Color Matched Sealant For Seams and Joints

NOTE: Color matched sealant is colored or matched to the approximate color of panel being installed. This helps ensure sealant is not as visible.

STEP 1.

- Once all panels are securely in place and set, apply the color matched sealant to all corners, seams between panels and gaps between bottom panels and tub or shower pan. (See Illustration 7)

NOTE: Wipe any excess adhesive from the panel with denatured alcohol .

STEP 2.

- Allow panels to cure for 24 hours before installation of shower accessories.

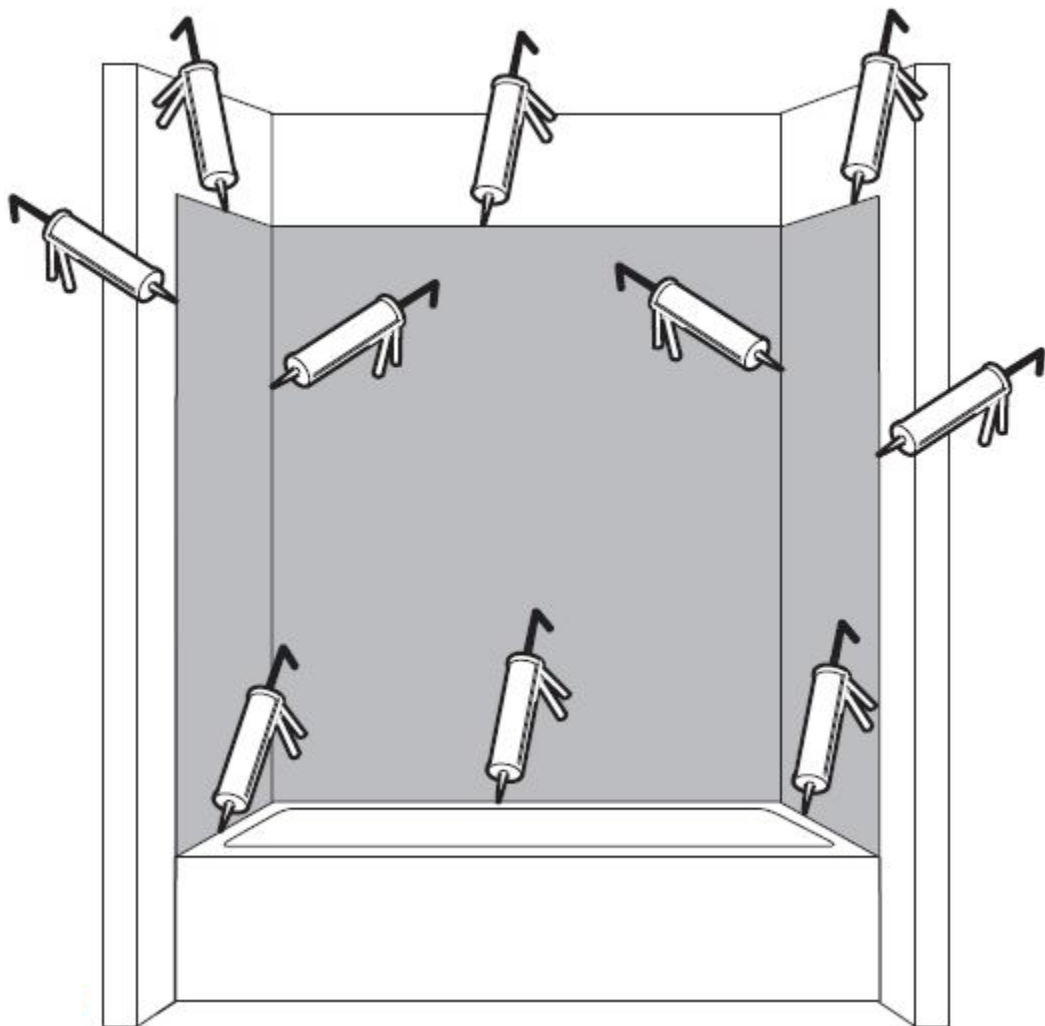

Illustration 7

ACCESSORY INSTALLATION

ACCESSORY INSTALLATION

Wetwall Installation

Installing Shower Heads, Handles, and Bath Spouts

STEP 1.

- Install the shower accessories per the manufacturer's instructions. Be sure to apply color matched sealant to all trim plates.

NOTE: Allow 24 hours for the color matched sealant to dry before use.

Installing Shower Shelves, Doors and Curtain Rods

FOLLOW MANUFACTURER'S INSTRUCTIONS.

IMPORTANT: Apply color matched sealant over the threads of mounting screws AND around outside of each wall anchor to seal out moisture and water. The shelf/shelves must be supported to the wall behind the Wetwall panel. Wetwall itself must not support the weight of the shelf/shelves.

CARE AND MAINTENANCE

Wetwall Installation

INSTALLATION CLEAN-UP

- Remove all construction debris. Tile grout can be removed with a wooden popsicle stick or tongue depressor. Do not use wire brushes or any other metal implement on surface.
- Post installation clean-up generally can be completed using warm water and liquid dishwashing detergent. Stubborn dirt or stains may be removed by using regular household cleaners and/or denatured alcohol.
- Denatured alcohol or acetone can be used to remove excess adhesive and/or wet oil-base paint. Be sure to rinse with soap and water immediately after.

CARE AND MAINTENANCE



WARNING: Cleaning products with labels that say “not suitable for use with ABS, acrylic or polystyrene” SHOULD NOT BE USED. Read all labels carefully.

- Excessively hot water (greater than 212 degrees) may cause surface damage.
- **HARSH CHEMICALS SHOULD NEVER BE USED ON WETWALL SURFACES.** Clean after use with a mild liquid household detergent cleaner. Do not use Lestoil®, Lysol® Disinfectant (spray or concentrate), or Lysol® Basin, Tub and Tile Cleaner, Mr. Clean®, Dow® Disinfectant Bathroom Cleaner, or cleaning products in aerosol cans.
- Do not use wire brushes, knives or sharp objects to remove stains, cigarette tar deposits, or other surface blemishes.
- Abrasive cleaners or powders must not be used, since they will dull the surface.
- Do not wax areas where you walk or stand.
- Do not allow nail polish remover, dry cleaning fluid, paint remover or other solvents to come into contact with the surface. For stubborn stains acetone can be used in moderation. Be sure to wash surface immediately after with soap and water.
- Clean the surrounding surface immediately after using caustic drain cleaners.
- Burning cigarettes will damage the surface.
- Should damage to the panels occur, repairs can be made quickly and easily. Your distributor or builder can provide details.

For additional information please follow the links below:

Wetwall Technical Data

Wetwall Warranty

[Wetwall Website](#)