

ASSEMBLY INSTRUCTION

12'x 20' STEEL DOUBLE ROOF GAZEBO

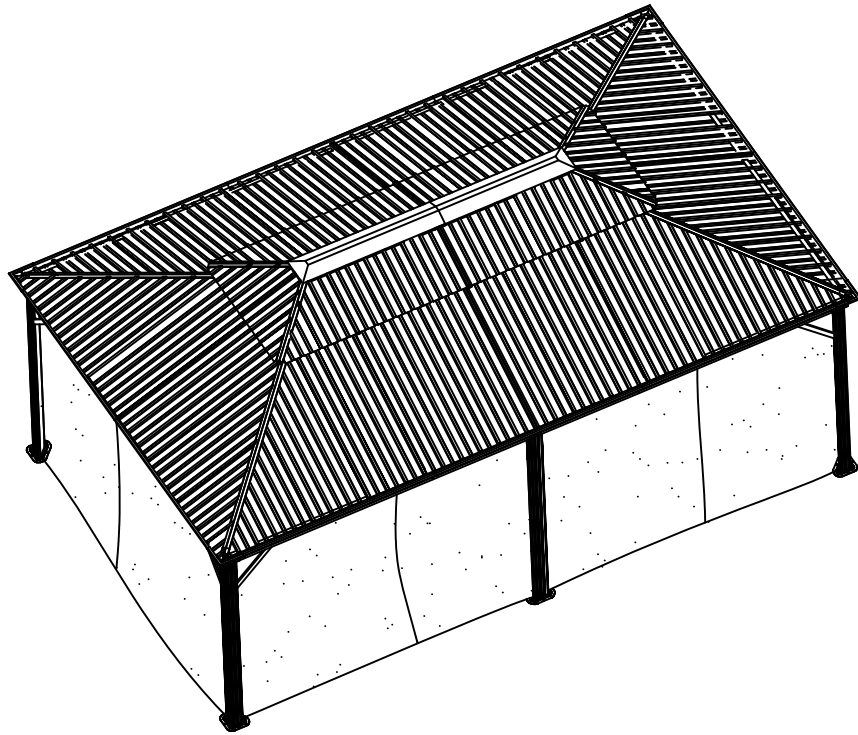

Important Safety Instructions



Warning! To reduce the risk of serious injury, read the following safety instructions before assembling and using the gazebo.

Please check with your local governing authority/local municipal codes regarding installation of structures before assembly.

Caution! Proper placement of your gazebo is essential.

Do not place the product underneath electrical lines.

Keep children away during assembly.

This product contains small parts which can be swallowed by children.

Keep fingers away from the places where they can be pinched or trapped.

Do not attempt to assemble the gazebo if any parts are missing.

- This product is intended for domestic outdoor use only.
- The product should be placed on flat, horizontal ground.
- Ensure enough clearance around the product. Before assembling the product, find level ground not less than 6' (1.8 m) away from any structures or obstructions, such as fences, garages, houses, overhanging branches, laundry lines, or electrical wires.
- This gazebo is not to be regarded as part of a building/house structure. The gazebo is to be anchored onto the ground for added safety. Do not assemble the gazebo onto soil/earth ground. It is best advisable to have the gazebo built onto a wooden deck or concrete ground for stability. If it is to be built onto a wooden deck/ground, do ensure that the wooden deck/ground has a strong foundation. It is advisable to use appropriate floor plugs (not provided) to anchor the gazebo onto the wooden/concrete ground.
- Some structures may require two or more people to install safely. Check for underground utilities before digging or driving stakes into the ground.
- During installation, follow all safety warnings provided with your tools, and use safety glasses.
- In case you set up more than one gazebo, keep a minimum distance of 10' (3 m) between the gazebos.
- Any assembly or maintenance of the product must be carried out by adults only.
- Arrange necessary manpower when assembling or moving the product.
- Some parts may contain sharp edges. Wear protective gloves if necessary.
- Keep children and pets away while setting up the gazebo.
- Check all nuts and bolts periodically to ensure bolts/nuts are tightened.
- Repairing and replacing parts should be done by a qualified technician.
- This gazebo is intended for decorative and sunshade purposes only, and it is not designed to withstand harsh weather, including high winds, rain, and snow.
- Do not light any fires inside or near the product!
- Stay calm if fire breaks out. Search for the nearest exit. Do not return to the gazebo before firemen allow you to do so.

- Do not hang heavy weights on the roof frame.
- Do not climb onto the roof of the gazebo. Falling off the gazebo can result in serious injury.
- Retain the original packaging to store the gazebo.

IMPORTANT:

- Please read and understand this manual before any assembly. Before beginning assembly of product, make sure all parts are present. Compare parts with packaging contents list.
- If any part is missing, or if you have any questions, contact the service Centre at 888-328-5111.
- Place all parts from the box in a cleared area and position them on the floor in front of you.
- Remove all packing materials and place them back into the box. Do not dispose of the packing materials until assembly is complete.
- Read each step carefully before beginning any assembly and make sure you understand each step.
- Needed for assembly: (The following tools are not included)

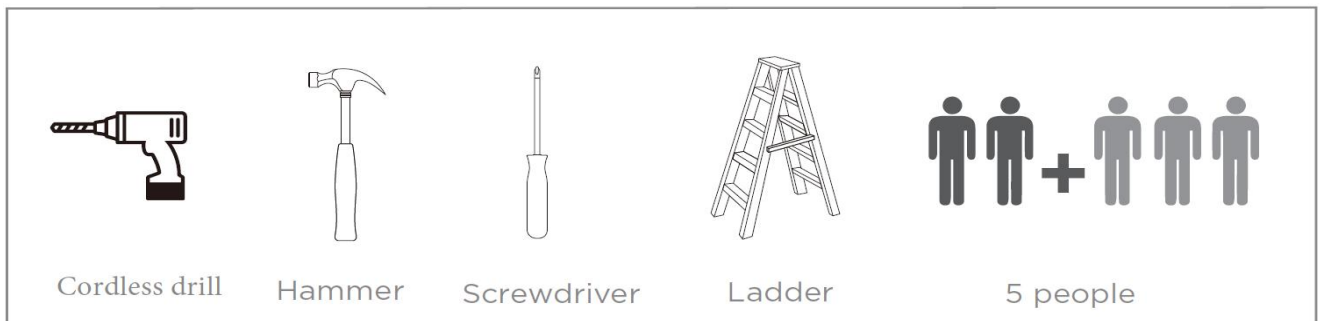

This identifies information that requires special attention. Improper assembly could lead to an unsafe or dangerous condition.



Use Level

Check that set or assembly is properly level before proceeding.

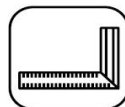

Square Assembly

Check that assembly is square before tightening bolts.

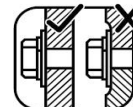











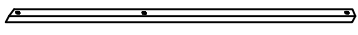

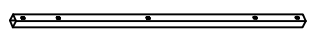

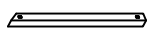

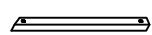













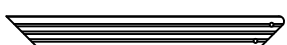

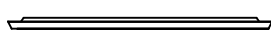

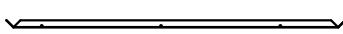
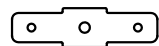
Tighten Bolts

Do not overtorque mounting bolts. Over-tightening may cause the wood to crack creating splinters and other structural damage.

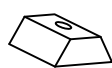

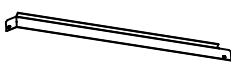

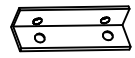















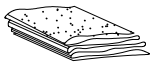

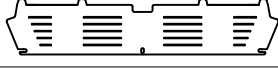

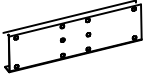



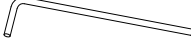

Measure Distance

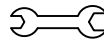
MOA016-6

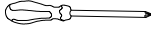

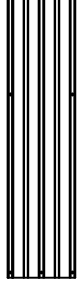

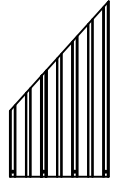
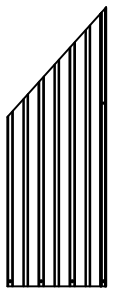
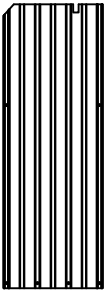
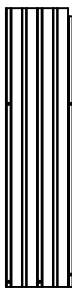

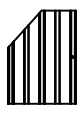

A		4	H1		4
A1		2	H2		8
B		2	H3		4
B1		2	H4		4
B2		2	J1		4
C		2	J2		6
C1		2	K		1
D		8	K1		1
E		4	L		4
E1		4	L1		2
F		4	M		8
F1		4	M1		6
G		8	M2		4
G5		2	M3		16
G6		2	M4		8
G7		2	M5		140
G8		2	M6		6
G9		2	M7		2
G10		2	M8		8
H		4	M9		8

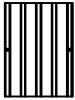
MOA016-6

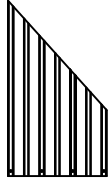
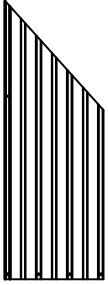
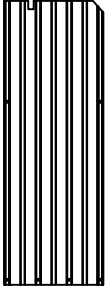
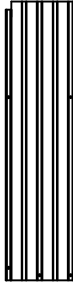
M10		4	X4	 5*10	16
M11		4	X5	 M6*50	40
R		68	X7	 M6*25	5
R1		16	X8	 M5*15	32
S		2	X9	 M6*10	32
S1		2	Z1		1
W		4	Z2		2
W1		4	Z3		2
P		6	Z4		2
Q		52	Z5		4
X	 M6*15	280			12
X1	 M6*10	16			1
X2	 M6*25	100			1
X3	 M6*30	4			1

N		N1		N2		N3	
8		2		2		2	
N4		N5		N6		N7	
2		2		2		2	

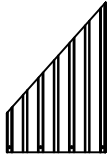
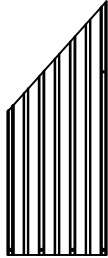
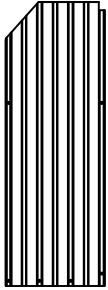
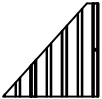
MOA016-6

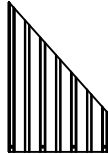
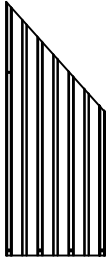
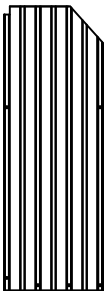
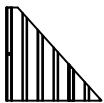
N8		Y1		Y2		Y3	
12		2		2		2	
Y4		Y5		Y6		Y7	
2		2		2		2	
O1		O2		O3		O4	
2		2		2		2	
O5		V1		V2		V3	
2		2		2		2	
V4		V5					
2		2					

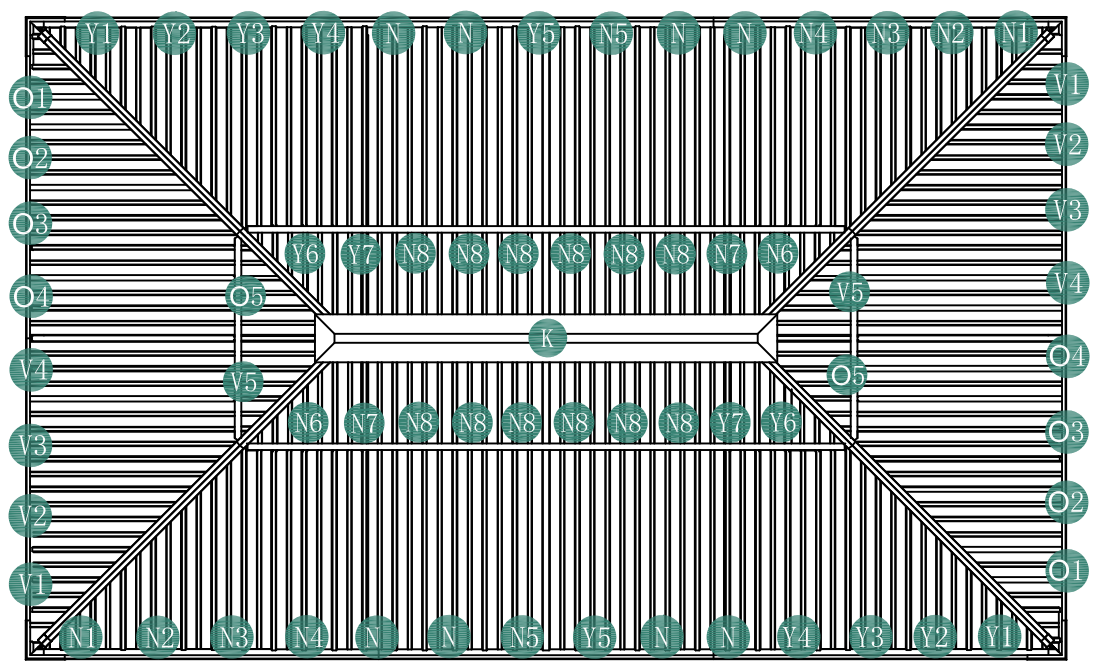
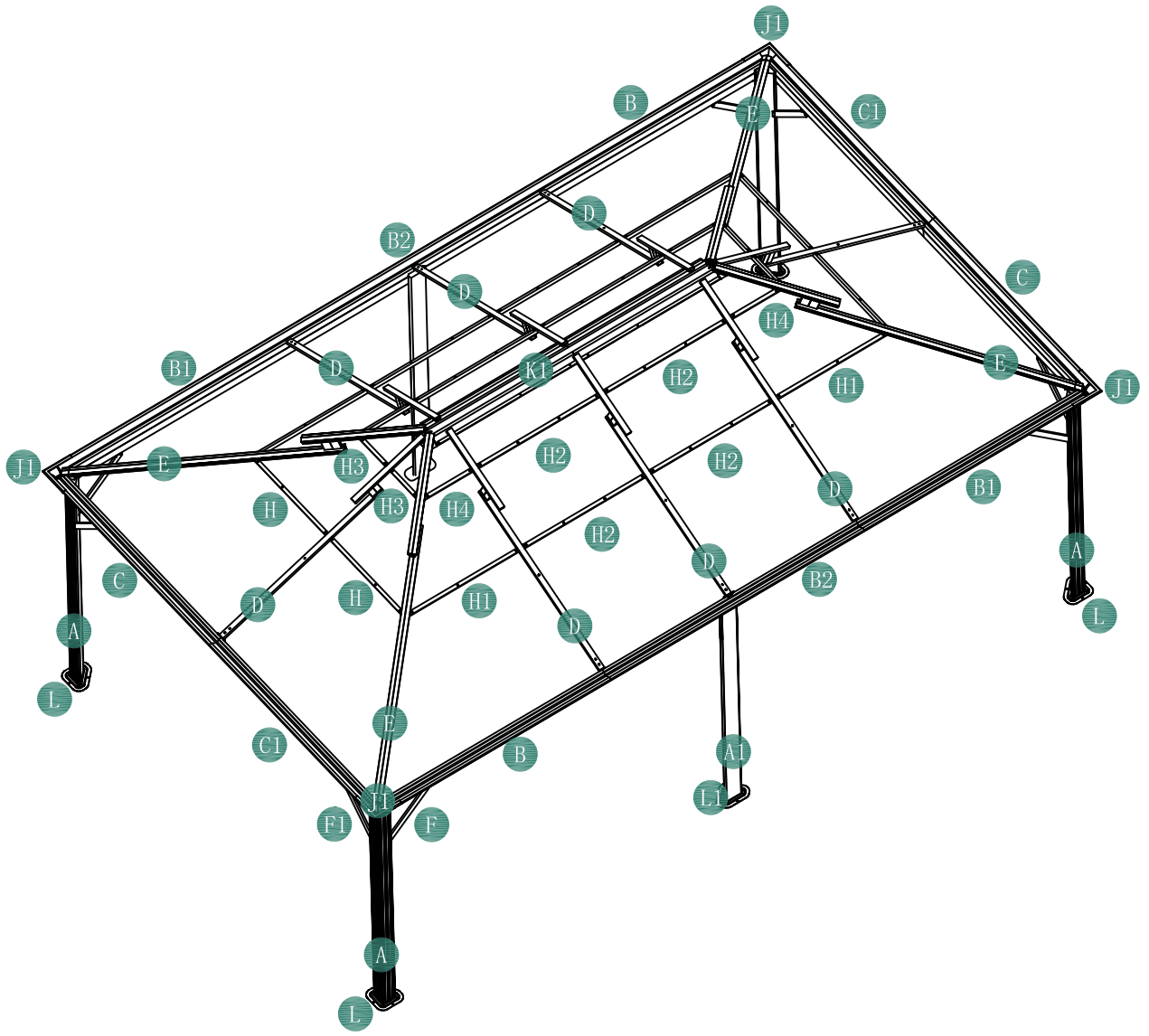

step1

Connect Stake Plate(L/L1) to bottom of Post(A/A1) by using Bolt (X)

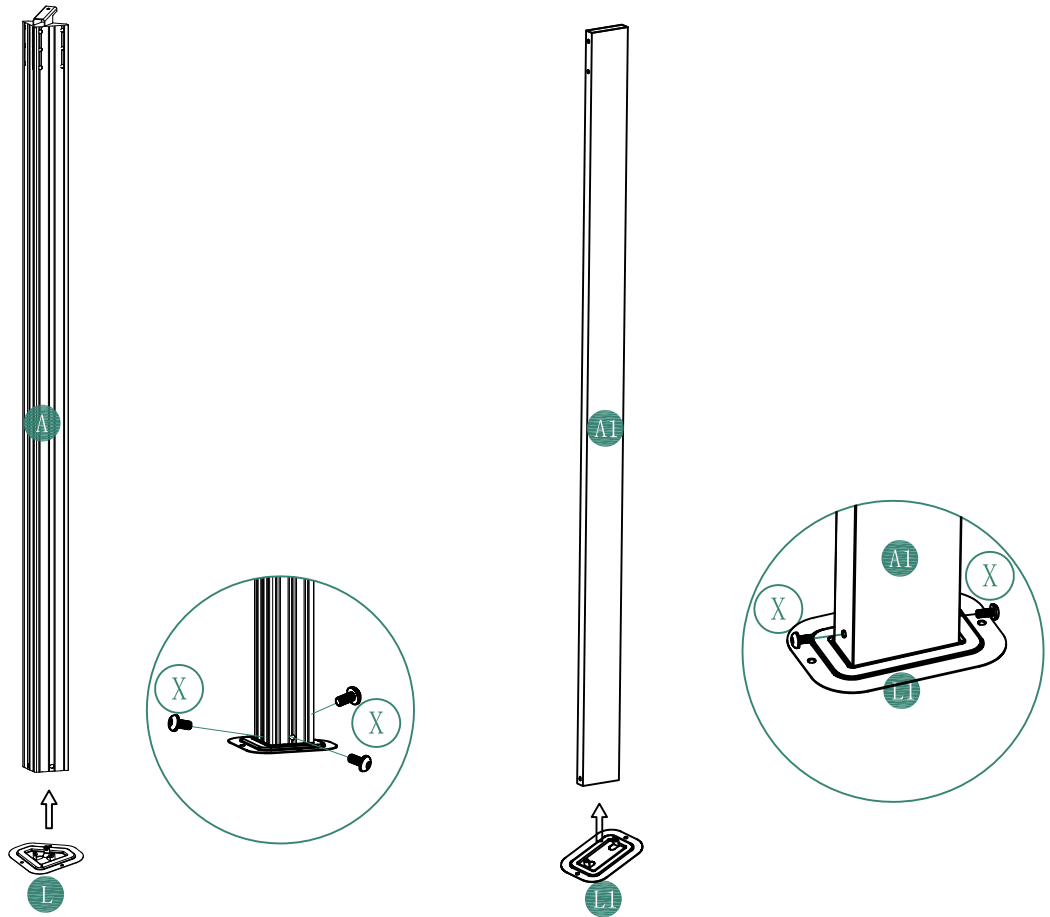

step2

1-Attach Long Side Beam (B1) and Short Side Beam (C) to Post A), fix by using Bolt (X1).
2-Attach assembled Long Side Beam (B1) & assembled Long Side Beam (C) to Beam Connector(M8), fix by using Bolt (X/X8).
3-Attach assembled Post(A1) & Long Side Beam (B2) to Beam Connector(M11) , fix by using Bolt (X)

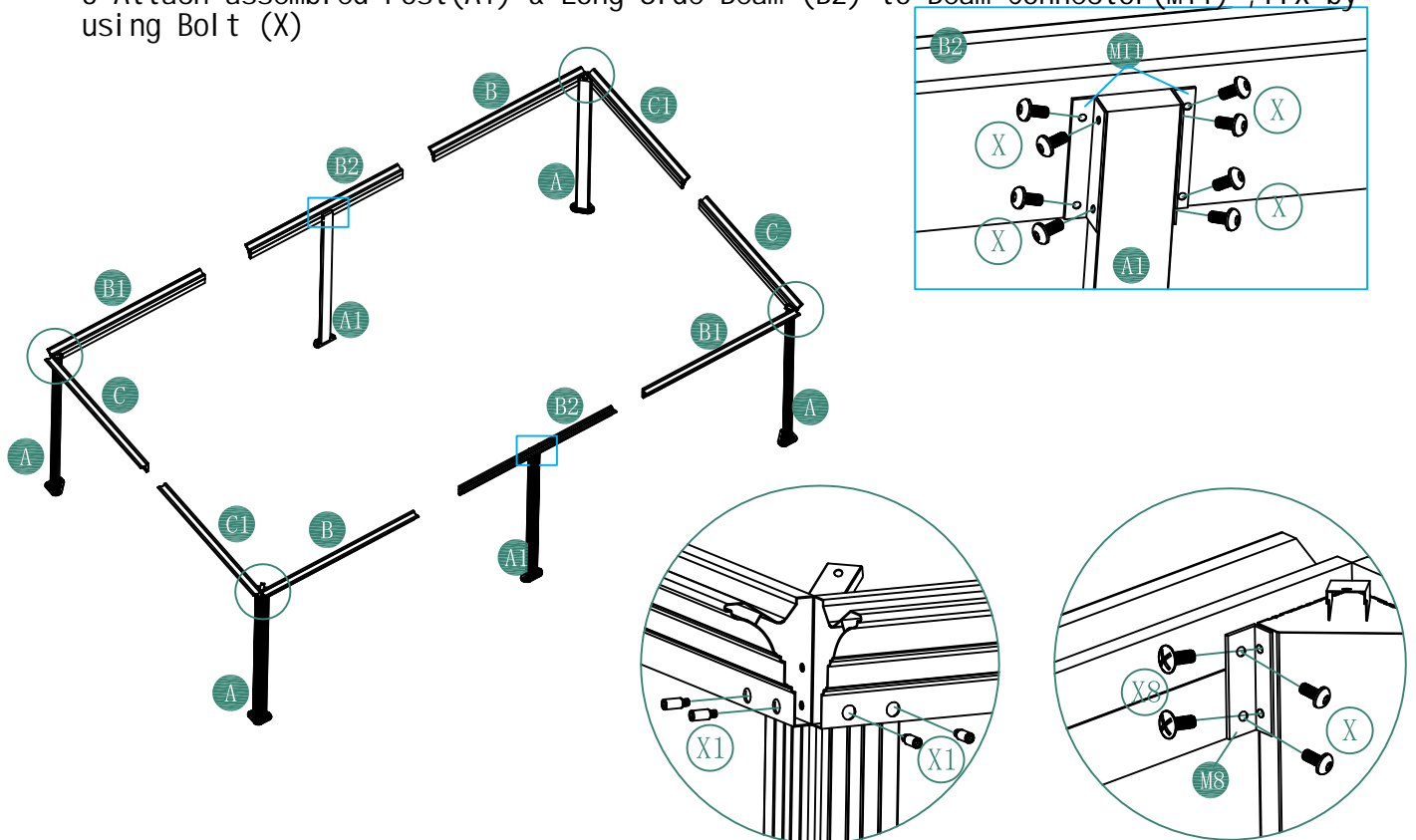

step3

Attach assembled Long Side Left Beam (B1) & assembled Long Side Right Beam (B2) to Beam Connector (P), fix by using Bolt (X).

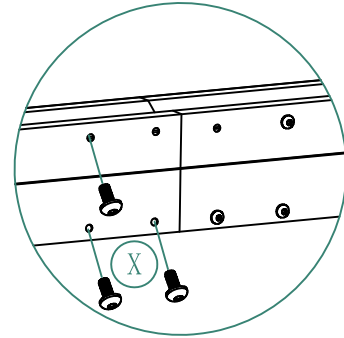
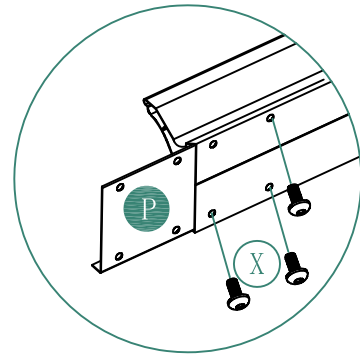
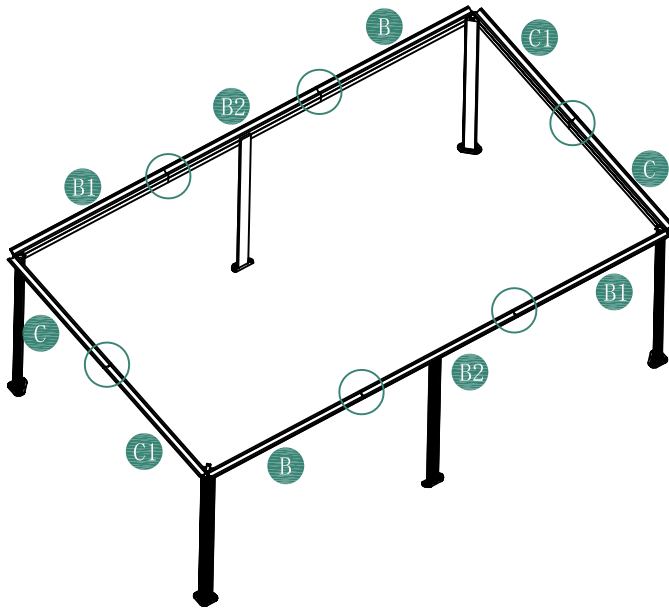

step4

1-Attach part M to inside Post(A) by using Bolt(X8)
2-Attach Top of Left/Right Slant Support (F/F1) to Assembled beam (B/B1/C/C1) and attached the bottom of Left/Right Slant Support (F/F1) to Post(A), fasten by using Bolt (X9).

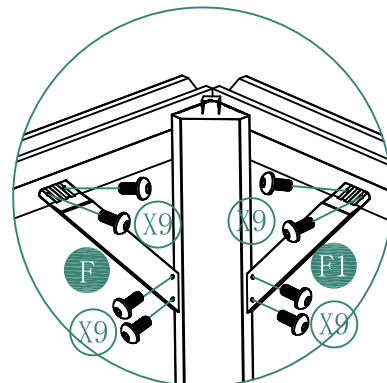
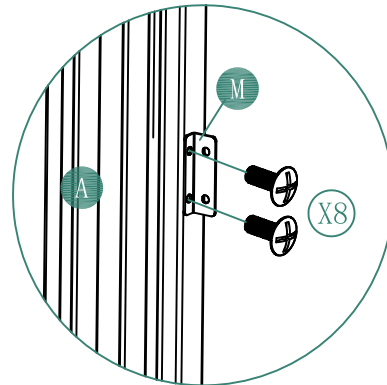
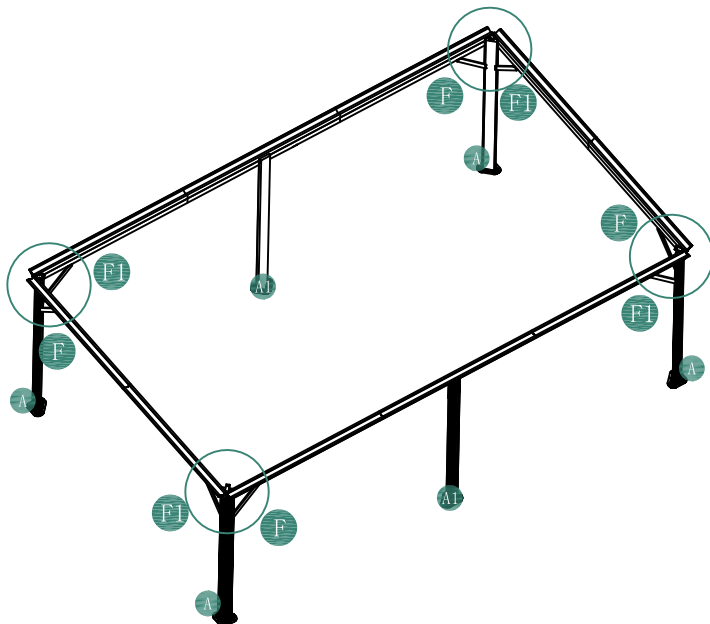

step5

Attach part (W/W1) to inside beams(B/B1/B2/C/C1)fix by using Bolt(X)

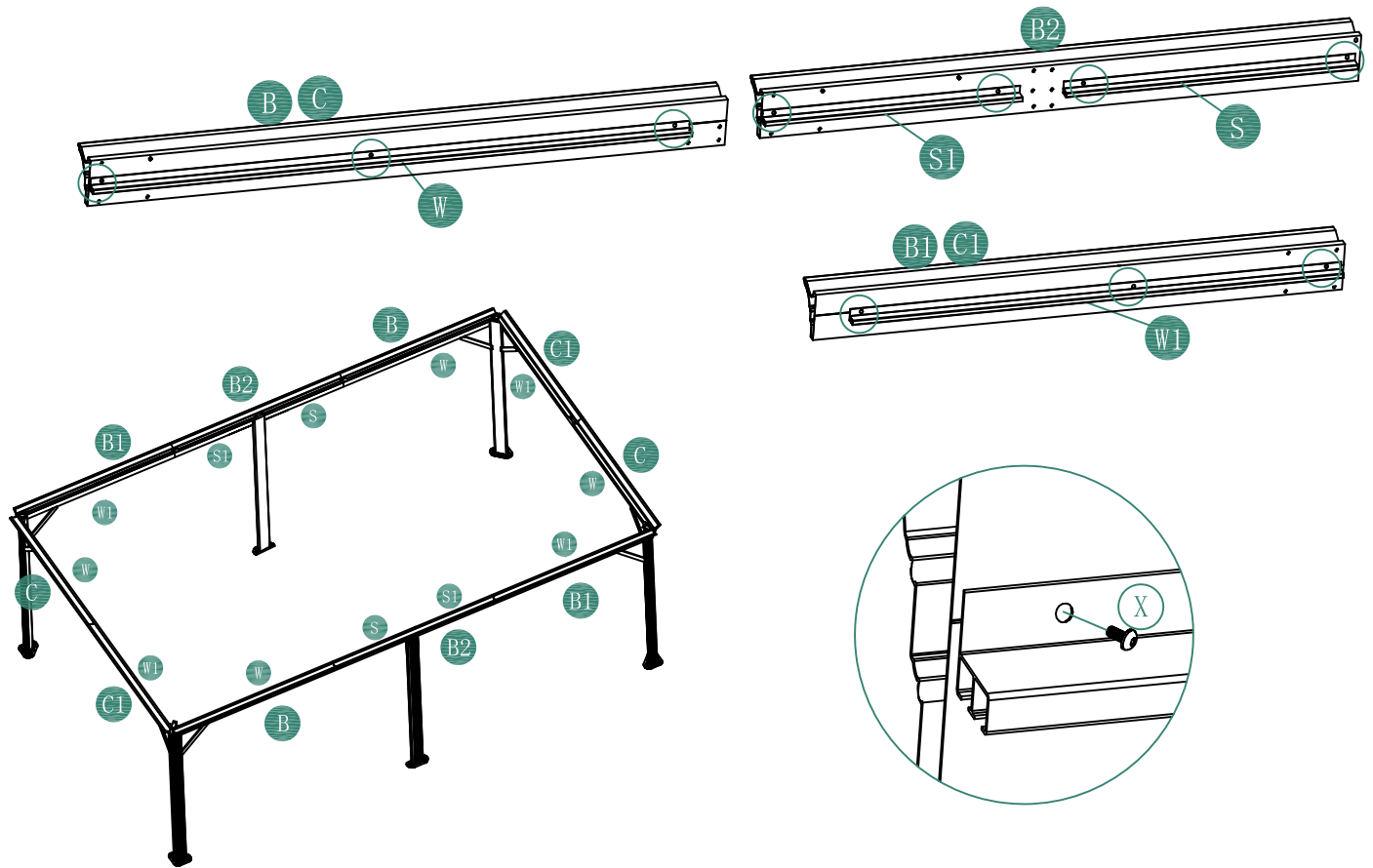

step6

Attach part M9 to inside beams(B/B1/B2/C/C1)fix by using Bolt(X)

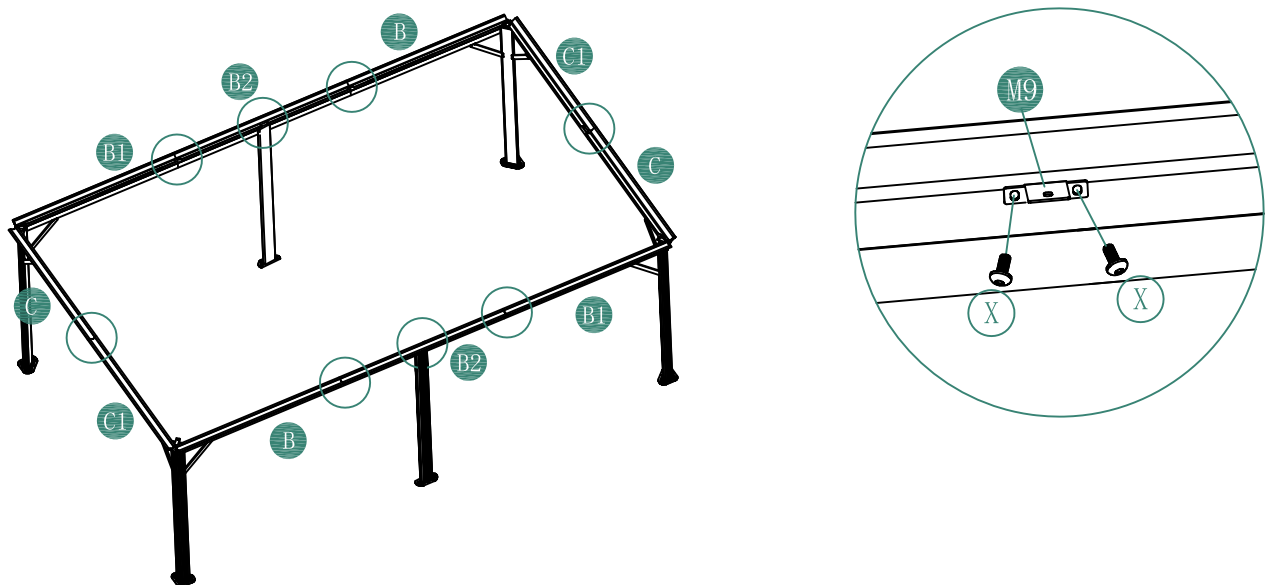

step7

- 1-Attach short roof ribs (D) to inside part (M9) fix by using Bolt(X)
- 2-Attach the top of short roof ribs (D) to the Roof Top Brace(K)fix by using Bolt (X)

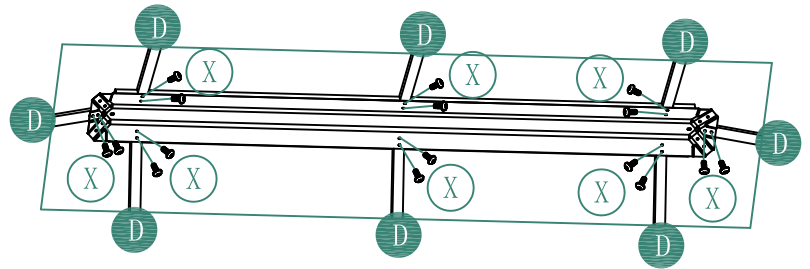
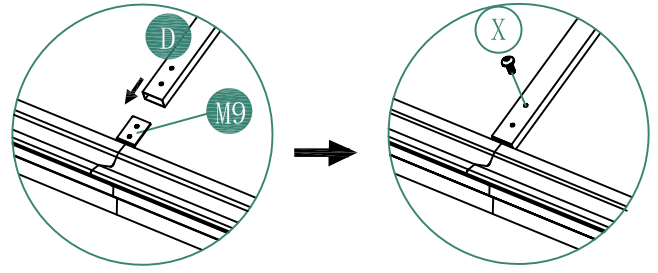
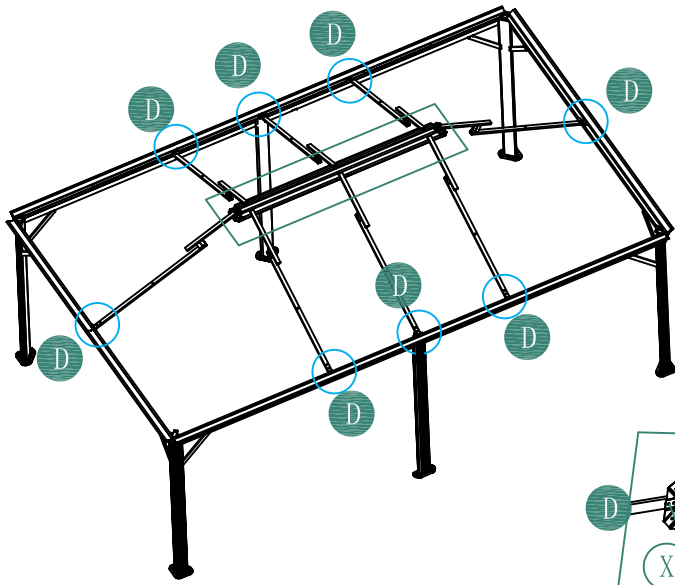

step8

Attach the long roof ribs (E) to the short roof(E1) by using Bolt (X) and Part M10

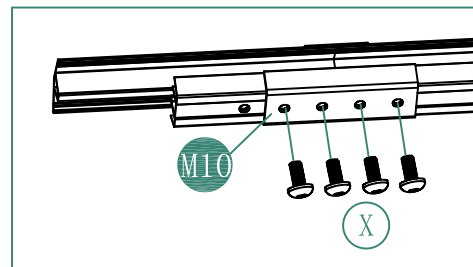
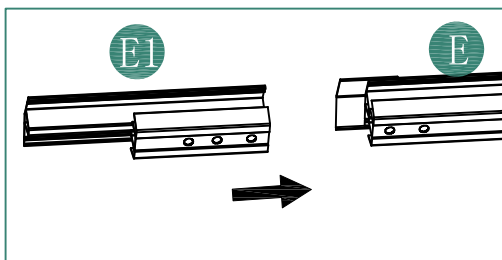
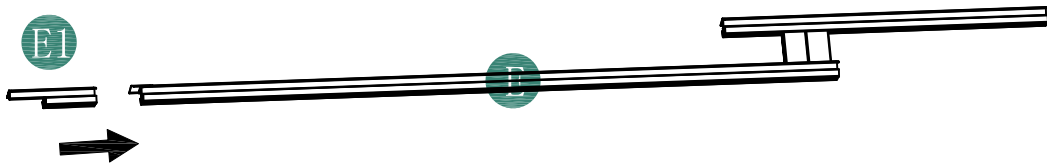

step9

Attach the long roof ribs (E) to the Post (A) by using Bolt (X)

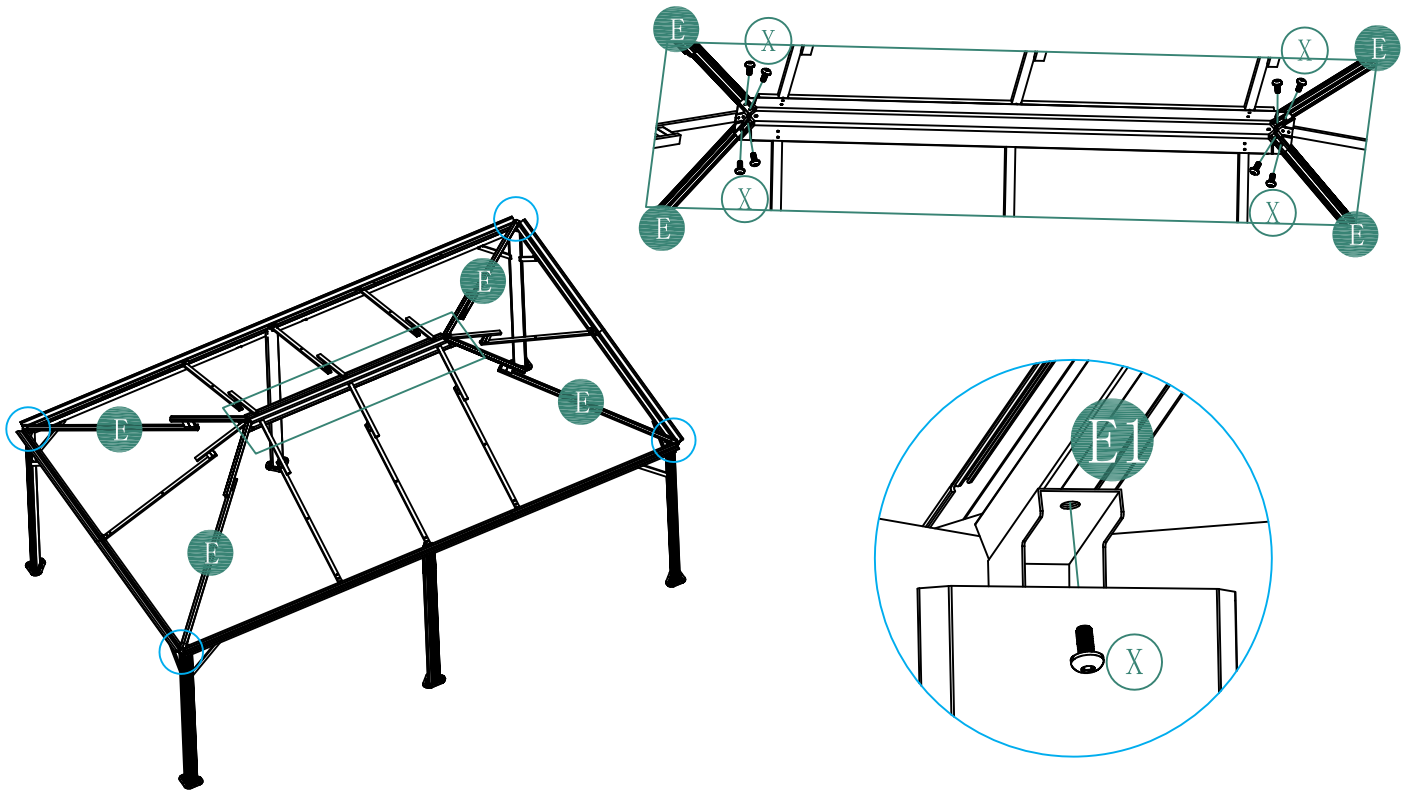

step10

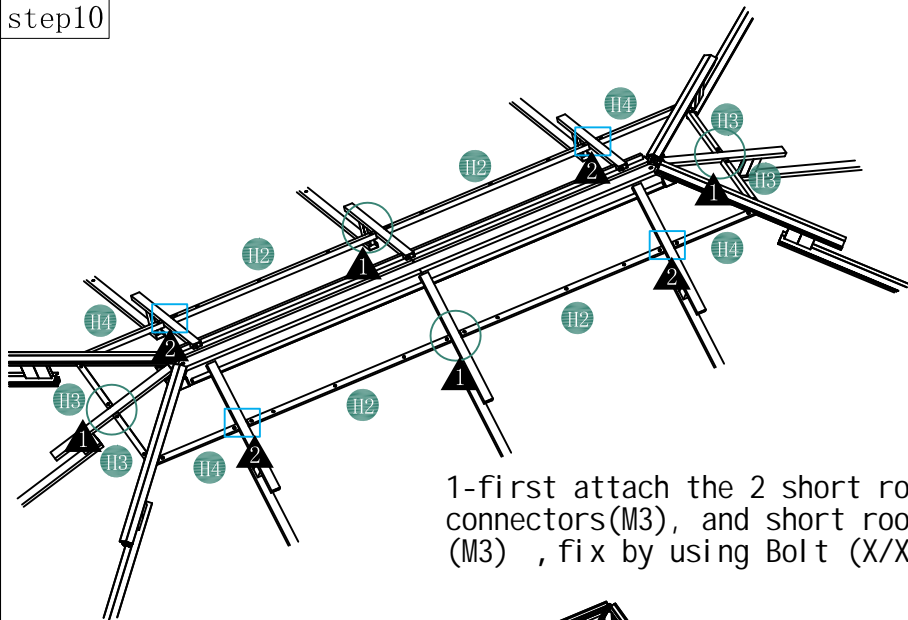

1-first attach the 2 short roof supports(H3) to connectors(M3), and short roof supports (D) to connectors (M3) , fix by using Bolt (X/X5)

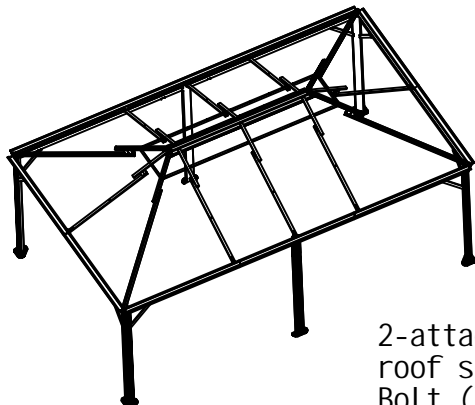

2-attach assembled long roof supports(H2) and short roof supports (H4) to connectors (M3) , fix by using Bolt (X) ; then short roof supports (D) to connectors (M3) , fix by using Bolt (X)

step11

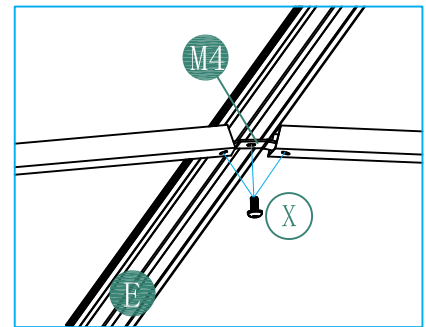
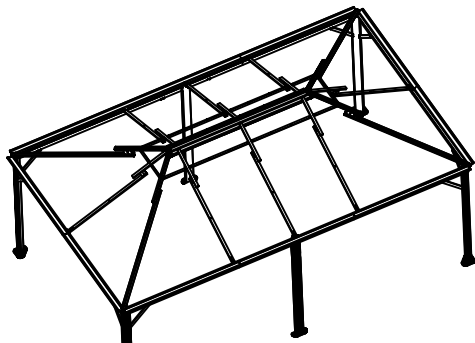
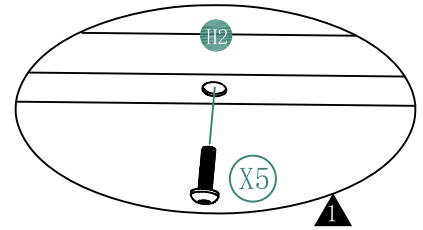
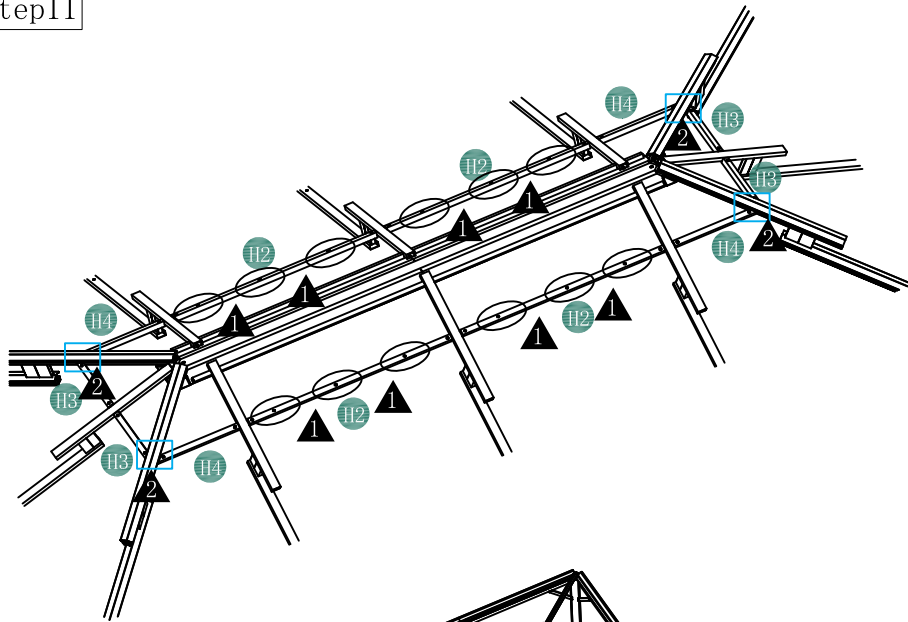

Attach assembled short roof supports(H3) and short roof supports (H4) to connectors (M4) , fix by using Bolt (X) ; then long roof supports (E) to connectors (M4) , fix by using Bolt (X)

step12

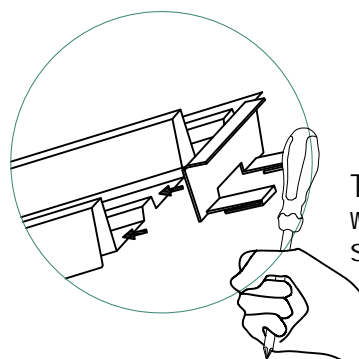
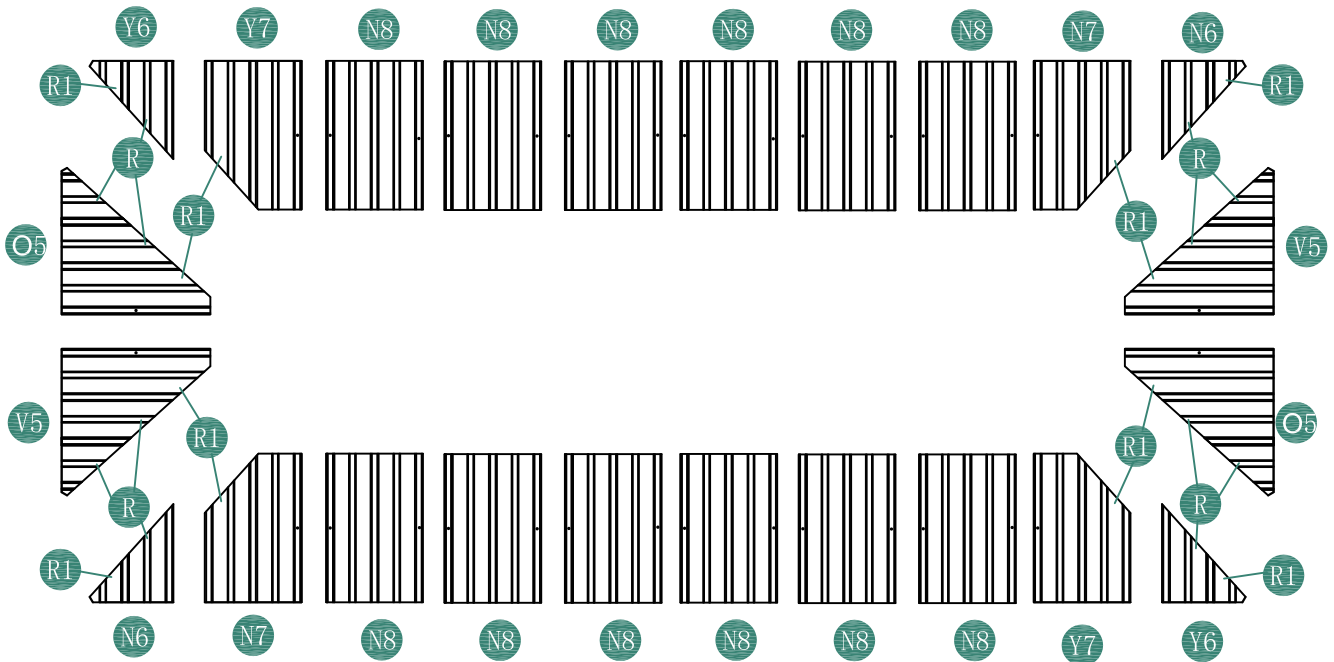

Tap lightly with the screwdriver

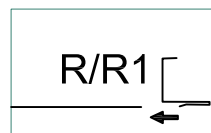

Attach the clips(R1) and clips(R) as shown in the diagram

step13

1-Install the Roof Plates (O5, V5, N6, N7, Y6, Y7) on the short Sides of the Gazebo. fix by using bolt (X5) Please note that when installing the screws (X5) again, you need to put on M5

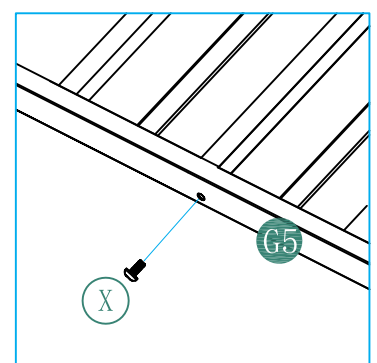
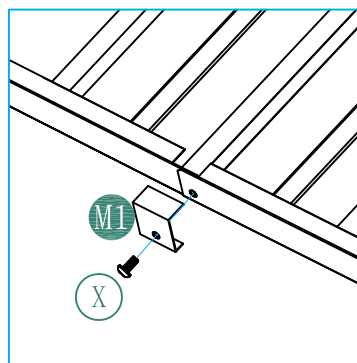
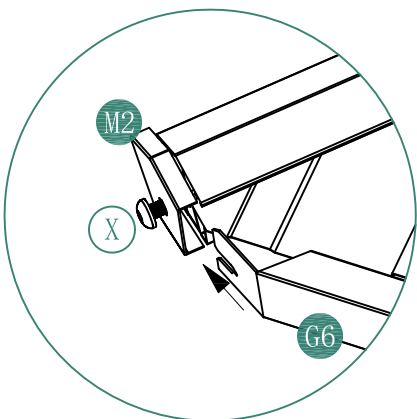
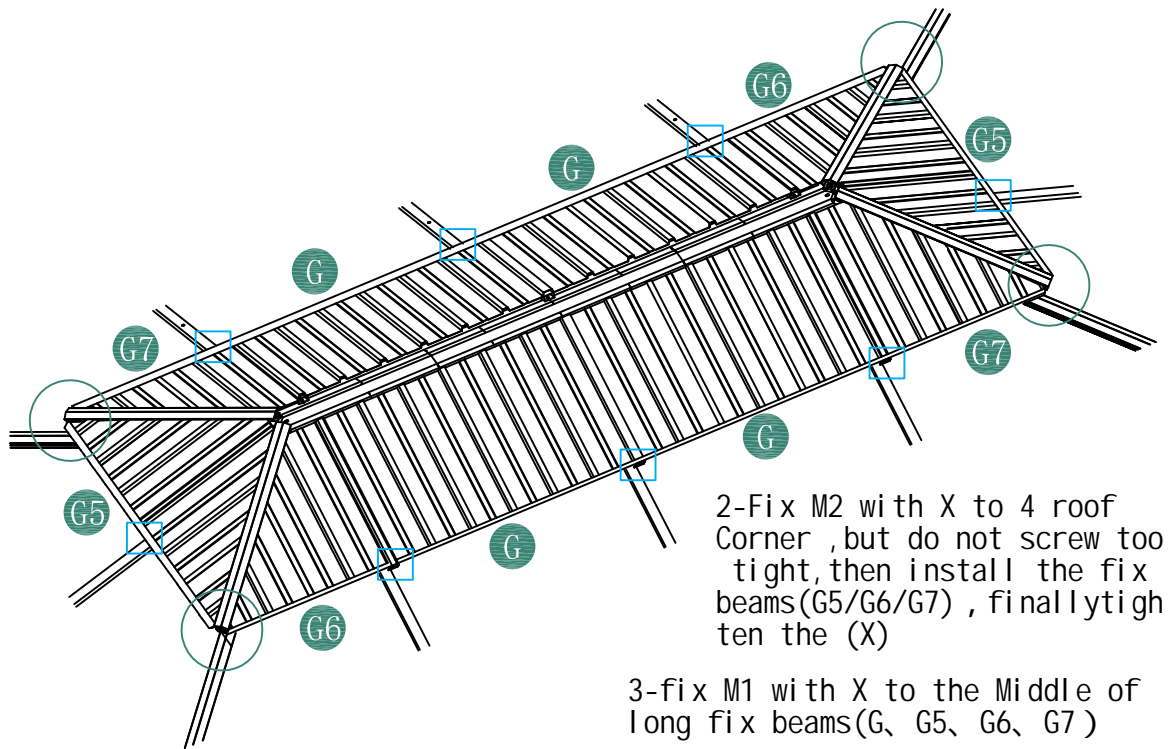
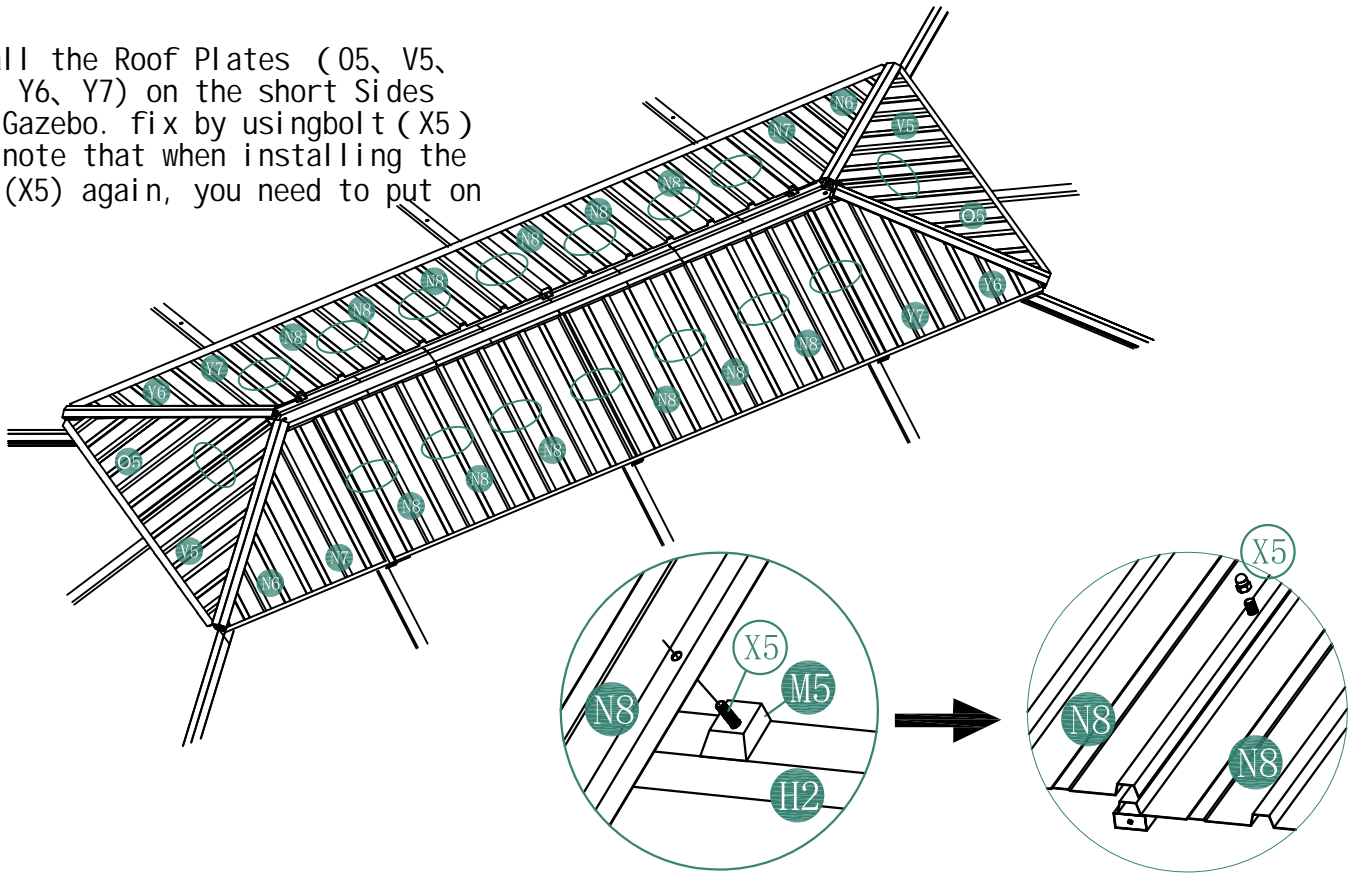

step14

Attach the 2 roof supports(K/K1) to connectors(M7) and fix by using Bolt (X7)

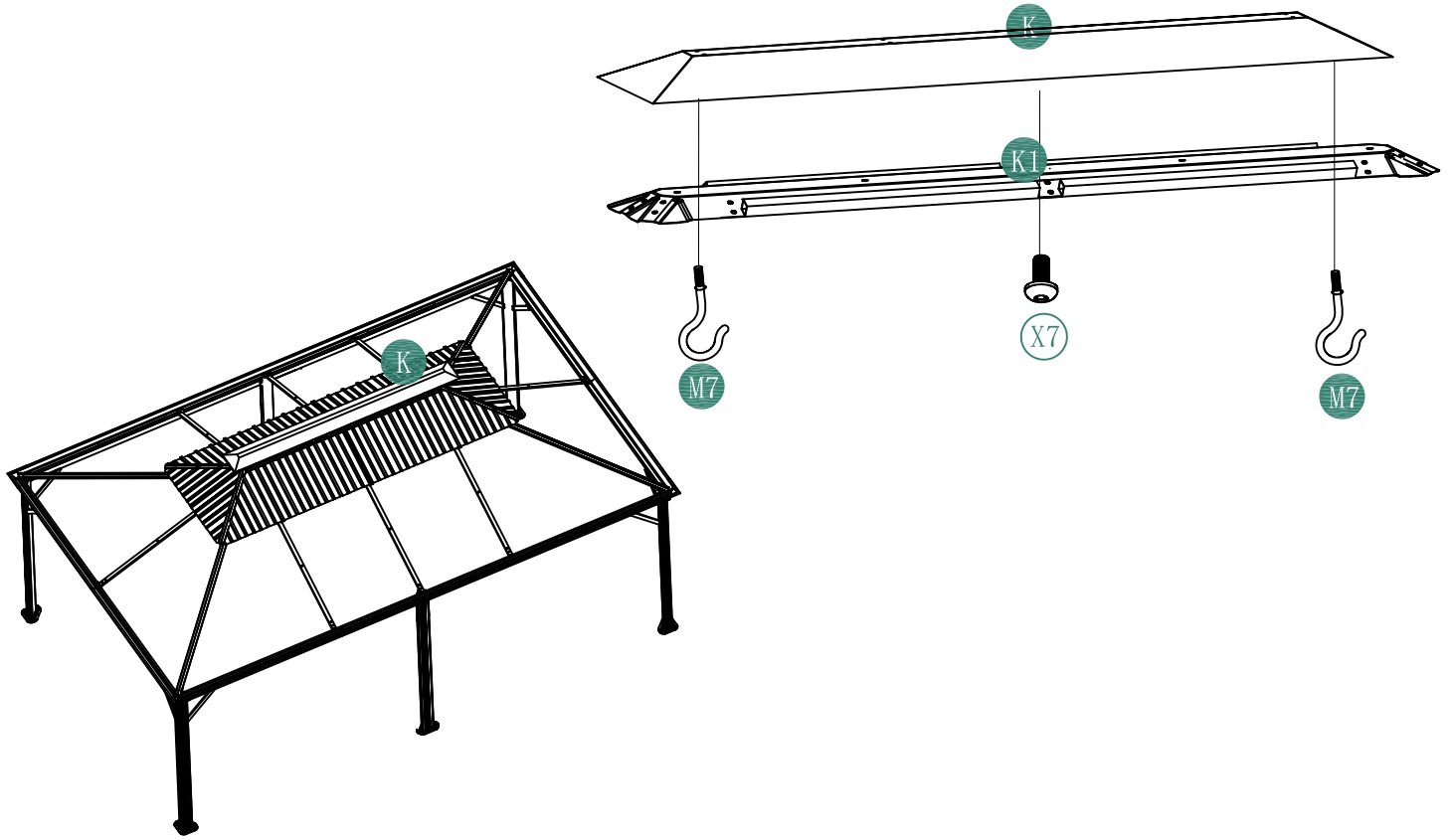

step15

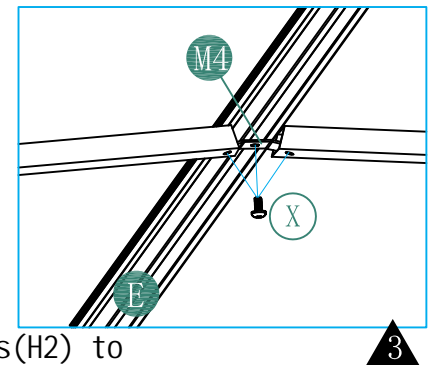
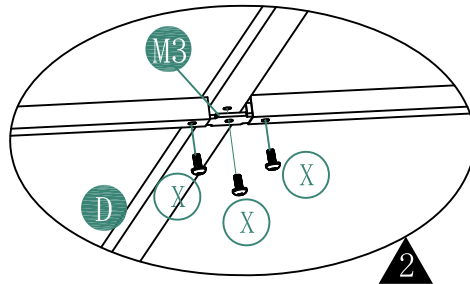
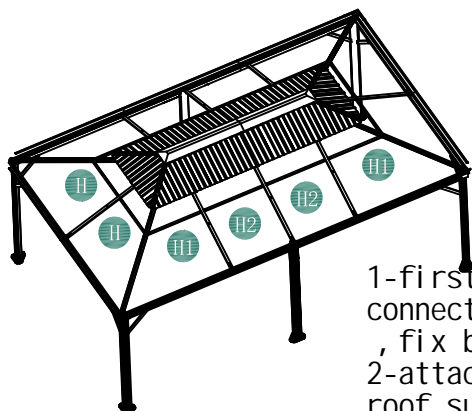
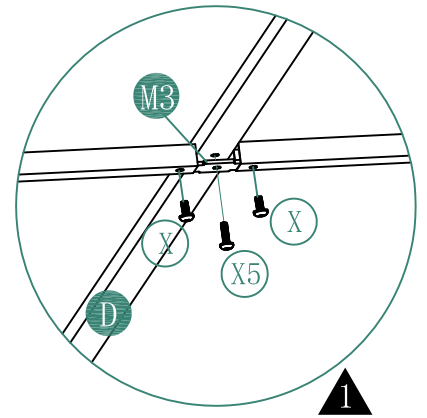
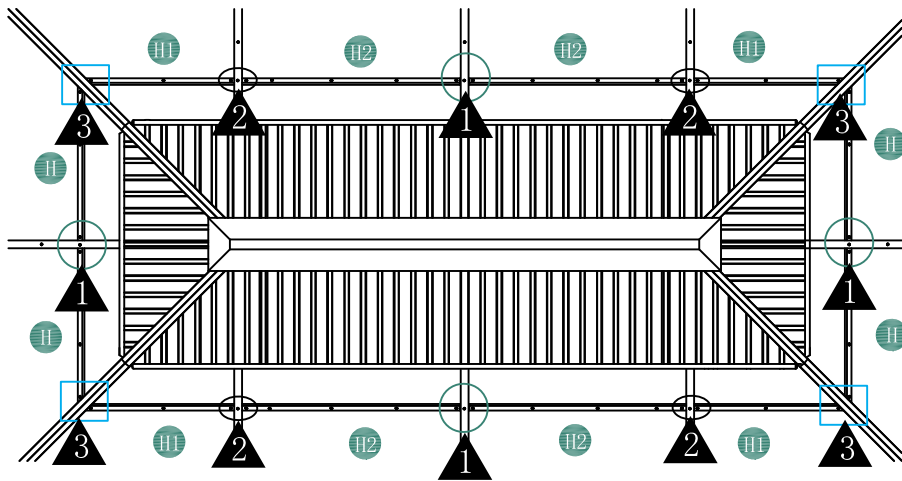

1-first attach the 2 short roof supports(H2) to connectors(M3), and short roof supports (D) to connectors (M3) , fix by using Bolt (X/X5)
2-attach assembled long roof supports(H) and short roof supports (H1) to connectors (M4) , fix by using Bolt (X) ; then short roof supports (E) to connectors(M4) , fix by using Bolt (X)

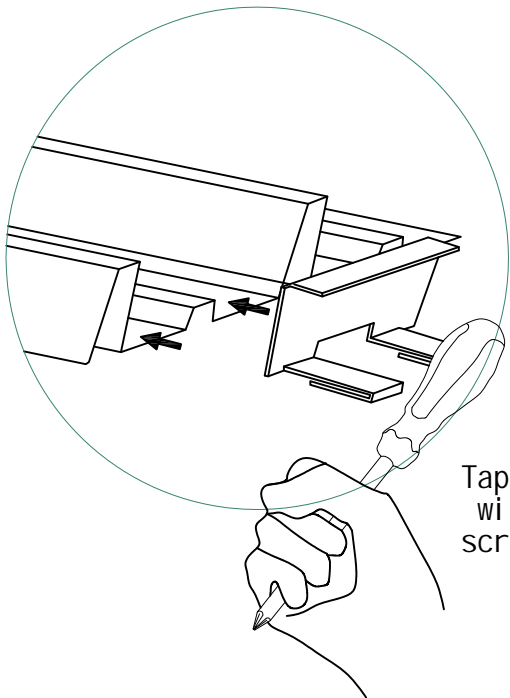
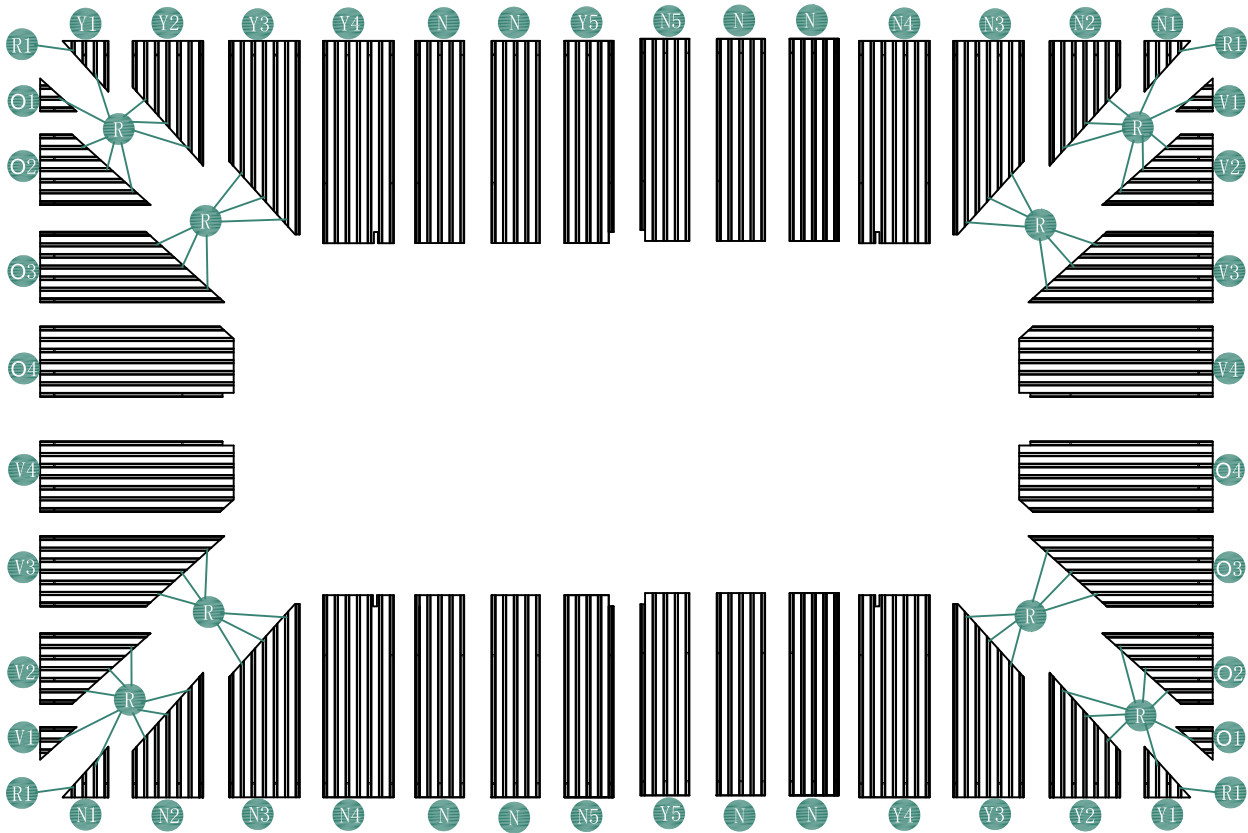

Tap lightly with the screwdriver

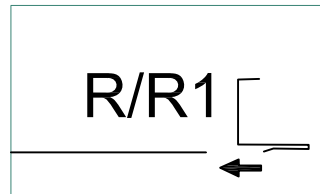

Attach the clips(R1) and clips(R) as shown in the diagram

step17

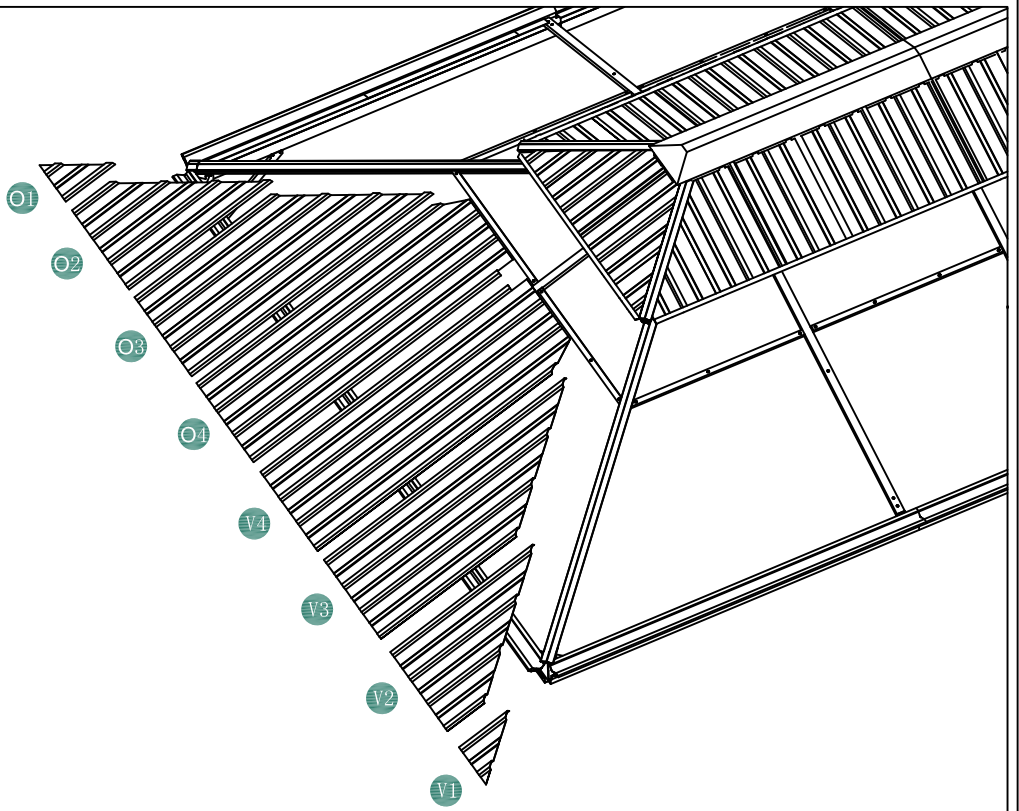
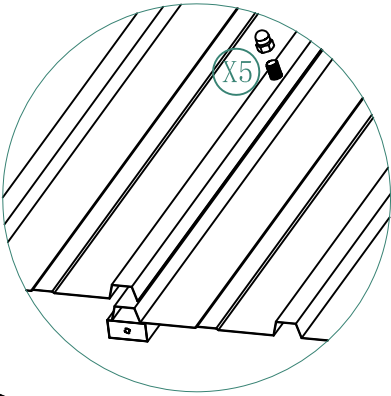
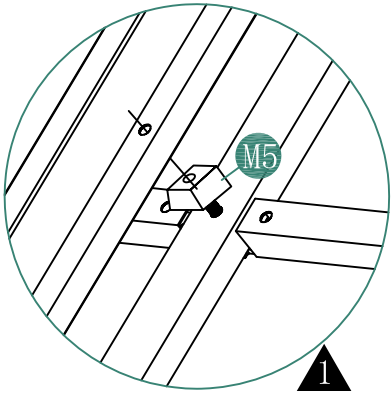

Install the Roof Plates (O1, O2, O3, O4, V1, V2, V3, V4) on the Long Sides of the Gazebo. fix by using bolt (X7, X5, X2)
Please note that when installing the screws (X5 and X2) again, you need to put on M5

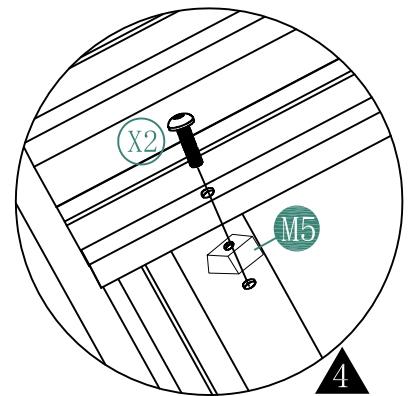
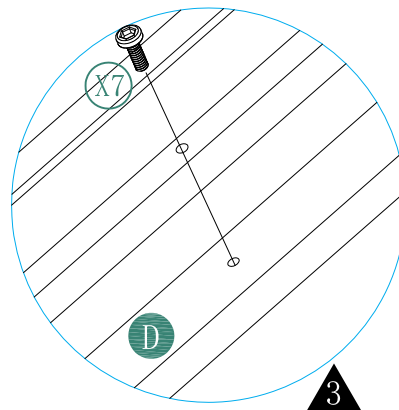
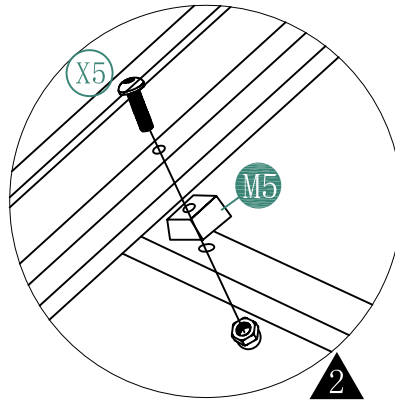
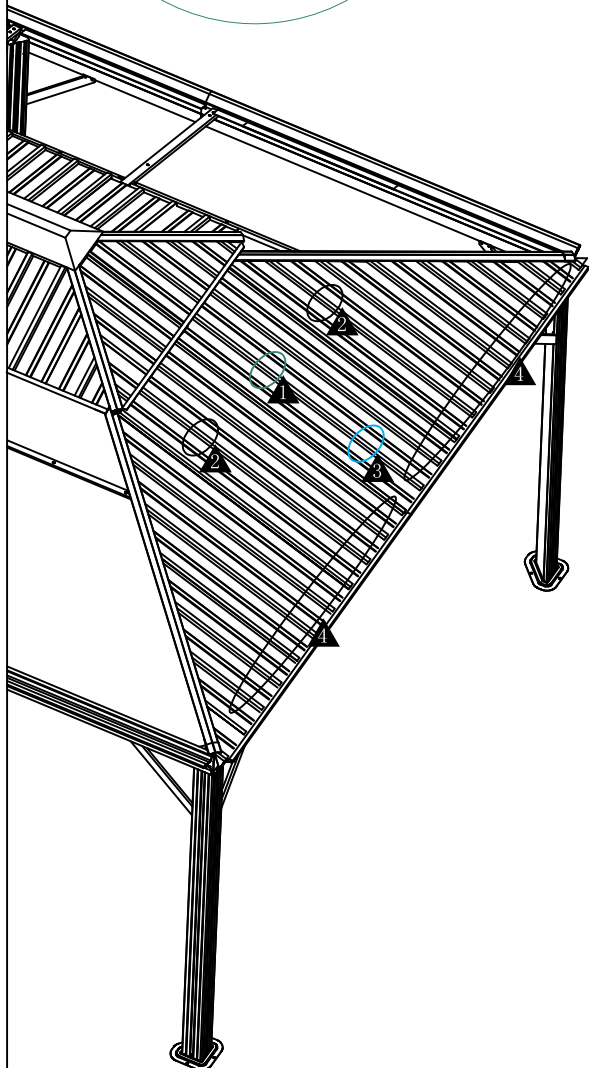

step18

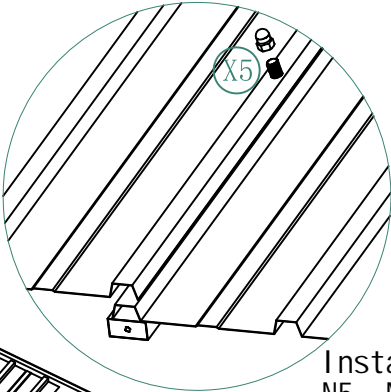
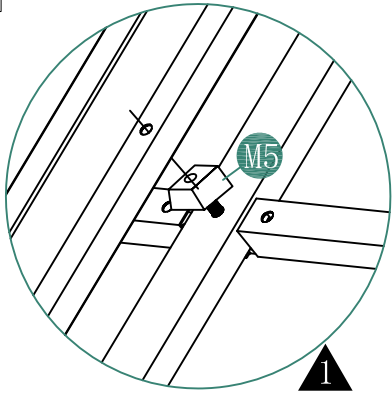

Install the Roof Plates (N1, N2, N3, N4, N5, N, Y1, Y2, Y3, Y4, Y5) on the Long Sides of the Gazebo. fix by using bolt (X7, X5, X2)
Please note that when installing the screws (X5 and X2) again, you need to put on M5

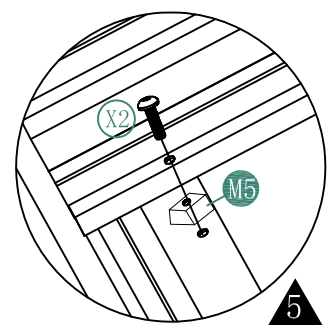
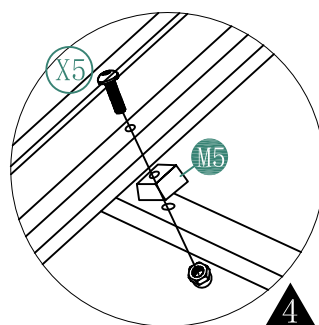
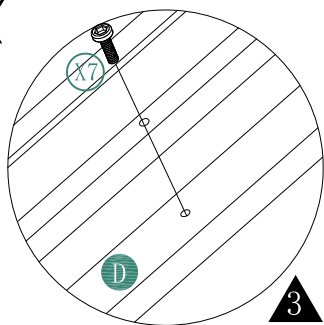
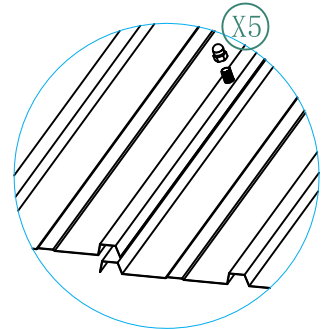
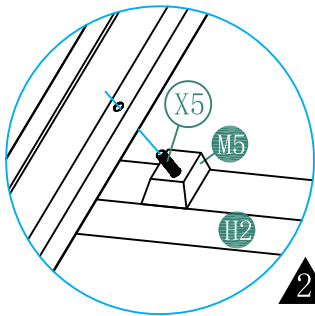
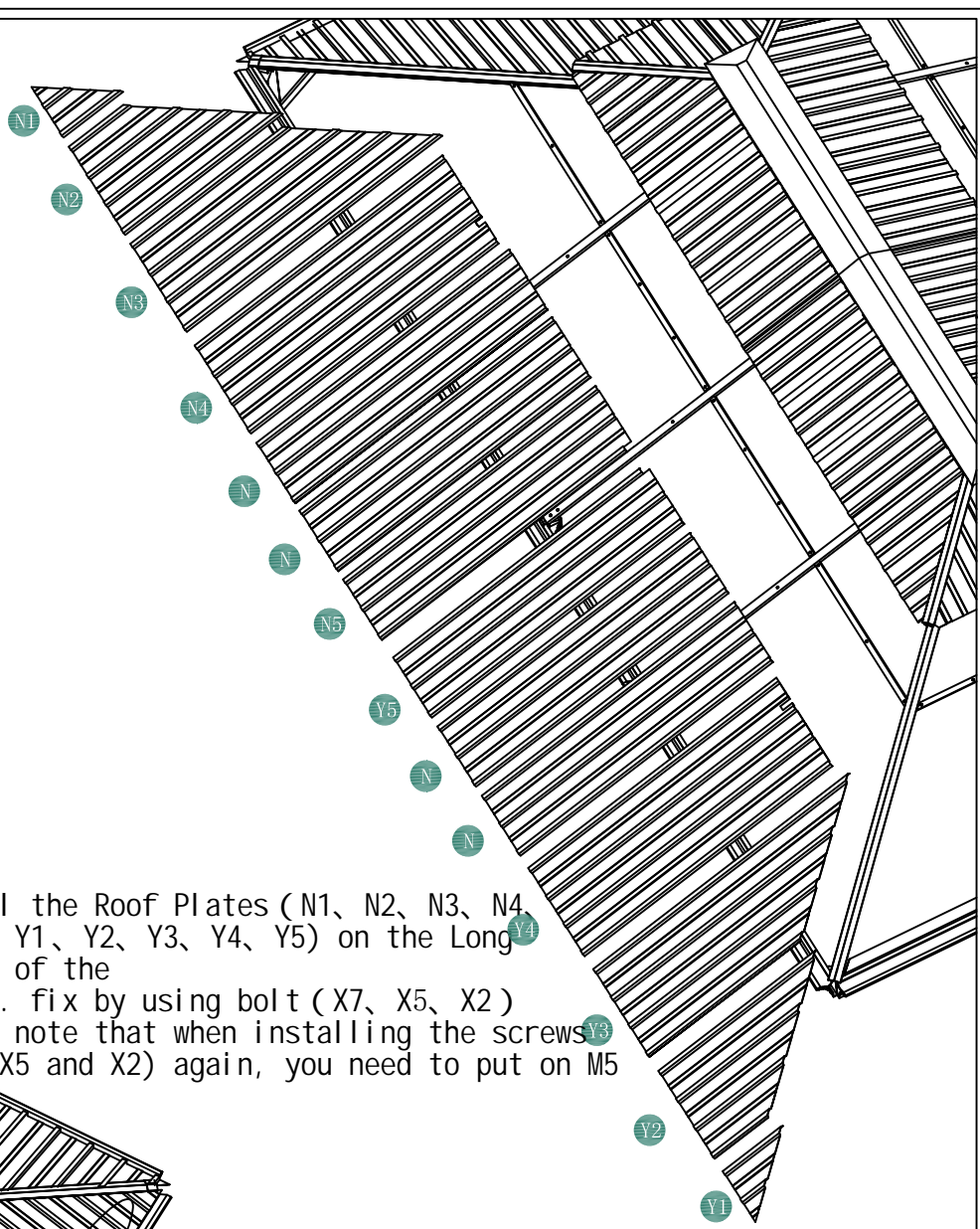

step19 Attach Corner Sleeve (J1) to assembled Beam(B/B1/C/C1),
fasten by using Bolt (X4).

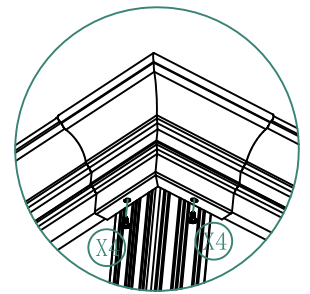
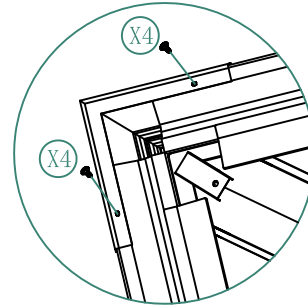
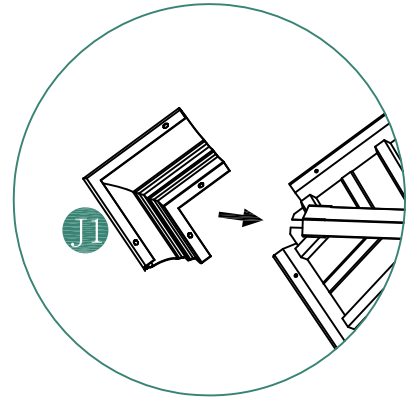
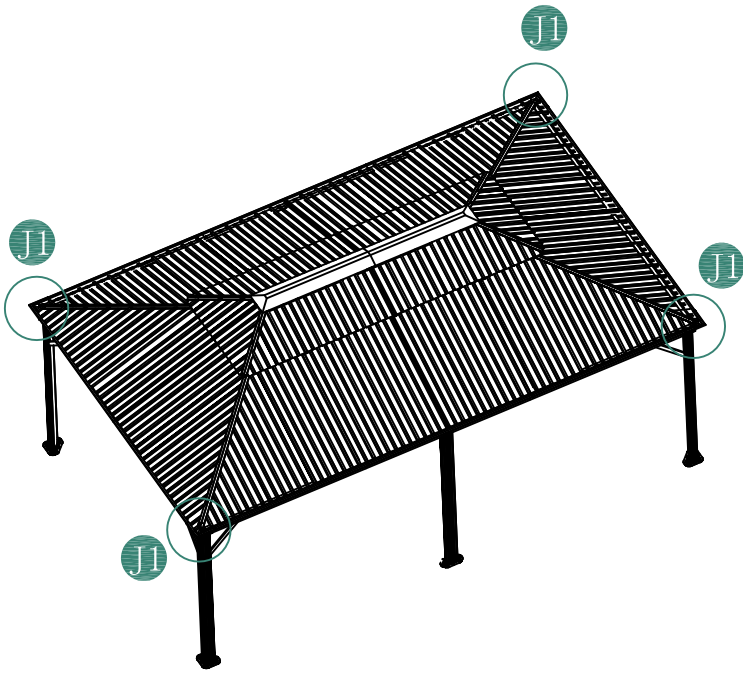

step20 1-Slide 5 Hooks(Q) into long sides beams(W/W1).
2-Slide 3 Hooks(Q) into long sides beams(S/S1).

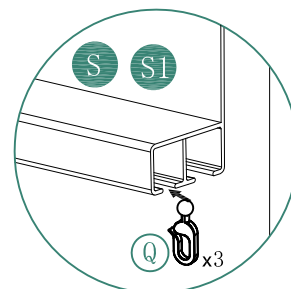
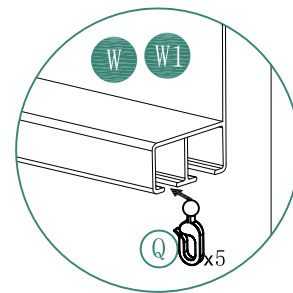
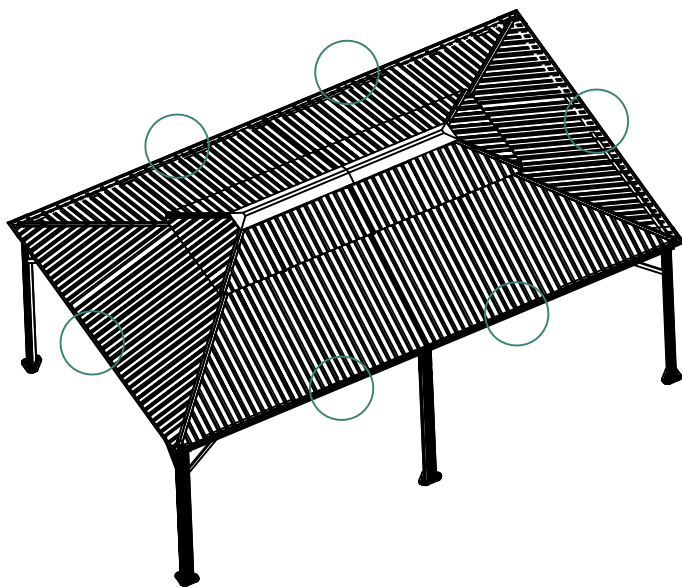

step21 Attach part J2 and M6 to inside beams(B/B1/B2/C/C1)fix by using Bolt(X)

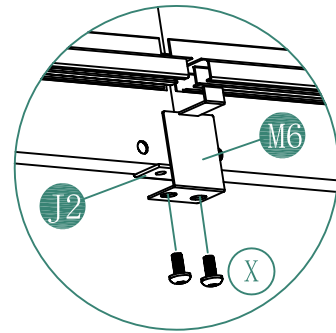
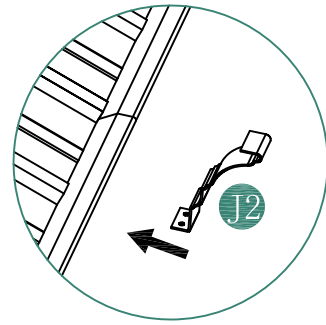
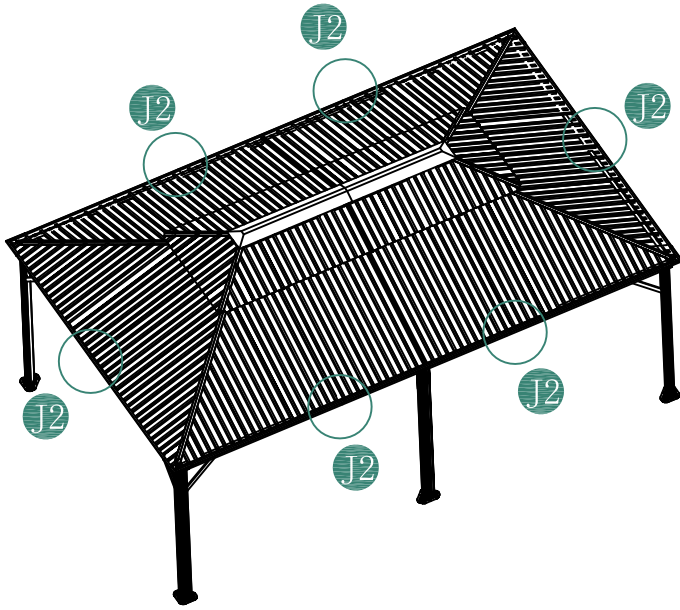

step22

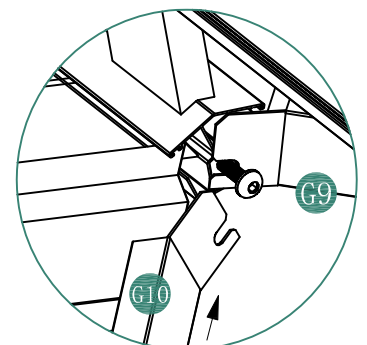
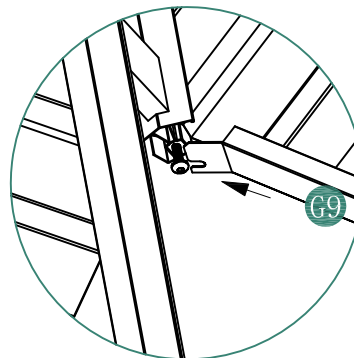
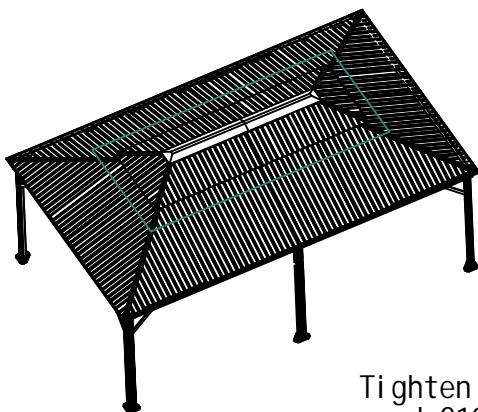
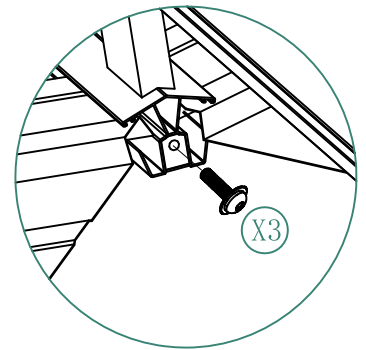
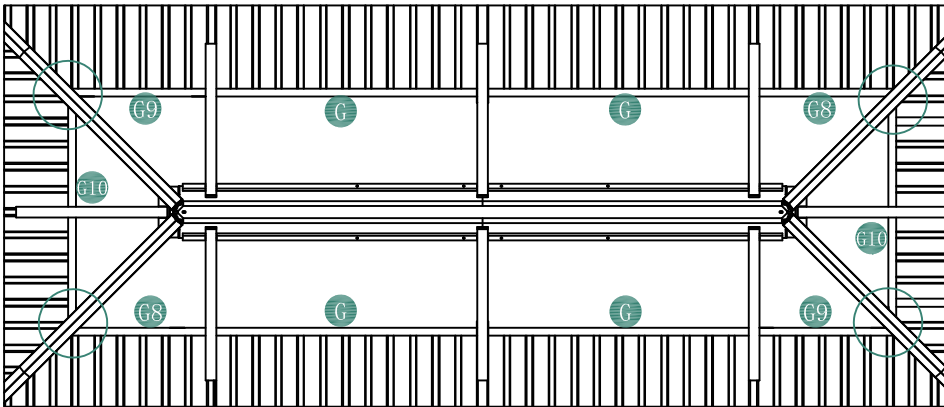

Tighten the screw (X3) halfwy , then install the fix beams (G9 and G10) , finally tighten the (X3)

step23

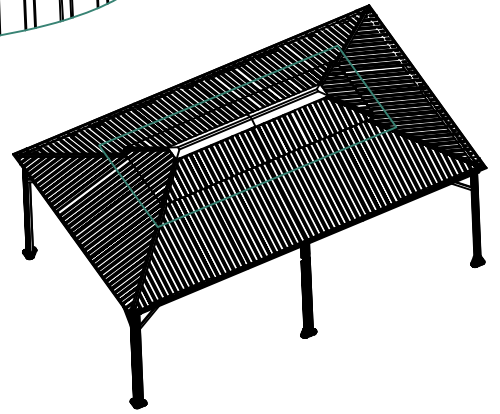
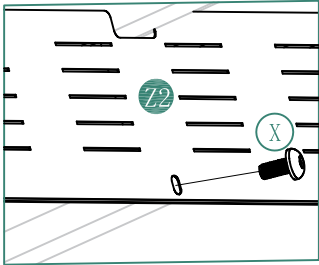
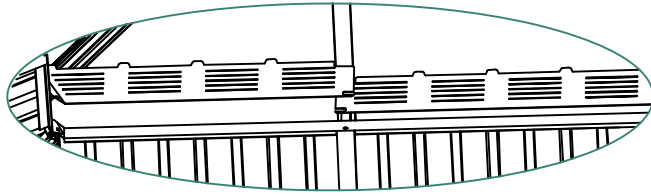
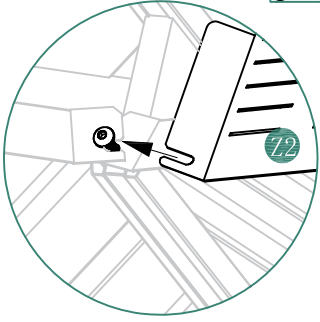
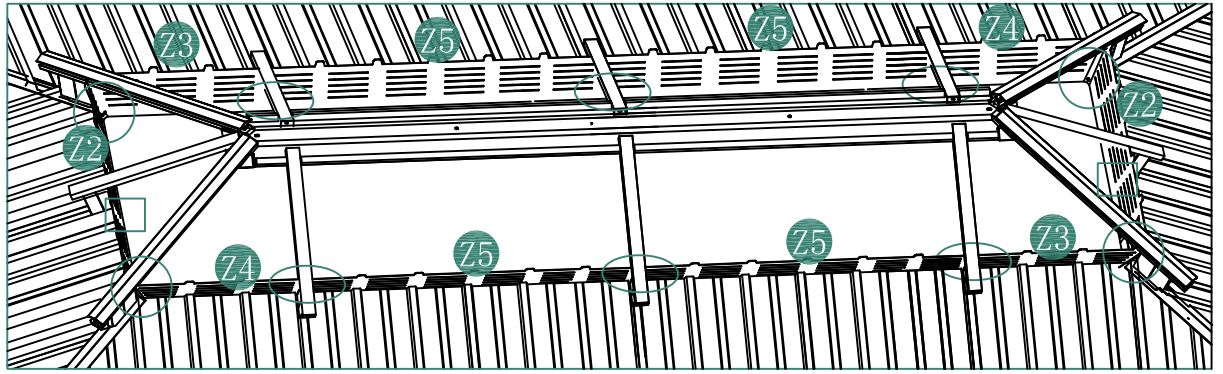

step24

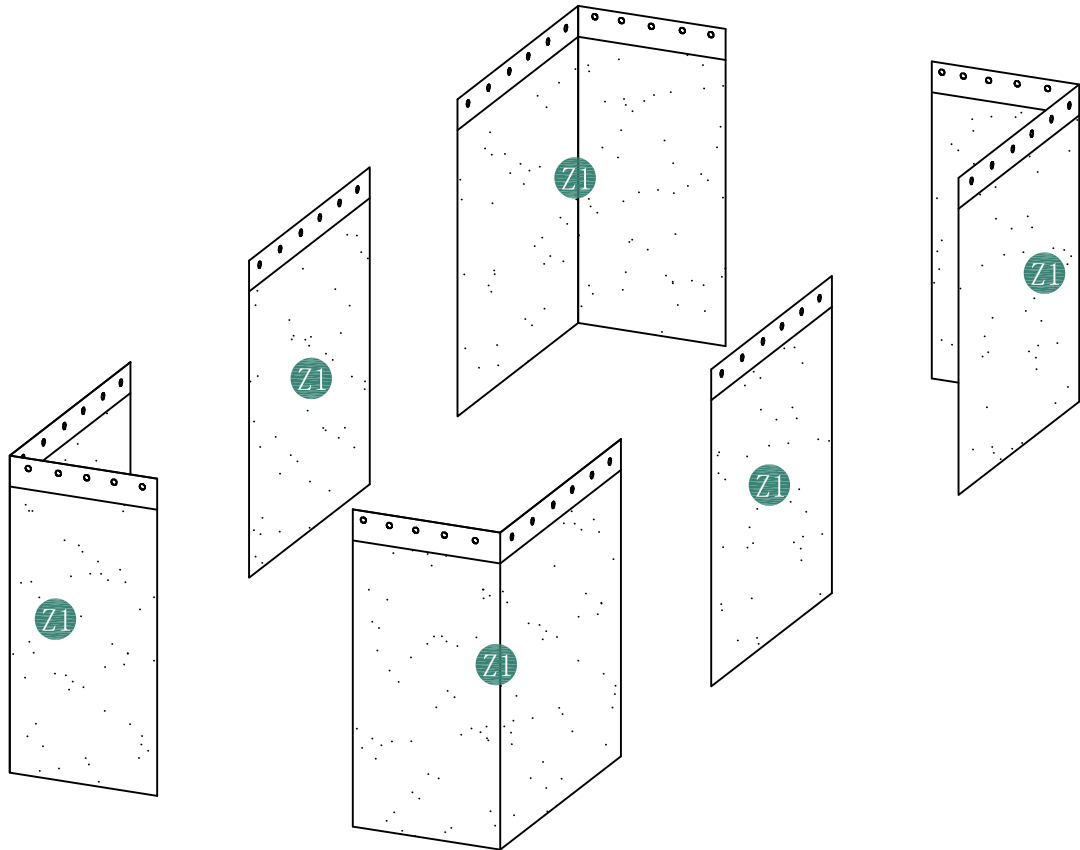

step25

Install the mosquito netting as shown in the diagram

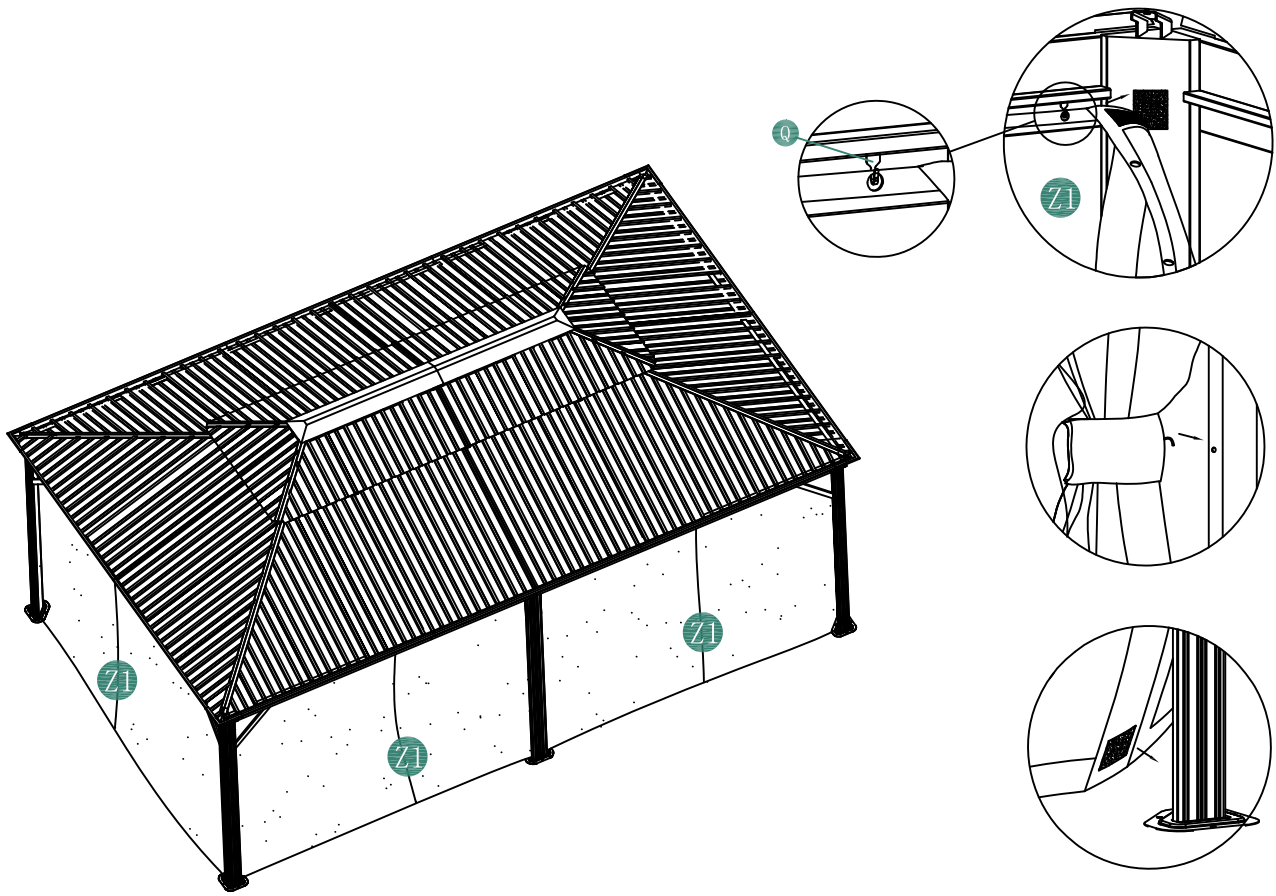

step26

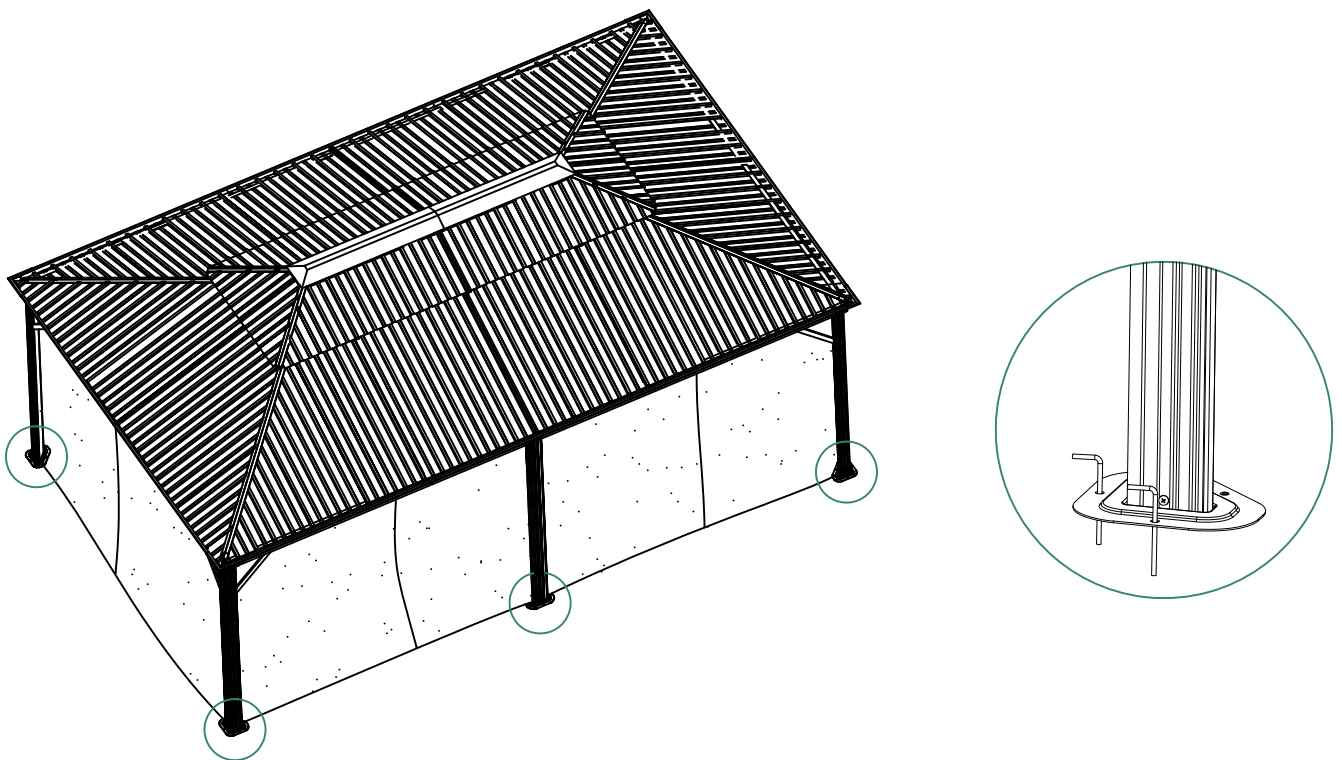



Call us First !
DO NOT RETURN TO STORE

For immediate help with assembly or product information

call our number:

(951) 213-474

Or E-mail:

service@clihome.net

Our staff is ready to provide assistance

M-F 9:00 AM to 5:00 PM EST