

### Features

- 17-gauge brass construction.
- Brass tailpiece.
- Adjustable trip lever pop-up drain.
- For above-the-floor installations.
- For use with Iron Works Historic™ freestanding baths.



### Codes/Standards







ASME A112.18.2/CSA B125.2

### KOHLER® Faucet Lifetime Limited Warranty

See website for detailed warranty information.

### Available Color/Finishes

*Color tiles intended for reference only.*

Color	Code	Description
	SN	Vibrant® Polished Nickel
	AF	Vibrant® French Gold
	PB	Vibrant® Polished Brass
	G	Brushed Chrome
	BV	Vibrant® Brushed Bronze
	2BZ	Oil-Rubbed Bronze

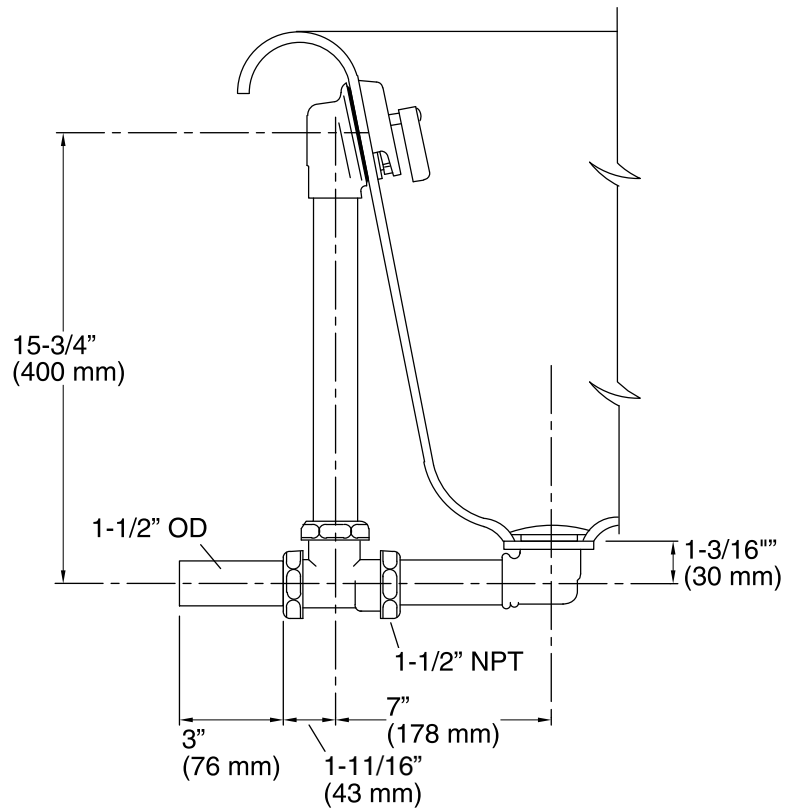

**Technical Information**

All product dimensions are nominal.

**Notes**

Install this product according to the installation guide.