

Features

- Solid brass construction for durability and reliability.
- 1-1/4" connection.
- Without overflow.
- Decorative trim cap designs.
- Snowflake design.



Codes/Standards









ASME A112.18.2/CSA B125.2

KOHLER® One-Year Limited Warranty

See website for detailed warranty information.

Available Color/Finishes

Color tiles intended for reference only.

Color	Code	Description
	CP	Polished Chrome
	SN	Vibrant® Polished Nickel
	AF	Vibrant® French Gold
	G	Brushed Chrome
	BN	Vibrant® Brushed Nickel
	BV	Vibrant® Brushed Bronze
	2BZ	Oil-Rubbed Bronze
	TT	Titanium
	VNT	Vintage Nickel

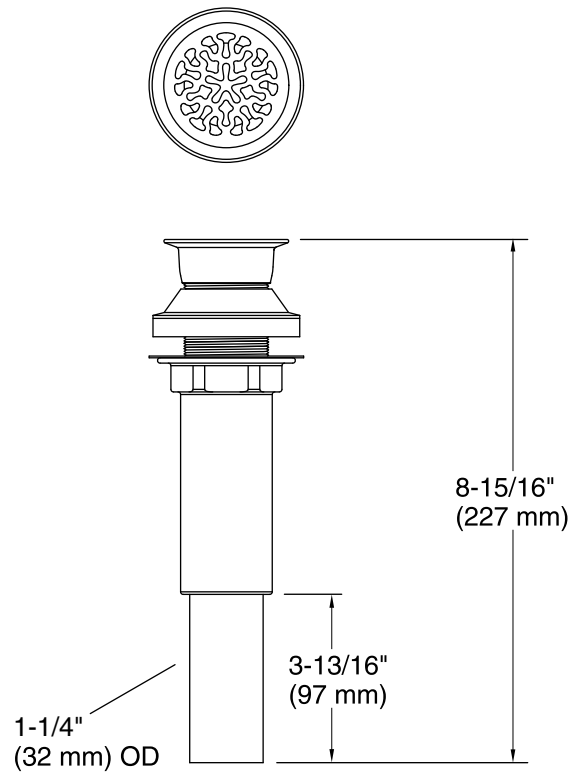

Technical Information

All product dimensions are nominal.

Notes

Install this product according to the installation guide.

A thin gasket and a thick gasket are provided with the drain. Use the thin gasket when installing the drain to bathroom sink with a thick wall [3-1/2" (89 mm) maximum thickness], such as vitreous china or cast iron. Use the thick gasket when installing the drain to bathroom sink with a thin wall, such as stainless steel or copper.