



**60 MIN**

*Approximate assembly time*



Want to see a video on how  
to assemble this product?  
**Scan the QR code**



**ASSEMBLY  
INSTRUCTIONS**  
BL19112

**CAMBRIDGE**  
6 FT FINISHING POST AND  
NO-DIG STEEL PIPE ANCHOR KIT  
(6'H)

VER. 120525

# GENERAL INFORMATION

## MISSING OR DAMAGED PARTS?



▶ **Visit Our Website**  
so we can help you right away!  
[parts.nychbrands.com](https://parts.nychbrands.com)

\* You can also reach us via phone or email.

Hours of Operation - **Weekdays 9am-5pm EST**

To better help you, **please have the following**

- ▶ Your product number (**BL19112**)
- ▶ Your affected part letters
- ▶ Your original product box

## NEED ASSEMBLY HELP?

If you are having problems with assembly or installation of this product,  
**please contact at:**

📞 **704-892-5222 / 877-234-6196**    ✉ **hmmm@wambamfence.com**

## NEED TO RETURN?

If for some reason you need to return this product, please allow us to help resolve your issues first. If you still decide to return the product, **you will need to initiate the return from the company you originally purchased from.**



**Note:** You only need one **BL19112** post to finish the run!

*Unless you are installing a gate (**BL19111**), in which case you will need two finishing posts.*

Did you buy your finishing post?



# BUYING GUIDE

## CAMBRIDGE FENCE, GATE, AND FINISHING POSTS

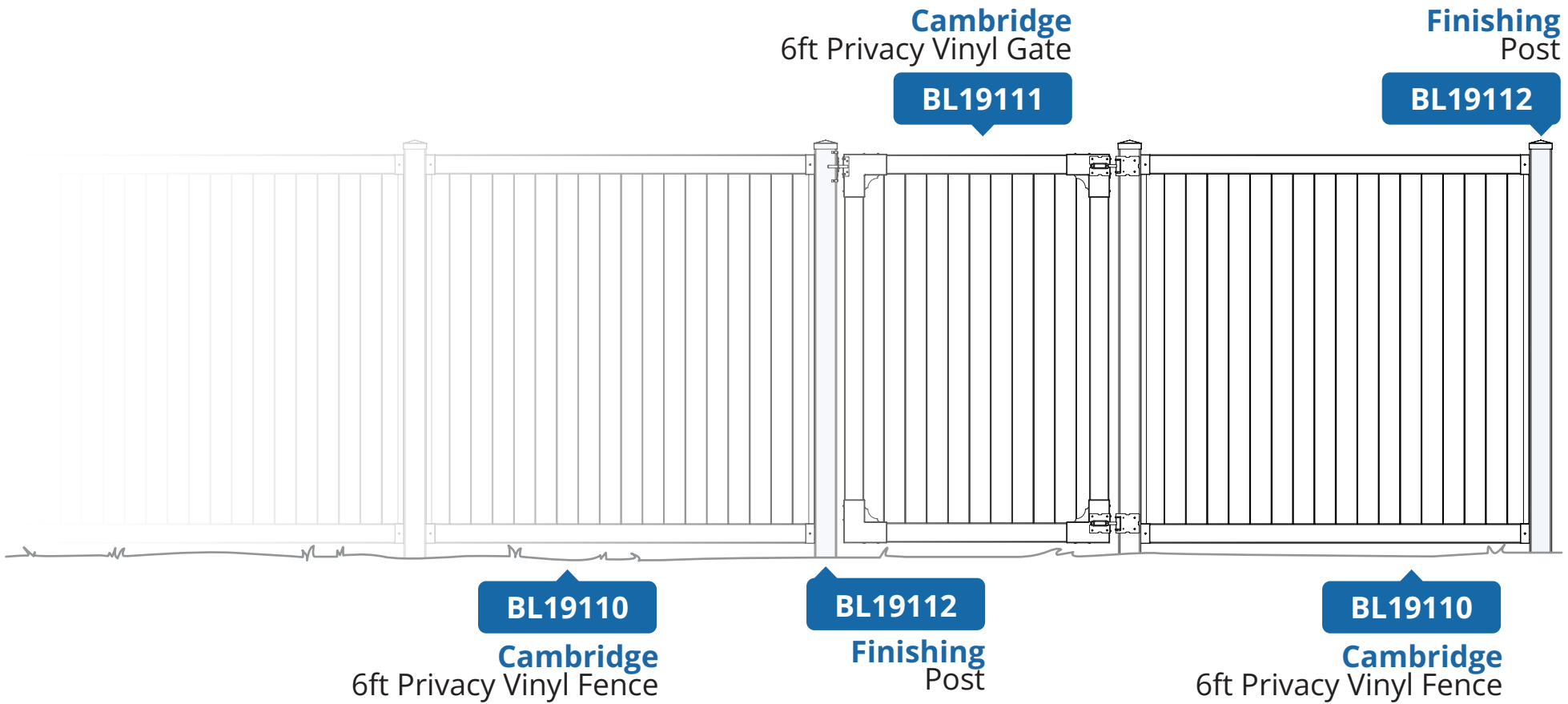

# CAMBRIDGE

## DETAILED DIMENSIONS AND SPECIFICATIONS

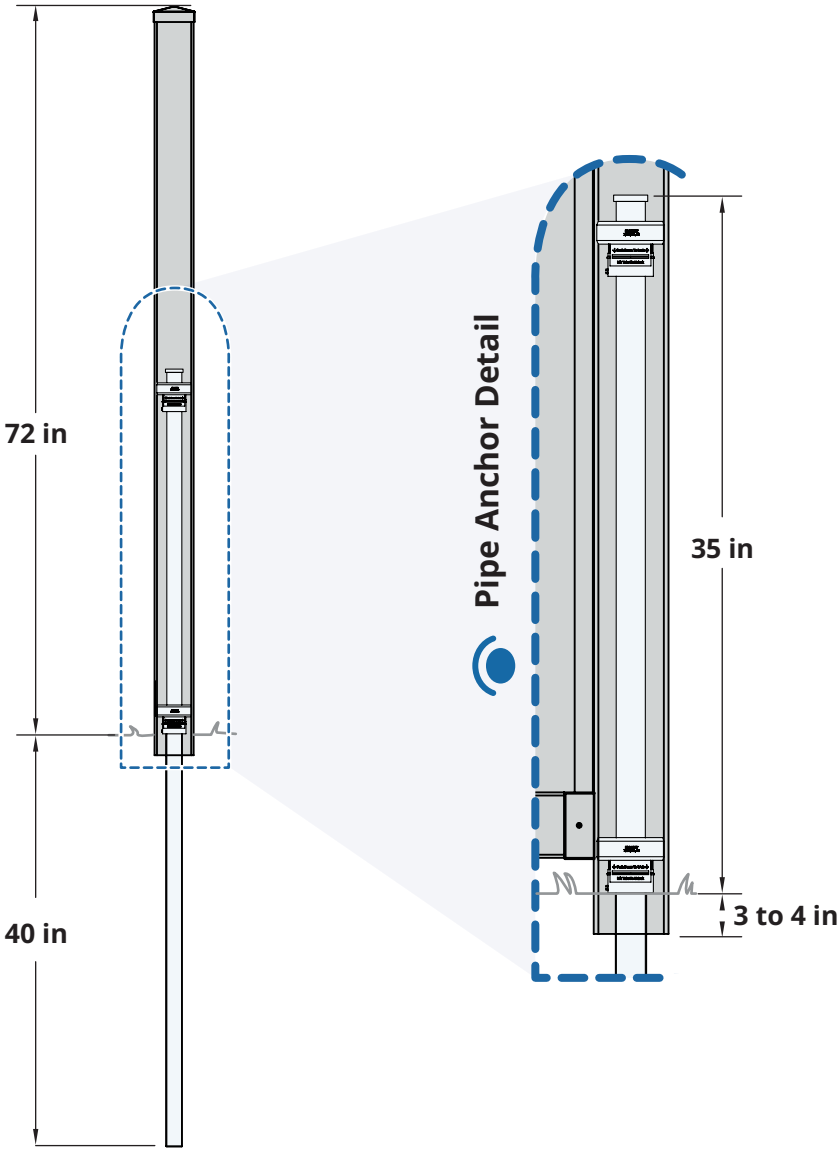

## TOOLS NEEDED

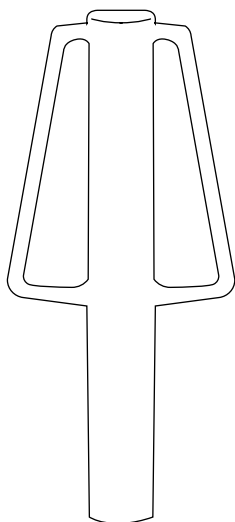

# Good

### Small Post Pounder (12-18 lbs)

- Best for small projects. These can be purchased online from Amazon, Home Depot, or Lowes

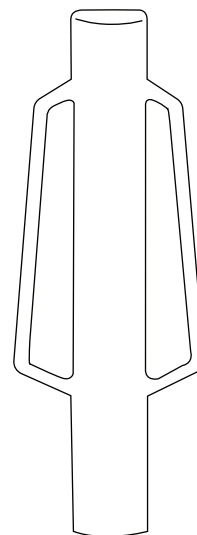

# Better

### Large Post Pounder (20+ lbs)

- Best for medium sized projects, and may require two people for smoothest operation. These can be purchased online from Amazon, HomeDepot, Lowes, the WamBam website.

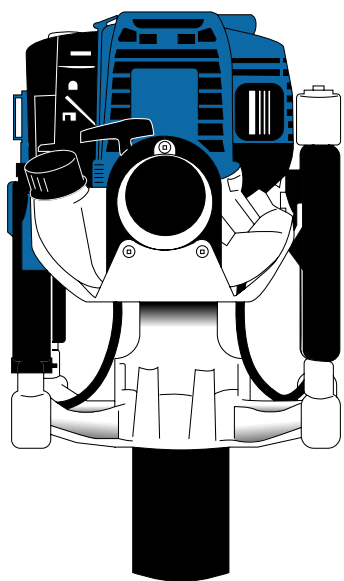

# Best

### Gas Powered Post Pounder

- Best for large projects as this option requires the least physical labor. Visit our website for rental information. Any comparable gas powered pounder will work as well.

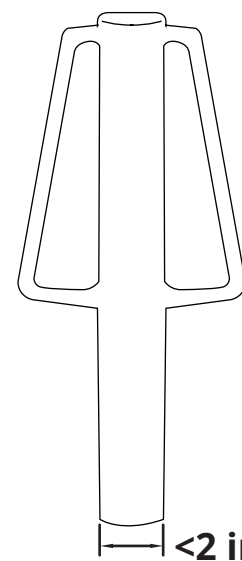

**Note:** Ensure whichever post pounder you choose has a barrel 2" or greater in diameter.

## ADDITIONAL TOOLS

**Drill**

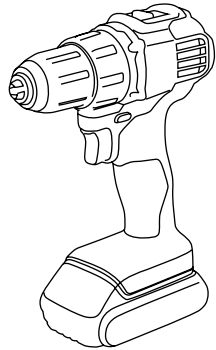

**Minimum  
2 in Drill Bit**

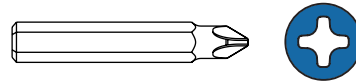

**Measuring Tape**

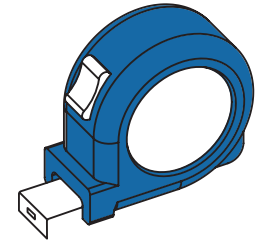

**Stringline Reel**

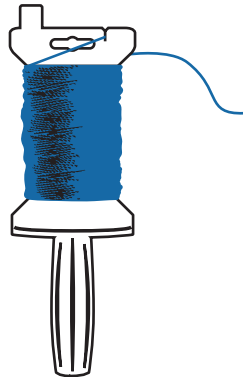

**Stakes  
(for stringline)**



**Hammer or Mallet  
(Optional for stakes)**

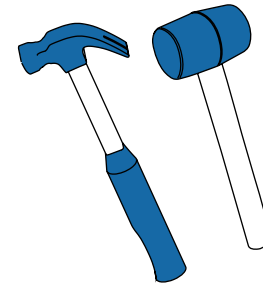

**Large Level**

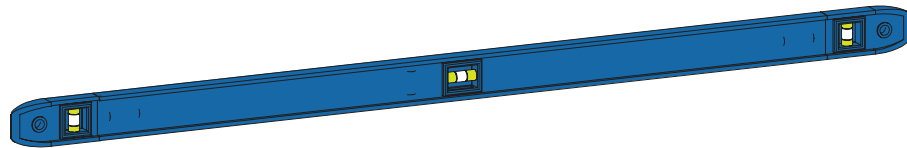

**Small Level  
(for pipe pounding)**

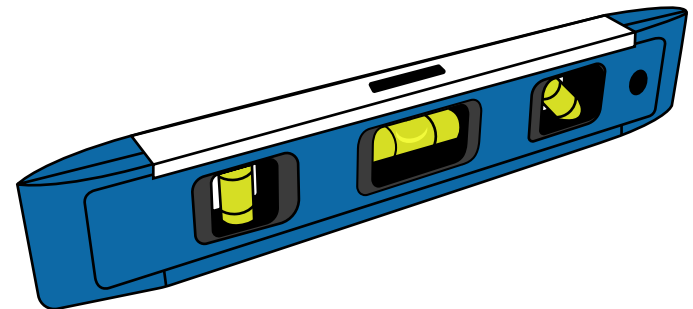

# INCLUDED MATERIALS

A

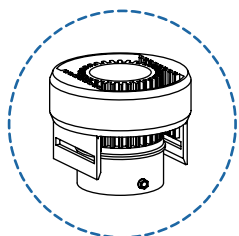

*Donut and gear*

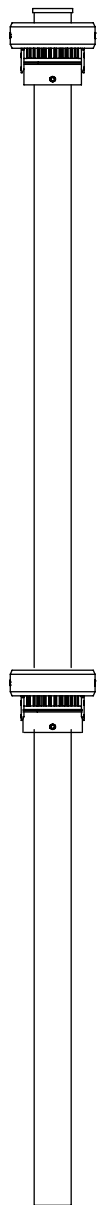

**Pipe Anchor (1)**  
1 5/8" Diameter x 78 1/2" L

B

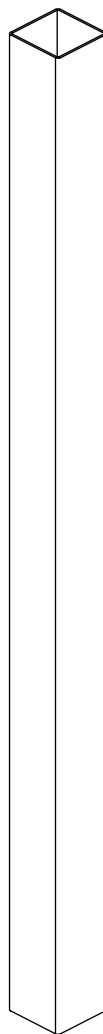

**Post (1)**  
4" x 4" x 76"

C

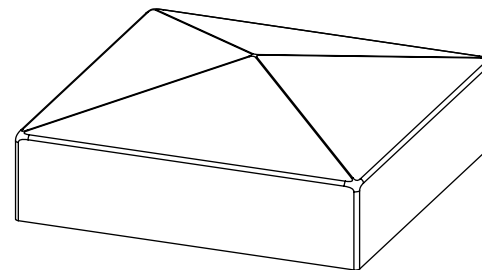

**Post Cap (1)**



**Note:** Build one full panel **FIRST** - there is a learning curve. After one panel is installed, it is most efficient to put all pipes in the ground, then build panels onto the post.

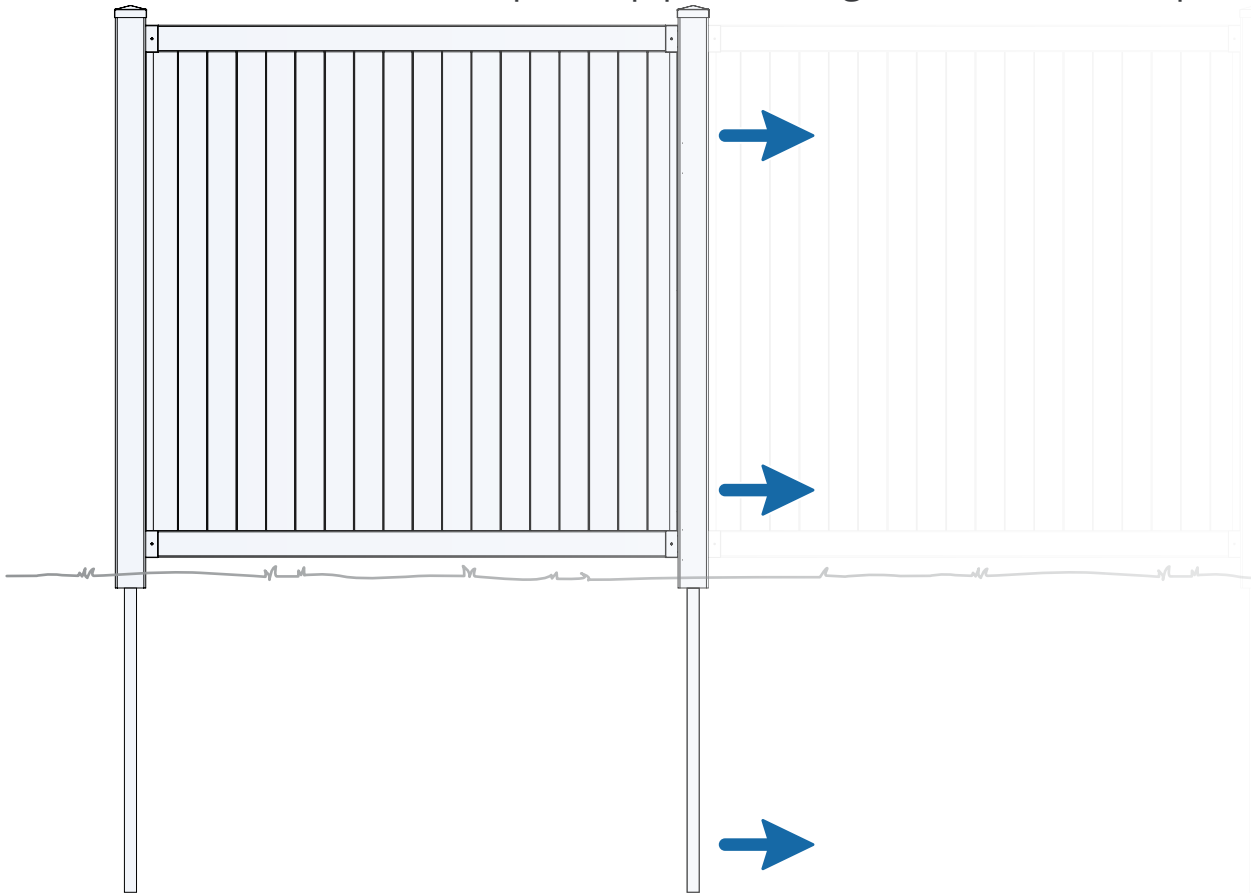

**Important:** Before you begin, we highly recommend you call **811!**





Refer to the installation guide included with your fence panels for directions on how to install your posts and pipe anchors.



# ASSEMBLY INSTRUCTIONS

BL19112



6935 Reames Rd. Ste. K.  
Charlotte, NC 28216



[hmmm@wambamfence.com](mailto:hmmm@wambamfence.com)

704-892-5222  
877-778-5733



[WWW.WAMBAMFENCE.COM](http://WWW.WAMBAMFENCE.COM)