

Features

- 33-inch minimum base cabinet width.
- Acid-resistant enamel finish.
- Top-mount.
- Three faucet holes with one accessory hole to the right.
- 33" (838 mm) x 22" (559 mm)

Material

- KOHLER® enameled cast iron.

Recommended Accessories

- K-9000 P-Trap
- K-6237 Left-Bowl Sink Rack
- K-6255 Right-Bowl Sink Rack
- K-6377 Sponge Caddy
- K-6378 Kitchen Brush Caddy
- K-6379 Kitchen Squeegee
- K-6382 Disinfecting Wipes Dispenser
- K-6383 Soap Dispenser
- K-8618 Paper Towel Holder
- K-8619 Flexible Kitchen Mat
- K-8624 Dish Scraper

Optional Accessories

- K-6194 Utility Rack With Soaking Cup
- K-6246 Cutting Board
- K-8801 Sink Strainer

Components

Product includes:

- K-6239 Colander with Cutting Board
- K-6237 Left-Bowl Sink Rack



Codes/Standards











ASME A112.19.1/CSA B45.2

KOHLER® Enameled Cast Iron Kitchen Sink Lifetime Limited Warranty

See website for detailed warranty information.

Available Color/Finishes

Color tiles intended for reference only.

Color	Code	Description
	0	White
	FF	Sea Salt™
	96	Biscuit
	47	Almond
	FD	Cane Sugar™
	95	Ice™ Grey
	G9	Sandbar
	K4	Cashmere
	20	Suede
	KA	Black 'n Tan
	7	Black Black™

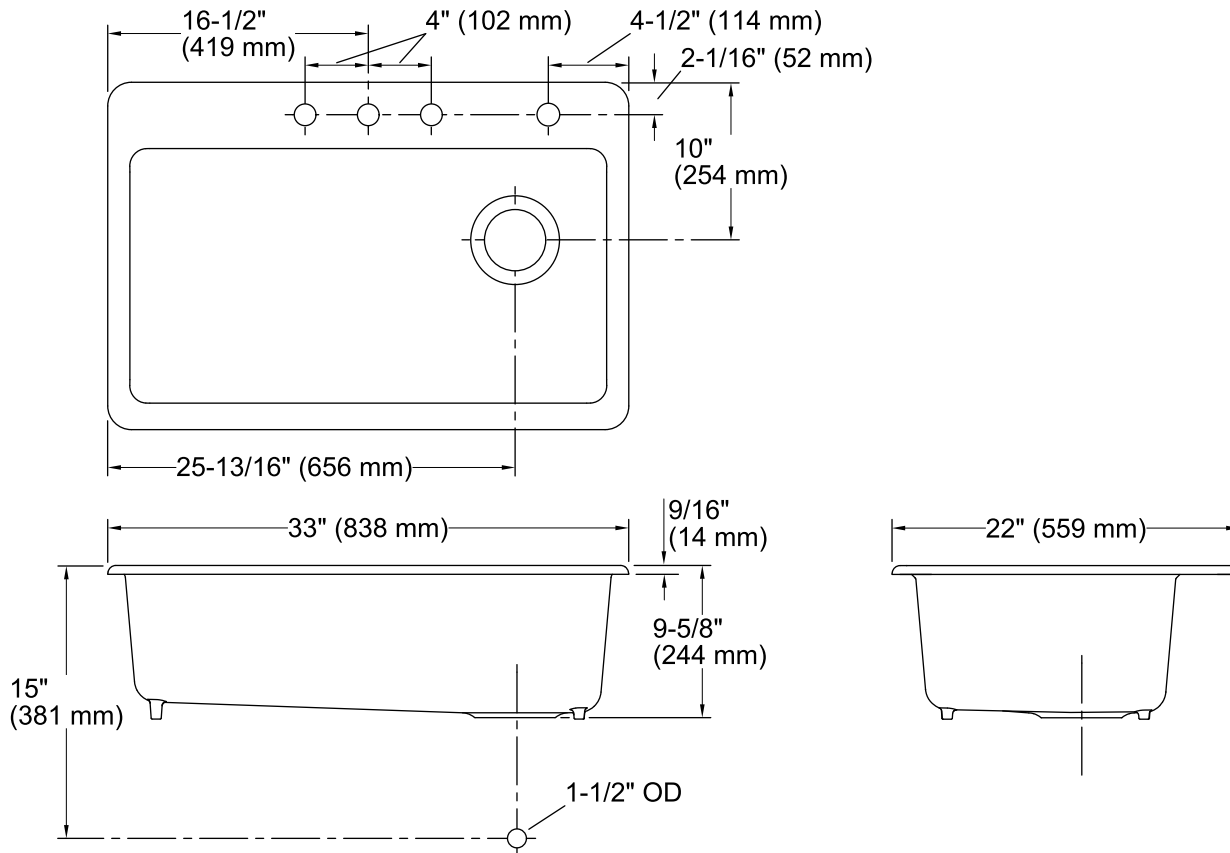

Technical Information

All product dimensions are nominal.

- Bowl configuration: Single
- Installation: Top-mount
- Bowl area (Only): Length: 30-1/4" (768 mm)
 Width: 15-13/16" (402 mm)
 Water depth: 9" (229 mm)
- Number of deck holes: 4
- Faucet hole(s): 1-3/8" (35 mm)
- Drain hole: 3-7/8" (98 mm)
- Template: 1166727-7, required, included

Notes

Install this product according to the installation instructions.

NOTICE: Countertop manufacturer or cutter must use the cut-out template provided with the product, or a current one provided by Kohler Co. (call 1-800-4-KOHLER). Kohler Co. is not responsible for cutout errors when the incorrect cut-out template is used.