

## NOTICE

- \* Please make sure that you have all parts indicated and they are in good condition before you begin assembly of this item. Refer to part list and hardware list below for guidance.
- \* This item should be assembled on a soft surface to prevent scratching the finish during assembly.
- \* This item may require periodic tightening.
- \* If you are having difficulty, our friendly Customer Care team is always here to help. Please email [customersupport@safavieh.com](mailto:customersupport@safavieh.com)





## PREPARATION

- \* Before beginning assembly of product, make sure all parts are present. Compare parts with part contents list and hardware contents list.
- \* If any part is missing or damaged, do not attempt to assemble the product.
- \* Estimated Assembly Time: 10 minutes.
- \* Tools Required for Assembly (included): Allen Key

## CARE AND MAINTENANCE

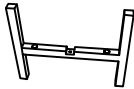
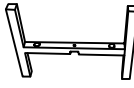
- \* Spot clean using a mild water-free solvent. Only a professional cleaner should undertake a complete overall cleaning.
- \* The use of steam or water-based cleaners may cause excessive shrinking or staining.

### Part List and Hardware List



PIECE	DESCRIPTION	PICTURE	DESCRIPTION
A	POT		1X
B	BOTTOM LEG FRAME		1X
C	TOP LEG FRAME		1X
HW1	BOLT	 Ø6x35	1X
HW2	FLAT WASHER	 Ø6x12	1X
HW3	ALLEN KEY	 Ø4x60	1X

 **SAFAVIEH**  
FURNITURE

Item ID: PAT1515

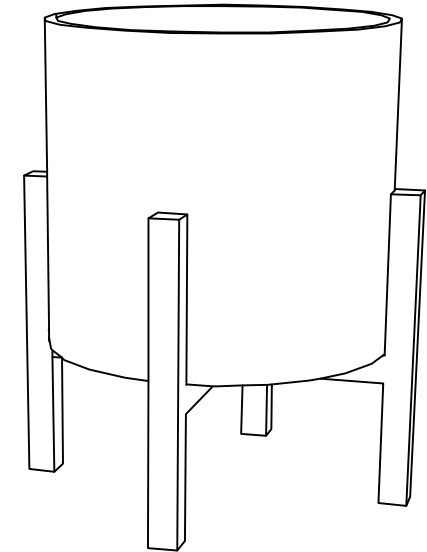
Product Dimensions: 25.3 x 25.3 x 29.3 in



 **WARNING** 

**Weight Capacity - 62 LBS**

**Warning: Do not stand on Pot**

**Warning: Do not over torque bolts**

## PREPARATION

- \* Before beginning assembly of product, make sure all parts are present. Compare parts with part contents list and hardware contents list.
- \* If any part is missing or damaged, do not attempt to assemble the product.
- \* Estimated Assembly Time: 10 minutes.
- \* Tools Required for Assembly (included): Allen Key
- \* If you are having difficulty, our friendly Customer Care team is always here to help. Please email [customersupport@safavieh.com](mailto:customersupport@safavieh.com)

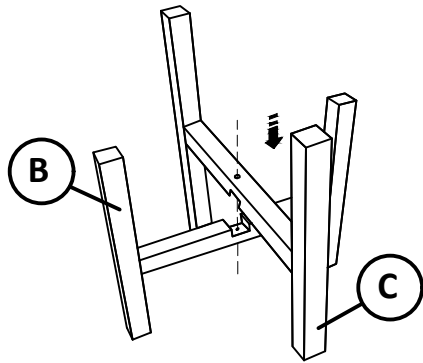

**STEP 1:** Fix the bottom leg frame ( B ) and the top leg frame (C) together

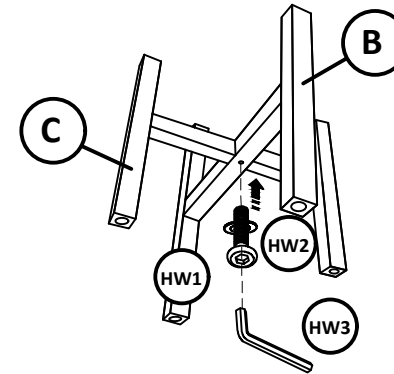

**STEP 2:** Use bolt (HW1) with the flat washer (HW2) to fix 2 leg frames. Use allen key (HW3) to tighten the bolt with sufficient force.

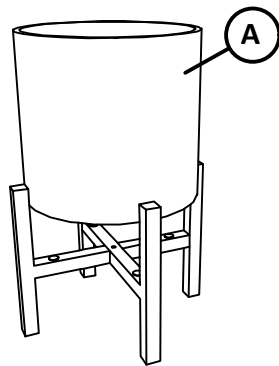

**STEP 3:** Put the cement pot on the leg frames.

