

Easy Elegance™ Ceiling Panel Installation Instructions



DESIGN CONSIDERATIONS

- **Clearance:** Easy Elegance™ ceiling panels are a drop/suspended ceiling, using Armstrong Prelude® 15/16-in Grid. You will need to have approximately 6-in of clearance above the grid face to install deep coffer panels **and** 3-in above shallow coffer panels **and only** 2.5-in above for flat panels.
- **Lighting:** Easy Elegance panels work with most modern light fixtures. Leave a 1/8-in gap between recessed light housing and panel. Additionally, the deep coffer panel is 2.5-in tall, so light fixtures may require a height extension component to provide clearance above the panel when installed. Consult local electrical code or lighting fixture manufacturer for all light fixture requirements.
- **Heat Source:** Do not install Easy Elegance products in direct contact with open flame or a heat source that can exceed 130 degrees fahrenheit. Most recessed lighting options will meet this requirement, especially modern CFL (Compact Fluorescent Lighting) and LED lights.
- **Cutting Panels for Border/Perimeter:** Cutting coffer panels is not recommended. We recommend using flat panels for all border cuts or finishing off your perimeter with drywall using our MBAC and DWAC clips installed on your 15/16-in grid.
- **Directional Installation:** Flat panels must be installed directionally. Arrows on the back of the panels will show the proper orientation.

INSTALLATION INSTRUCTIONS

(RESIDENTIAL USE ONLY)

WARNING: Panels should not be exposed to temperatures in excess of 130° F.

Some PVC products may have a protective film on the face of the tile. Please remove the film prior to installation.

MATERIALS AND TOOLS

Materials Needed:

- 12-gauge Hanger Wires and Wire Fasteners or QuickHang™ hooks and brackets
- Prelude® Main Beams and Coordinating Tees
- UHDC Universal Clear Hold Down Clips
- Easy Elegance™ Panels
- Wall Moldings (7800R)
- Main Beam Attachment Clips (MBAC) and Drywall Attachment Clips (DWAC)—for use with drywall perimeters

Tools Needed:

- Safety Glasses
- Cut-resistant Gloves
- Chalk Line
- Measuring Tape
- Hammer
- Pencil
- Utility Knife
- Metal Snips
- Carpenter's Level or Laser Level
- Drill with Driver bit
- Ball of String
- Clamps (4–6)

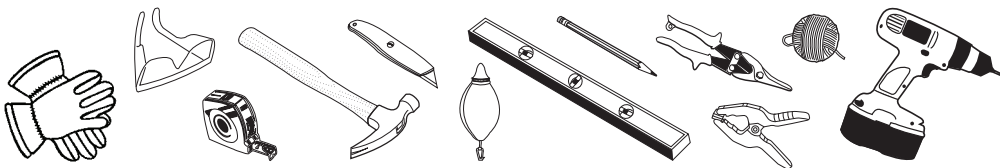

Easy Elegance™ Ceiling Panel Installation Instructions



STEP 1: PLAN LAYOUT

Sample Room Panel Layout

See *illustrations 1 & 6*

Start by determining the size of your border panels. Armstrong Ceilings recommends border panels are 1-ft or larger for a clean visual in your space. To achieve this visual, you will need to measure the room dimensions and determine how many full size panels will fit along the wall, starting with your main beam direction (mains always run opposite of the joists). This can be calculated by sectioning the length of your wall into 2-ft increments (full size panels) until you have a remainder less than 2-ft. Next, take your remainder and add 2-ft (one full size panel) and divide by 2 for equal panels on opposite sides. This number indicates your border panel size for your first wall. Repeat this process to determine the size of the border panel for the adjacent wall.

EXAMPLE: The length of Wall A (*illus. 1*) is 15-ft 7-in. Section this wall into 2-ft increments, finding a remainder of 1-ft 7-in. Now add 2-ft for a total of 3-ft 7-in and divide by 2, to get 1-ft 9-1/2-in. This is the size of the border panel for Wall A.

The length for Wall B is 11-ft 3-in. Section this wall into 2-ft increments, finding a remainder of 1-ft 3-in. Now add 2-ft for a total of 3-ft 3-in, and divide by 2, to get 1-ft 7-1/2-in. This is the size of the border panel for Wall B.

Once you know the border panel size for the adjacent wall, locate the placement of the first main beam. This will be 2-ft plus the border panel size from the wall. For Wall B, our border panel size was 1-ft 7-1/2-in, plus 2-ft for a total of 3-ft 7-1/2-in. See *illustration 1*

The remainder of the main beams are installed on 4-ft centers from the first main beam.

Install 4-ft cross tees as shown in illustration 1, then install 2-ft cross tees as shown in illustration 6. See *illustrations 1 & 6*

Grid layout, example: main beams, 4-ft tees and hanger wire.

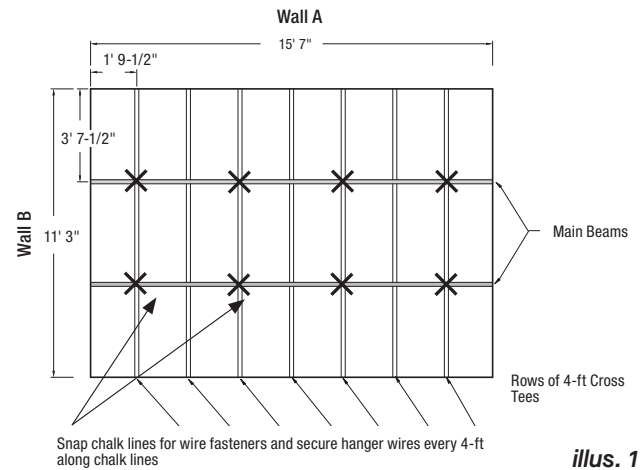

illus. 1

Example of complete installed grid system.

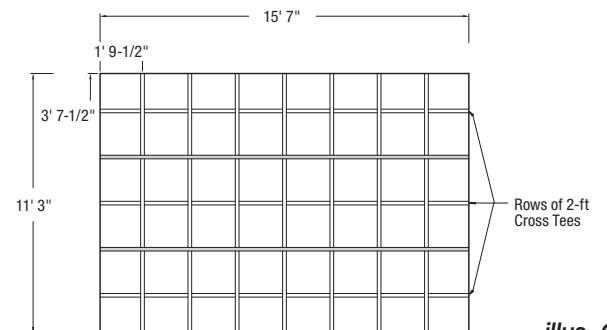

illus. 6



Easy Elegance™ Ceiling Panel Installation Instructions



STEP 2: INSTALL WALL MOLDING

See illustration 2

- Mark height desired for new ceiling (A). **REMINDER:** You need 6-in of clearance above the face of your wall molding to install deep coffer panels **and** 3-in for shallow coffer panels **and only** 2.5-in above for flat panels.
- Add height of Wall Molding and mark a level line around 3 walls (B).
- Snap a connecting chalk line on the 4th wall.
- Nail Wall Molding to the wall studs (C). Use anchors as appropriate for wall type.
- If nailing molding directly to wall is not possible (for example, a solid concrete or stone wall), hang a section of main beam next to the wall as a substitute for regular wall molding (D).

illus. 2

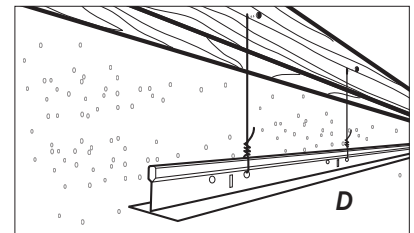
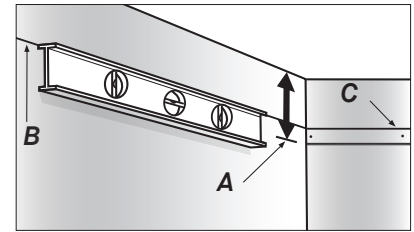

STEP 3: INSTALL SUSPENSION GRID

Install fasteners and Hanger Wires

See illustration 3

- Snap chalk lines for Main Beams 4-ft apart.
- Screw in Wire Fasteners 4-ft apart (B).
- Wrap Hanger Wire securely around itself 3 times (C).

Pre-bend hanger wires

See illustration 3

- Measure up 7/8-in from the bottom of the molding. Drive nail into wall joist just above molding.
- Do the same on the other side of the room. Stretch a string from nail to nail along a row of wires (A).
- Swing hanger wire over to string and bend each one at 90° where they touch the string (B). Stretch additional strings to prebend other hanger wires, to help level entire ceiling.
- Remove Leveling Strings after prebending wires.

NOTE: For a DIY-friendly residential installation, try QuickHang™ hooks and brackets (see Addendum for instructions).

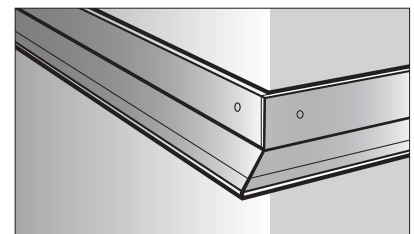

Wall molding outside corner

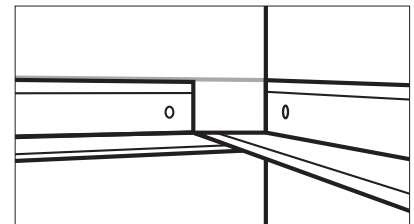

Wall molding inside corner

illus. 3

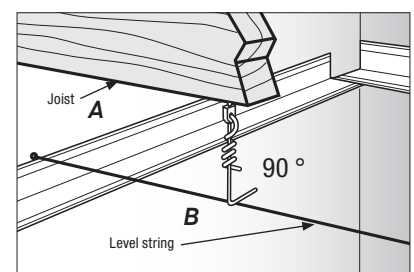
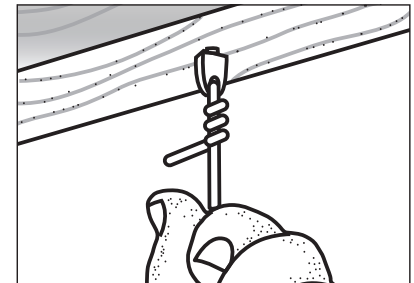

Easy Elegance™ Ceiling Panel Installation Instructions



Trim the main beam

See illustration 4

- Refer to your room layout. Trim end of first Main Beam (A) so that a Cross Tee slot on the Main Beam is the border panel distance from the wall (B). (In our example in *Illustration 1*, this is 3-ft 7-1/2-in from wall.)

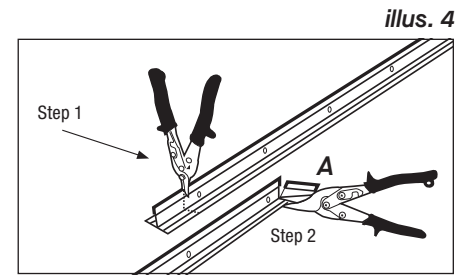

Hang the first main beam

See illustration 6

- Stretch a guide string from one end of the room to the other 1/2-in past the center of the first main and below the bottom of the wall molding.

EXAMPLE: If the first main should be 3-ft 7-1/2-in from the wall, measure out 3-ft 8-in from the wall at each end of the room and stretch the string from one end of the room to the other.

- Place the cut end of the main on the wall molding and insert a hanger wire into a hole in the main directly under the wire fastener so the wire is plumb and wrap the wire around itself at least three times.
- Insert any other wires into the main and wrap the wire around itself at least three times.

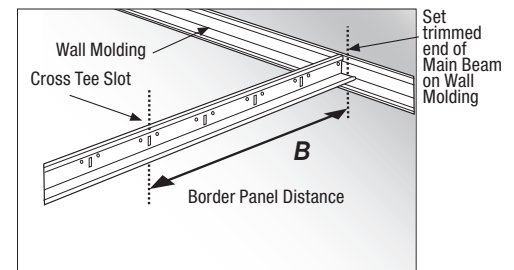

Cut Border Cross Tees

See illustration 5

- Find the location of the first border cross tee. (Border panel distance from end of main beam).
- Place the end of the white face of the cross tee against the edge of the wall molding at the side and cut the cross tee where it crosses the guide string (B).
- Insert the uncut end of the cross tee into the main and rest the cut end of the tee on the molding (A-1, *illus. 7*).
- The far edge of the main should be directly above the string.
- If you are using hook end cross tees, measure from the wall to the string and cut the cross tee to that length. The string will then line up with the near edge of the main.
- Cut the second cross tee to length and insert it.
- Temporarily fasten the tees to the wall molding so they do not move using clamp.
- *Illustration 6* shows an example of a completely installed grid system.

Squaring the Grid

See illustration 5

- Now install the first section of the second row of mains after cutting off one end so a cross tee slot is the border panel distance from the end.
- Install two four foot cross tees between the two mains in line with the first two border tees (C).
- Measure across the diagonals of the 2-ft x 4-ft opening. The measurements will be the same if the grid is square. If the measurements are not the same, shorten one of the mains until the diagonals are equal.

illus. 5

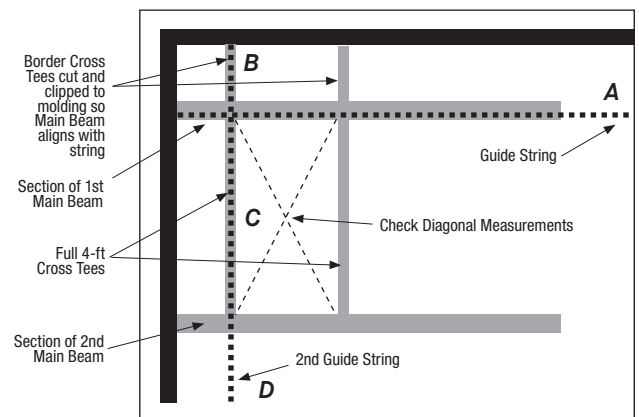

illus. 6

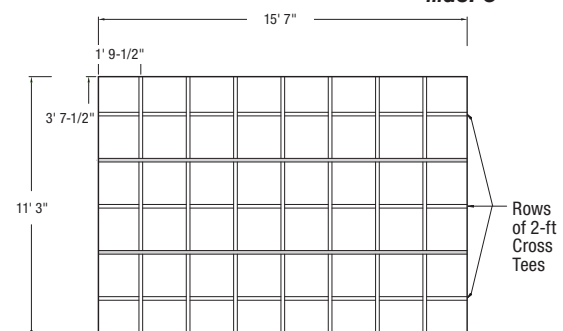

illus. 7

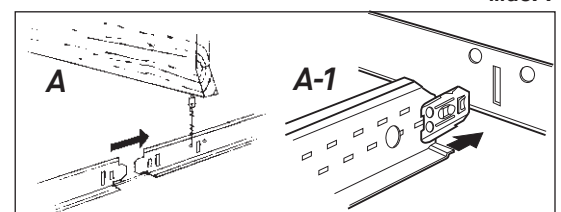

Easy Elegance™ Ceiling Panel Installation Instructions



Install Grid

See illustration 7

- Complete the rows of mains joining the ends.
- Finish cutting border cross tees between the wall and the first row of mains.
- Use the left-over ends of the mains to start other rows of mains if your room requires them.
- If you have additional rows of mains to install, stretch a second string from one side of the room to the other aligning it with the first 4 foot cross tee as shown **(D)**. See illustration 5
- This second string will be your guide for cutting the remaining rows of mains. Just measure from the end wall to the string to determine the distance for the first cross tee slot you will use.
- You must line up cross tee slots for the grid to be square!
- Measure and cut border cross tees at the other side of the room.

STEP 4: INSTALL PANELS

See illustration 8

- Cut panels that will integrate with lighting; leave 1/8-in gap between panel and recessed lighting.
- Install lights (need height extension when using deep coffer panels).
 - 2 1/2-in above grid line for deep coffer panels
 - 7/16-in above grid line for shallow coffer panels
- Cut flat panels, using a sharp mat knife.
- Install UHDC Universal Hold Down Clips as necessary to keep panels from shifting (possible near doors/windows).

illus. 8

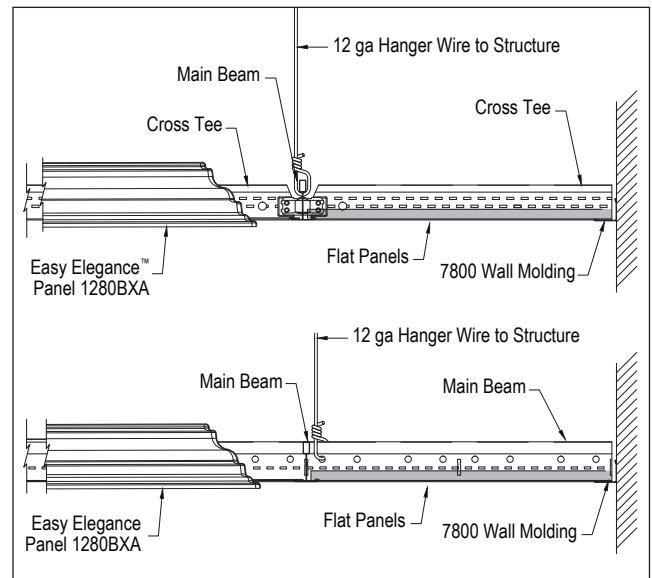

Easy Elegance™ Ceiling Panel Installation Instructions



ADDENDUM

QuickHang™ Hardware

FOR RESIDENTIAL USE ONLY:

NOTE: The QuickHang™ hardware is designed to work with solid wood and engineered wood joists in residential ceiling applications. QuickHang hardware allows for ceiling drops from 2.5" to 6" with 6" grid hook kits or 2.5" to 12" with 12" grid hook kits, below the bottom of the joists. QuickHang hardware is not for use on finished drywall ceilings.

Safety Tips

- Do not cut QuickHang hooks. If the hook needs to be shortened due to an obstruction, the top portion can be bent by hand or with pliers.

TIPS: Measure and mark your joists prior to installation. Use a string line or chalk line to align marks perpendicular to joists across the room.

How to Install the QuickHang™ Hooks and Brackets

- Hang your string line or snap your chalk line to position your main beams 4' apart.
- Make a 1" long vertical mark up the side of each joist where a bracket will be located **(A)**.
- Use the center hole in the brackets to line the brackets up with your marks **(B)**.
- Hammer in the 2 tabs for a temporary hold **(C)**.
- Nail the bracket to the joist through the two openings above the hammer tabs with the nails included in the kit **(D)**.
 - **OPTIONAL:** You can also secure the bracket to the joist with a single #5 Wood Screw through the center hole (screws not included in kit hardware).
- With the bracket securely attached to the joist, insert the grid hook using the diamond-shaped holes in the brackets. Thread the small end of the hook, from the back, through the lower hole **(E)**. Push the hook up and rotate to thread through the upper hole, squeezing the spring tabs to allow the wire to go through **(F)**.

IMPORTANT: Do not cut QuickHang hooks. If the hook needs to be shortened due to an obstruction, the top portion can be bent by hand or with pliers.

- Turn all hooks in the same direction, parallel to the joists.
- Set the hooks at about the same height; the bottom of the hooks should align with the top of the wall molding.
- To adjust the height of the hook, squeeze the upper and lower spring tabs while lifting or lowering the hook.

NOTE: You will do final leveling once all of the grid is installed.

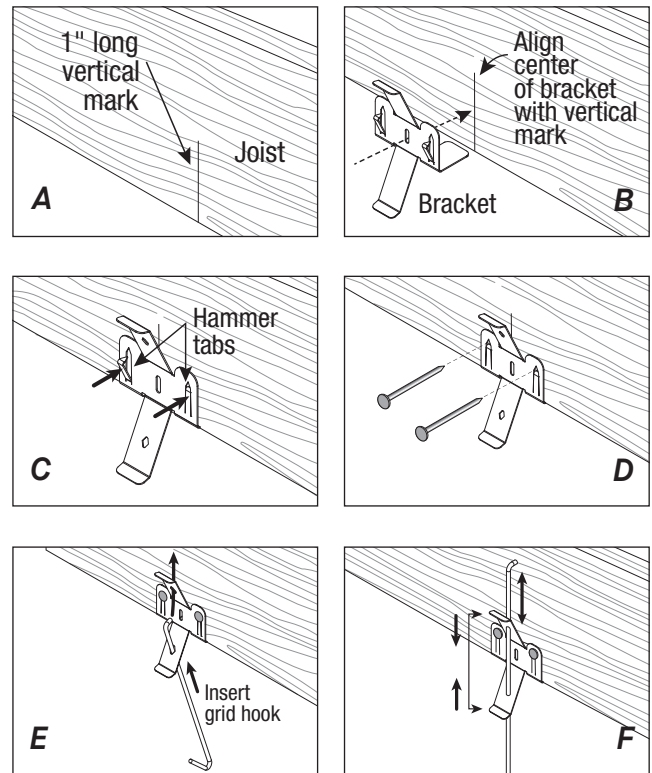

Easy Elegance™ Ceiling Panel Installation Instructions



Easy Elegance™ FAQ's

Can I paint Armstrong® Easy Elegance PVC panels?

- All Armstrong Easy Elegance products can be painted with latex paint before installation. Make sure that your ceiling panels are clean and dry, and experiment on a sample with your paint of choice before painting the ceiling in its entirety. Field painting will void the warranty.

Are Armstrong Easy Elegance panels fire rated?

- All Armstrong Easy Elegance products meet residential building codes for safety. While we do not recommend for commercial use, local code officials can provide guidance.

Are your ceiling tiles moisture resistant?

- Our rigid PVC ceiling tiles are extremely moisture resistant. In fact, they are unaffected by humidity, and will not absorb water at all. They are moisture, mold and mildew resistant.

Can I mount Armstrong Easy Elegance Panels directly to my ceiling?

- Our lightweight designs are made exclusively for grid mount/drop ceiling applications.

Will air flow cause my tiles to lift out of the ceiling grid?

- For normal installations, most designs do not require hold down clips. Hold down clips are only required in extreme conditions. If there is a rapid change in the air pressure above and below the tiles, they may move. You can purchase hold down clips (Item #UHDC) if you feel that you will need them for your ceiling tile installation.

Where can I find black grid?

- You can purchase a 24-in × 24-in black Suspended Ceiling Installation Kit (model #6362BL). Each kit includes everything you need to install 64-sq ft of panels.

How do I maintain my panels?

- Simply wipe clean with a damp cloth.

DANGER! This product contains titanium dioxide and carbon black* which may be released upon sawing, sanding or machining

Hazard Statements: Causes skin irritation. Causes eye irritation. May cause damage to lungs through prolonged or repeated exposure. May cause respiratory irritation. Panels do not release respirable dust in their installed state and do not present any known health hazards when installed and properly maintained. **⚠️ WARNING:** Drilling, sawing, sanding or machining this product can expose you to titanium dioxide and carbon black*, substances known to the State of California to cause cancer. For more information go to www.P65Warnings.ca.gov

Precautionary Measures: During the installation, be certain that the work site is well ventilated and avoid breathing dust. Avoid contact with skin or eyes. Wear long-sleeve, loose fitting clothes, gloves, and eye protection. Cut and trim with knife, razor, or hand saw. Do not cut with power equipment unless either a dust collector is used on the equipment or local exhaust is adequate and a NIOSH approved respirator is worn to prevent overexposure to airborne titanium dioxide and carbon black*. **For additional information, refer to the Safety Data Sheet at www.armstrongceilings.com**

First Aid Measures: If eye or skin contact occurs, flush with plenty of water for at least 15 minutes and remove contaminated clothing. After installing material, wash with warm water and mild soap. Wash work clothes separately from other clothing. Rinse washer thoroughly.

**Black PVC tiles only.*

For additional information on installing Easy Elegance ceilings, including special installation tips, please visit our website at ceilings.com/easyelegance or call customer service at 1 877 ARMSTRONG (276-7876).

For warranty information, please visit ceilings.com/warranty