

DUCTLESS MINI SPLIT SYSTEM AIR CONDITIONER / HEAT PUMP

---

# PIONEER®

## UYT-24 Inverter Series

For 18,000-22,200 BTU/hr Systems

*Quantum Ultra (R-454B) - UT Indoor and YN Outdoor*

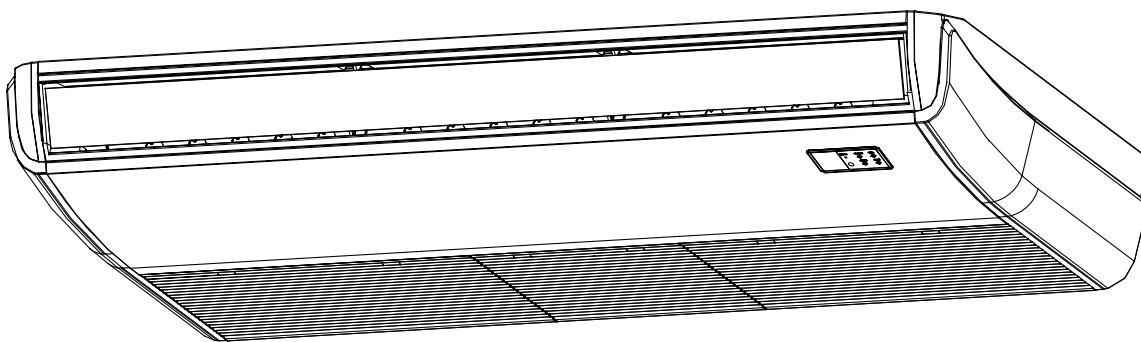

# Installation & User Manual

### Note

Intended for use with **Single-Zone Split Systems**. If the indoor sections will be installed as part of a **Multi-Zone System**, refer to the supplemental instructions provided with the Multi-Zone Outdoor Unit for complete and accurate guidance. Certain specifications—such as minimum floor area requirements—may differ, and are outlined in more detail within the **Multi-Zone Section** documentation.

### IMPORTANT NOTICE:

Read this manual carefully before installing or operating your new air conditioning system. Be sure to save this manual for future reference.



REV250602

# Table of Contents

<b>1</b>	Safety Precautions.....	2
<b>2</b>	System Components.....	4
<b>3</b>	Included Accessories.....	5
<b>4</b>	Indoor Unit Overview.....	6
<b>5</b>	Operating Instructions.....	7
<b>6</b>	Maintenance.....	19
<b>7</b>	A2L Refrigerant.....	20
<b>8</b>	Indoor Unit Installation.....	30
<b>9</b>	Outdoor Unit Installation.....	40
<b>10</b>	Electrical/Gas Leak Check & Test Run....	49
<b>T</b>	Troubleshooting.....	51
<b>A</b>	Appendix.....	55

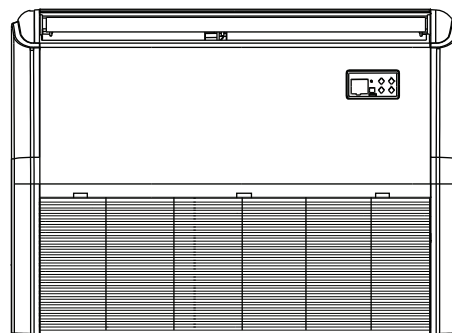
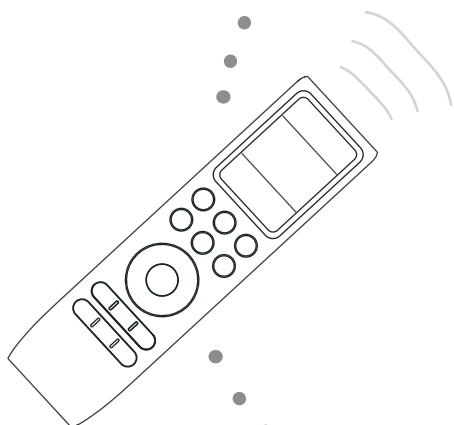
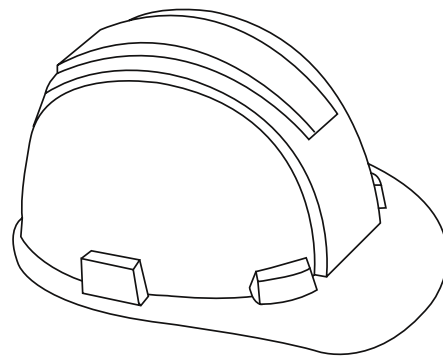

# Safety Precautions

# 1

## *Read and Understand All Safety Precautions Prior to Installation*

Improper installation due to negligence of instructions may result in death, property damage, or serious injury. The magnitude of the potential damage or injury is classified as either a Warning or Caution.



### Warning

This symbol indicates that ignoring the related instructions may cause death or serious injury.



### Caution

This symbol indicates that ignoring the related instructions may cause moderate injury to nearby individuals and/or damage to the appliance or other property.



### Danger

This symbol indicates that you must never perform the action shown.



### Warning

- ⊘ Do not power the system using an extension cable or with wiring smaller than the specified gauge. Do not share the electrical cable with other appliances. Improper or insufficient power supply can cause undesirable operation, fire, or electrical shock.

- ⊘ When connecting the refrigerant piping, do not allow any substances or gases other than the specified refrigerant to enter the unit. The presence of other gases or substances will lower the unit's capacity, causing abnormally high pressure in the refrigeration cycle. This can cause an explosion or injury, as well as permanent equipment failure. **Note:** No dust, humidity, or air is allowed to enter the unit.

- ⊘ Do not allow children to play with or around the air conditioner. Supervise children near the unit at all times.

1. Trained personnel must complete the installation according to the applicable codes. Defective installation can cause water leakage, electrical shock, or fire. Using the proper tools is required.

2. Perform the installation according to the instructions. Improper installation can cause water leakage, undesirable performance, electrical shock, or fire. In North America, an authorized personnel must perform the installation in accordance with the requirements of NEC and CEC.

3. If the unit requires repairs or maintenance, contact a qualified and licensed HVAC technician.

4. Only use the included accessories, parts, and specified items for installation. Using non-standard parts can cause water leakage, electrical shock, fire, and total unit failure.

5. Install the unit on top of a firm structure that can fully support its weight. If the chosen location cannot support the unit's weight or the installation is not done properly, the unit may fall and cause serious injury and damage.

# Safety Precautions

# 1



## Warning

6. For electrical work, follow all local and national wiring standards and regulations, especially in this installation manual. You must use an independent circuit and dedicated breaker to supply power. Do not connect other appliances to the same circuit. Insufficient electrical capacity or defects in electrical work can cause electrical shock or fire.
7. For all electrical work, use the specified cables. Connect cables tightly, then clamp them securely to prevent external forces from damaging the terminals. Improper electrical connections can overheat, causing fire and electrical shock.
8. Properly arrange the wiring to ensure that the control board cover can close correctly. If the control board is not closed properly, it can lead to corrosion and cause the connection points on the terminal to heat up, catch fire, or cause electrical shock.
9. Use specially designed air conditioners for functional environments, such as kitchens, server rooms, etc.
10. If a part of the electrical wiring is damaged, a certified service agent or similarly qualified technicians must replace the wiring in order to avoid a hazard.
11. Children aged 8 and above, as well as individuals with lack of experience or reduced physical, sensory, or mental capabilities can use the appliance if supervision or instruction is given. Do not allow children to play with or near the appliance. Children or untrained personnel should be restricted from cleaning and performing maintenance on the appliance, unless they're given supervision.



## Caution

- ⊘ For units with an auxiliary electric heater, do not install the unit within 3 feet (1 m) of any combustible materials.
  - ⊘ Do not install the unit in a location that may be exposed to combustible gas leaks. If combustible gas accumulates around the unit, it may cause a fire.
  - ⊘ Do not operate the air conditioner in a highly humid space, such as bathrooms or laundry rooms. Exposure to high humidity or water can cause electrical components to short circuit.
1. The product must be properly grounded during the duration of the installation process, otherwise electrical shock may occur.
  2. Install the drainage piping according to the instructions in this manual. Improper drainage may cause water damage to your home and property.

## Notes about Fluorinated Gases

1. This air conditioner contains fluorinated gases. For specific information on the type of gas and amount, refer to the relevant label on the unit.
2. Qualified and well-trained personnel must complete the installation, repair the unit, and perform service and maintenance.
3. A certified HVAC technician must remove and recycle the product.
4. If the system has a leak-detection feature installed, check its functionality at least every 12 months.
5. When checking the unit for leaks, it is recommended to properly log and record all checks.

# 2

## System Components

### Ceiling-Mounted Cassette Air Conditioner

The system is made up of two units connected together via insulated copper pipes and an electrical communication cable. Mount the indoor unit and panel to the ceiling or floor of the room intended to be air conditioned. Install the outdoor unit on the ground outside or on the wall of the dwelling using suitable mounting brackets.

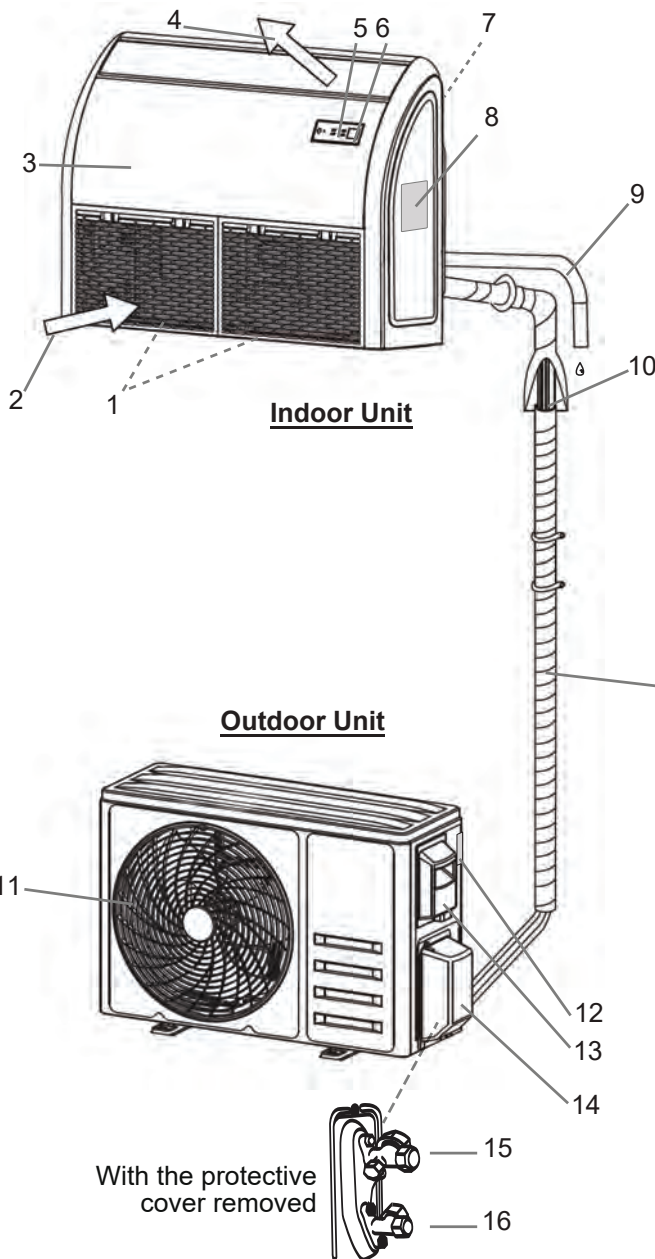

No.	Description
1	Anti-dust air filters
2	Air return inlet
3	Air handler body front panel
4	Supply air outlet
5	Operation lights/indicators
6	Infrared receiver
7	Air handler hanging brackets
8	Model nameplate
9	Condensate drain
10	Refrigerant piping

No.	Description
11	Air outlet grille
12	Outdoor unit nameplate
13	Terminal block cover
14	Valve protection cover
15	Gas (Suction) line valve
16	Liquid line valve

**Note:** Serial numbers are typically located behind the electronic control box cover cap of either unit.





**Note:** The illustrations are a simplified diagram of the appliance and may not fully reflect the system's actual appearance. Technical data is printed on the system's labels.







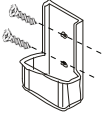
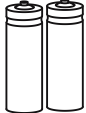

# 3

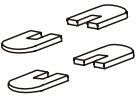
## Included Accessories

### Accessories & Components

The air conditioning system comes with the following accessories. The asterisk items are sold separately. Use all of the installation parts and accessories to install the air conditioner. Improper installation may cause the equipment to fail, or result in water leakage, electrical shock, or fire.

Name	Appearance
1x Installation and User manual	
1x Warranty card	
1x Communication/Signal cable*	
1x Insulated copper pipe*	
1x Remote controller	
1x Remote controller holder	
2x Remote controller batteries	

Name	Appearance
1x Outdoor unit rubber pads* (For the feet when ground mounting)	
1x Drain pipe assembly	
1x Plastic drain joint plug for the outdoor unit (Use only for wall-mounted condensers)	
1x Condensate drain hose*	
1x Wrapping tape*	
1x Wall-hole packing sealant*	
1x Wall sleeve*	
1x Allen wrench for opening service valves	
1x Anti-leak flare sealant gel*	

Connecting Pipe Diameters		
BTU Capacity	Gas Line	Liquid Line
18,000	1/2"	1/4"
22,200	5/8"	1/4"







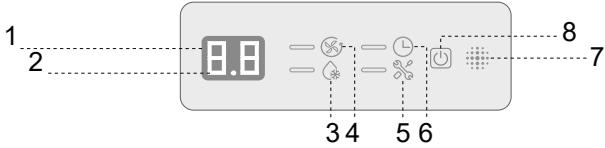

**Note:** Items with an asterisk \* may be sold separately and are sometimes supplied by the installer. Therefore, some items may differ in appearance, shape, or length, depending on the particular installation.

# Indoor Unit Overview

# 4

## Front Panel Interface Display Layout



No.	LED Icon	Symbol	Description
1	Signal Receptor		Receives signals from the handheld remote controller
2	Digital Display		Displays temp. settings, error codes, and operational status
3	Defrost Indicator		Indicates that the unit is either in defrost mode or preheating
4	Operation Light		Indicates that the system is operating normally.
5	Alert Indicator		Illuminates to indicate a system fault or abnormal condition
6	Timer Indicator		Shows that a timer function has been activated
7	Tone Emitter		Emits confirmation tones when receiving command signals
8	Manual Button		Manually powers the unit on or off without using the remote

 The shape and positions of the switches and indicators may vary according to the model, however the functions remain the same. There may be variances between the amount of digits that are shown on the remote controller (3) vs. the amount on the indoor unit (2).

 It is important not to obstruct the front panel, otherwise it may not be able to receive infrared commands from the remote controller. Ensure that the panel is not covered with paint or adhesive layers, and that all signal-emitting devices are kept away.

## Emergency Manual Button & Auto-Restart Function

The emergency button is located on the front panel of the unit on the primary interface module.

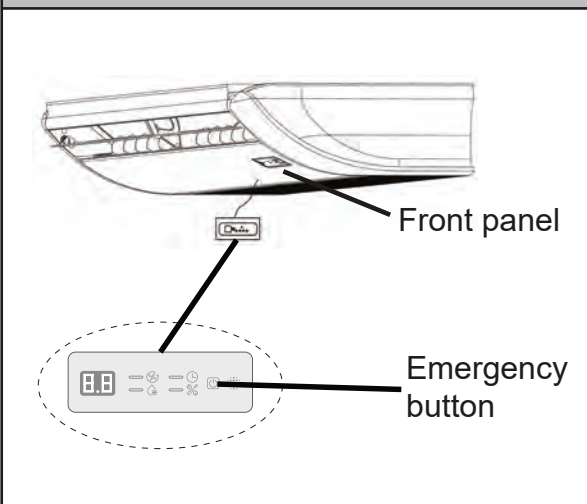

### Emergency Manual Button

If the remote controller fails to operate the system, follow these steps:

1. Open and lift the front panel up at angle to gain access to the emergency button.
2. Press the manual button once to start the unit in Cooling mode.
3. Press the button again within 3 seconds to start the unit in Heating mode.
4. Press the button a 3rd time within 5 seconds to turn off the unit.

### Auto-Restart Feature

This appliance is programmed with an Auto-Restart function.



In case of sudden power failure, the control module will remember the settings configured before power loss.

When power is restored, the unit will restart automatically and be set to the previous settings, which were preserved with this memory function.



# Operating Instructions

# 5

## Remote Buttons Overview

Button	Description
	Turn the air conditioner on or off
TURBO	Activate/deactivate the Turbo feature to allow the system to rapidly reach set temperatures
MUTE	Put the system into Silent mode
MODE	Select the mode of operation (Auto, Cool, Dry, Fan, and Heat modes)
ECO	Activate/deactivate the ECO feature
	Long press to activate the 46°F "Away from Home" freeze protection setting
TIMER	Configure the automatic on/off times
^	Increase set temperature and timing, as well as navigate the functional menu
v	Decrease set temperature and timing, as well as navigate the functional menu
FAN	Configure the fan speed (Auto, Low, Mid, and High)
	Activate/deactivate the up-down louver motor
	Activate/deactivate the left-right louver motor
DISPLAY	Turn the LED display on or off
SLEEP	Toggle the system's Sleep mode
I FEEL	Activate/deactivate the system's Follow Me mode
MEMORY	Recall saved temperature/mode/fan settings
CLEAN	Activate/deactivate Self-Clean mode
ACC	Reserved for future usage
[LOCK]	Hold MODE+TIMER for child-lock



-  The display and some features of the remote controller may vary according to the model of the system.
-  The shape and positions of the buttons and indicators may vary according to the model of the system, but the features and functionality would remain the same.
-  The unit will confirm the successful reception of each button command with a beep.

# Operating Instructions

# 5

## Remote Controller LED Screen & Icons

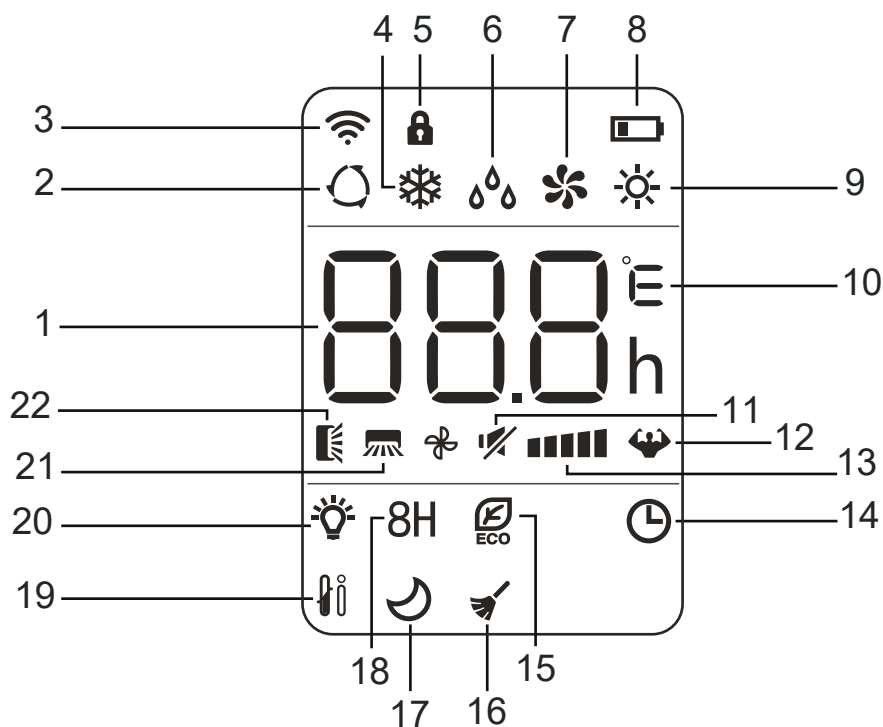

No.	Icon	Description
1	8.8	Temperature indicator
2	⌚	Auto mode
3	📶	Signal transmit indicator
4	❄️	Cooling mode
5	🔒	Child lock indicator
6	💧	Dry mode
7	🌀	Fan Only mode
8	🔋	Battery level indicator
9	☀️	Heating mode
10	°C/°F	Unit of temperature (°C/°F)
11	🔇	Mute function

No.	Icon	Description
12	🌀	Turbo mode
13	🌀	Fan speed (Auto or Fixed)
14	🕒	Timer active indicator
15	ECO	ECO mode
16	🧹	Self-Clean function
17	🌙	Sleep function
18	8H	8°C (46°F) Heating function
19	👤	I Feel/Follow Me mode
20	💡	LED display on/off
21	↔️	Left-Right swing indicator
22	↕️	Up-Down swing indicator

### Note on Illustrations

The illustrations in this manual are strictly for explanatory purposes. The actual display and some functions of the remote controller may vary according to the manual purchased.

# Operating Instructions

# 5

## Replace Batteries

Slide the battery cover on the rear of the remote down in the direction of the arrow. Install batteries according to the depicted directions (+ and -) as shown on the remote controller. Slide the cover back into place.

 Use 2x AAA batteries. Do not use re-chargeable batteries. Replace the old batteries with new ones of the same type when the display is no longer working. Do not dispose of batteries as unsorted municipal waste. Disposal of such waste separately for special treatment is necessary. If the system will not be used for a long time, remove the batteries to prevent leakage.

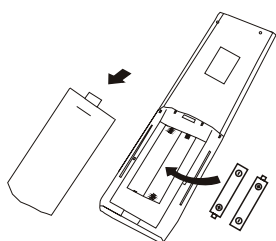

**Note:** Remove batteries to avoid leakage damage when not being used for a long time.

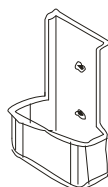

**Note:** Place the remote controller inside the cradle when not in use (may be sold separately).

## Configure Remote Controller Settings (Some Models)

Depending on the system, the control type (Cooling Only or Heat Pump) and the unit of temperature (°C or °F) can be configured using the controller buttons. Operate as below. **Complete the configuration as soon as the batteries are inserted into the remote.**

Press and Hold	Functional Result
Mode	When ❄️ flashes, Cooling Only mode
Mode	When ☀️ flashes, Heating Only mode
Turbo ↓ Turbo (press)	After 5 seconds, enter Change mode ↓ Switch between °C and °F units

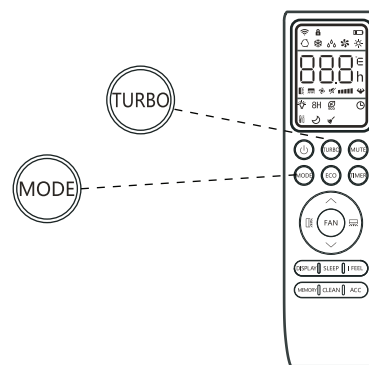

Remove the batteries and re-insert them to reprogram as many times as needed.

## Operate the Remote Controller Successfully & Safely

- Ensure no objects come between the remote controller and signal.
- Keep the remote at least 3 feet (1 m) away from televisions and other electrical appliances.
- Always direct the remote controller toward the air conditioner.
- Do not leave the remote controller exposed to sun rays.

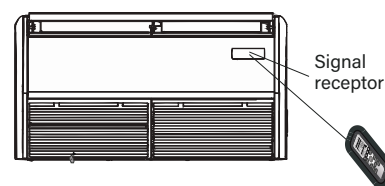

# Operating Instructions

# 5



## Regarding the Airflow of the Indoor Unit

The air that is pulled in by the fan (the "return air") enters the grille and is passed through the filter. The air is then cooled/dehumidified/heated through the heat exchanger.

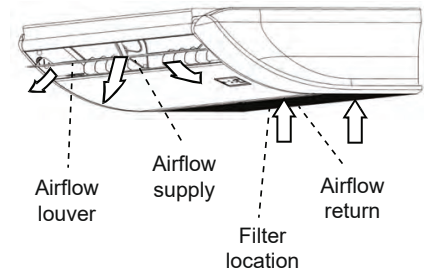
The direction of the air output is manipulated up and down by the motorized louver, as well as left to right by the manually controlled vertical deflectors. Some models may come with "dual-swing" capability, which offers both a horizontal and vertical motorized air flow swing.



## Control the System's Airflow

1. Press the   buttons to activate the air direction adjusters.

Press the Swing  button to trigger the horizontal flaps to swing up and down. Press the button again to stop the swing movement at the current angle.

Press the Swing  button to trigger the vertical flaps to swing left and right. Press the button again to stop the swing movement at the current angle.

2. If the vertical deflectors, which are located underneath the flaps, are adjusted manually, they can be used to fix the airflow in a certain vertical position before turning the system on.

**Note:** For some models, press either of the Swing buttons for more than 3 seconds to allow more fine adjustment of the airflow angle.

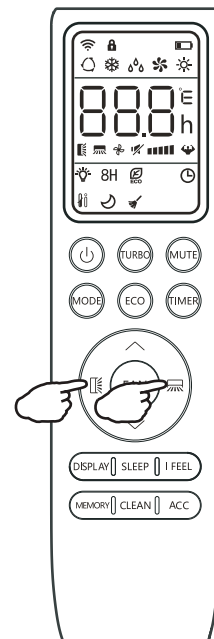

### Caution

- Do not manipulate the louvers themselves manually or serious damage may occur.
- Only make deflector adjustments when the system is switched off.
- Never poke fingers, sticks, or other objects into the air inlet/outlet vents.

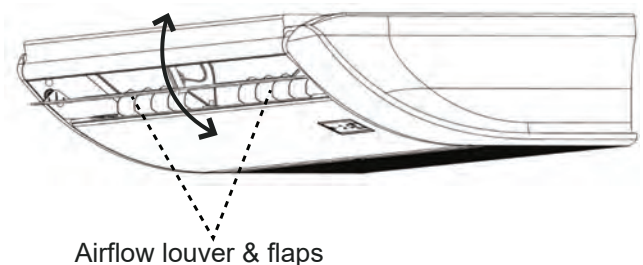





# Operating Instructions

# 5

## Cooling Mode



Cooling mode utilizes the heat pump to cool the room while also reducing the humidity of the air in the room.



To put the system into Cooling mode, press the  button until the  symbol appears on the remote controller's display.

Use the  and  buttons to set a temperature lower than that of the room.

## Heating Mode

Heating mode utilizes the heat pump to warm the air in the room by reversing the cooling cycle.

To put the system in Heating mode, press the  button until the  symbol appears on the remote controller's display.

Use the  and  buttons to set a temperature higher than that of the room.

**Note:** The system may take up to 10 minutes before it begins delivering heat, allowing the coil to warm up and prevent cold airflow.

Fan speed is not available to the user in the same way as Cooling mode. Rather, the fan will blow out air at a speed that is in proportion to how much the heat exchanger has been warmed up to.

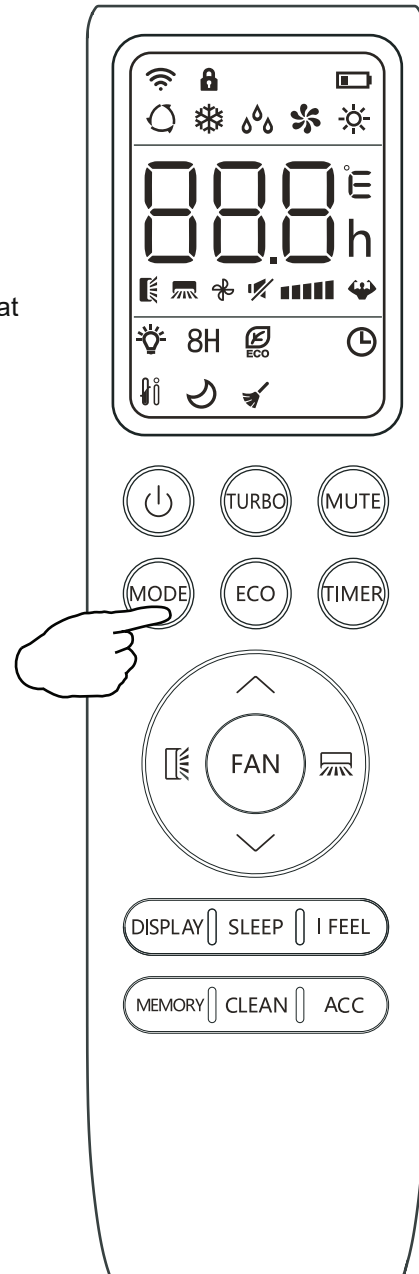

### Note

In Heating mode, the appliance will periodically enter a defrost cycle, which is essential in order to clean frosting off the condenser and recover heat exchange capabilities. The process is normal and lasts for 2-10 minutes.

During defrosting, the indoor unit's fan will cease operation. After the cycle is completed, the system will resume its normal Heating mode operation automatically. Press the ECO button 10 times in 8 seconds to trigger a forced defrost.

# 5

## Operating Instructions

### Dry Mode

Dry mode is a limited function that can rapidly reduce the humidity/moisture of the room.

To put the system into Dry mode, press the **MODE** button until the  symbol appears on the remote controller's display.

### Fan-Only Mode

Use the Fan-Only mode to set the system to use only air ventilation and no heating or cooling.

To put the system in Fan-Only mode, press the **MODE** button until the  symbol appears on the remote controller's display.

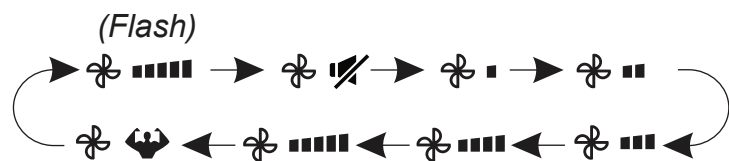

Use the **FAN** button to set the desired fan speed. The system will cycle from **Auto > Mute > Low > Low-Mid > Mid > Mid-High > High > Turbo**



### Auto Mode

In Auto mode, the system selects either Cooling, Heating, or Fan-Only mode based on the delta-T ( $\Delta T$ ), which is the difference between the room temperature and set temperature.

$\Delta T$ (RT-ST)	$\Delta T > 2^\circ F$	$-2^\circ F \leq \Delta T \leq 2^\circ F$	$\Delta T < 2^\circ F$
<b>→MODE</b>	Cooling	Fan-Only	Heating

To put the system in Auto mode, press the **MODE** button until the  symbol appears on the remote controller's display. Use the  and  buttons to set the desired room temperature.

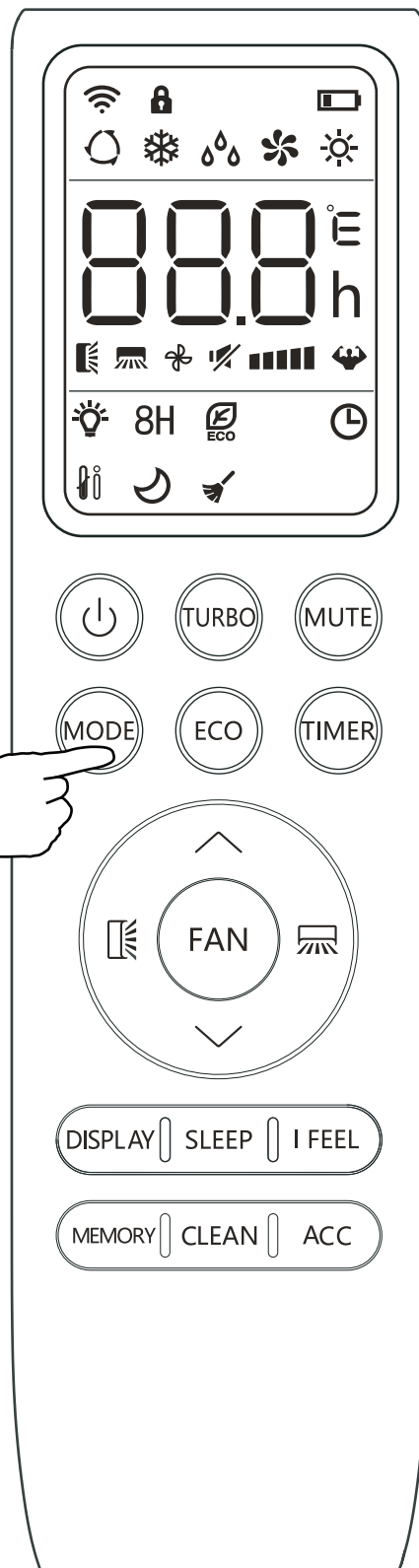

# Operating Instructions

# 5

## Turn the Display On or Off

The LED display on the front panel of the system can be turned on or off as desired.

Press the **DISPLAY** button in order to switch off the LED display on the front panel. Press the button again to turn the LED display back on.

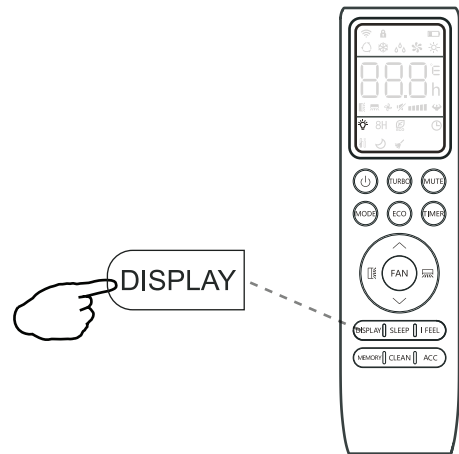

## Sleep Mode

Sleep mode is generally meant for periods of lesser cooling/heating requirements, such as during typical sleeping hours. This mode will decrease energy use. The mode can be activated via the remote controller and wired thermostat.

After 10 hours in Sleep mode, the air conditioner will revert back to the previously set mode.

Press the **SLEEP** button and the  symbol will appear on the display. Press this button again to exit from this mode.

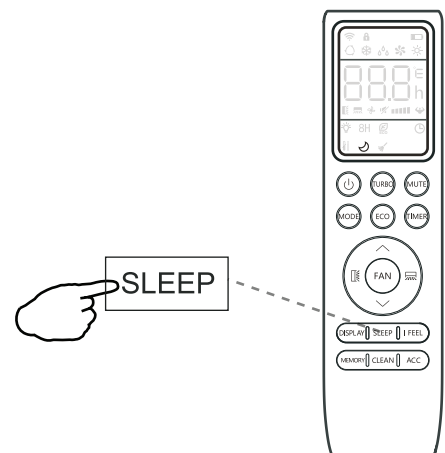

## I Feel - To Ensure Comfort

The I Feel feature enables the remote controller to act as the temperature sensor and relay the current air temperature of where the controller is physically placed within the room. In some cases, this can aid with reducing thermal drift between the set temperature and the actual room temperature.

In order to activate this feature, press the **I FEEL** button and the  icon will appear on the display.

### Note

The I Feel feature will automatically deactivate itself 8 hours later (or 2 hours on some models).

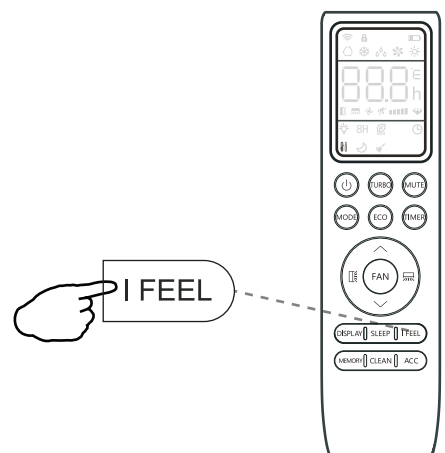



# Operating Instructions

# 5

## Energy Saver (ECO) Option

In this mode, the appliance will automatically manage its operation in order to save energy.

To turn the ECO feature on, press the  button on the remote controller and the  icon will appear. The system is now running in ECO mode. The process can be repeated to turn it off.

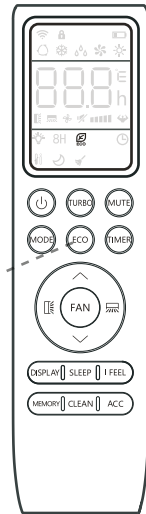

### Note

The ECO feature is available in both Cooling and Heating mode.





## Turbo Option

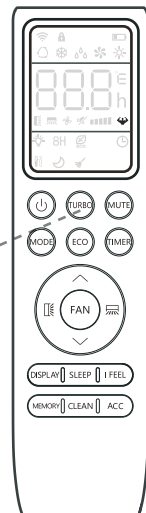
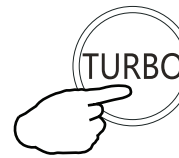

In this mode, the appliance will operate using the highest fan speed in order to maximize output and reach the set temperature in the quickest way.

To turn the Turbo feature on, press the  button on the remote controller and the  icon will appear. The system is now running in Turbo mode. Repeat the process to turn off the feature.



## Child-Lock Function

Press the  and  buttons together to activate the child-lock function. When this function is turned on, the  icon will display and no single button will be active.

Press the  and  buttons together once more to deactivate the child-lock function.

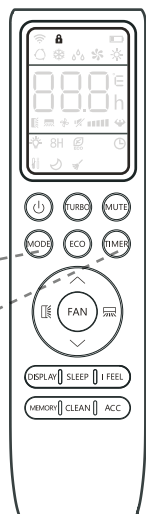
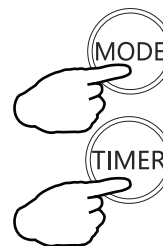









# Operating Instructions

# 5

## Use the Timer - Timer On

The Timer feature allows the user to set a time delay for the system to turn itself on or off.



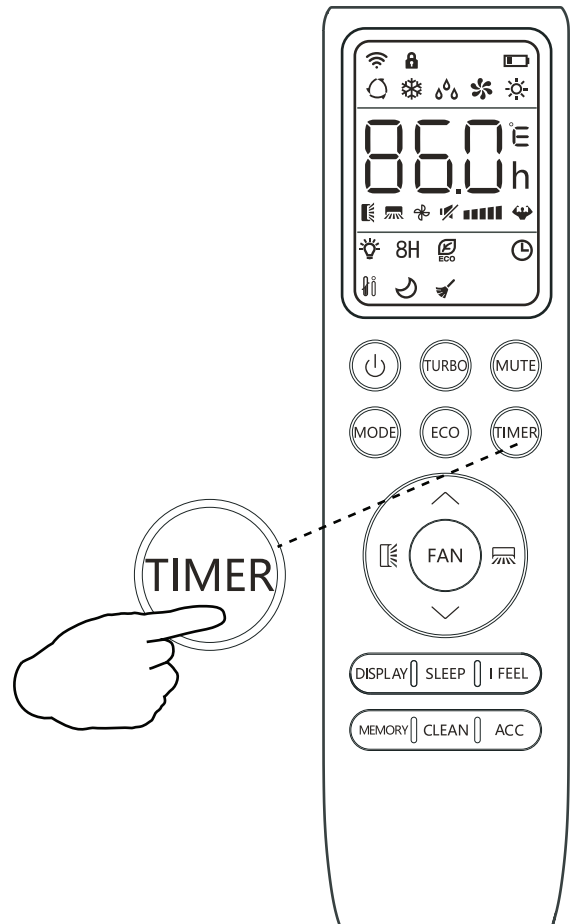

To set a timer for the system to turn itself on in a specified amount of hours, follow these steps:

1. Begin by pressing the  button while the system is powered off. The  symbol will then display flashing. The default setting is 6 hours.
2. Use the  and  buttons to set the needed time delay in 30 minutes increments.
3. Press the  button a second time to confirm.
4. Press the  button to select the desired operating mode that the unit should start up in.
5. Press the  button to set the desired fan speed that the unit should start up in.
6. Use the  and  buttons to set the desired operation temperature. The unit is now primed.



## Use the Timer - Timer Off

The Timer Off feature allows the appliance to turn itself off after a determined amount of hours have passed. The symbol  will appear. To set a timer for the system to turn itself off in a specified amount of hours, follow these steps:

1. Confirm that the appliance is on and running.
2. Press the  button to enter the prompt for switching off the system. Use the  and  buttons to configure the time delay setting.
3. Press the  button again to confirm. Press it once more to cancel the setting.

### Note Regarding Timers

- Press the  button to cancel at any time in Timer Off.
- The programming will cancel if no buttons are pressed after 5 seconds. This may require restarting the process.

# Operating Instructions

# 5

## 46°F Freeze Protection Function

Use this feature to prevent freezing while the user is away from home. When turned on, it sets the system to maintain a temperature of 46°F (8°C). If the unit is in standby, the setting will automatically start the Heating mode when the room temperature is equal to or lower than 46°F (8°C). The feature will set the system back to standby when the room temperature reaches 48°F (9°C).

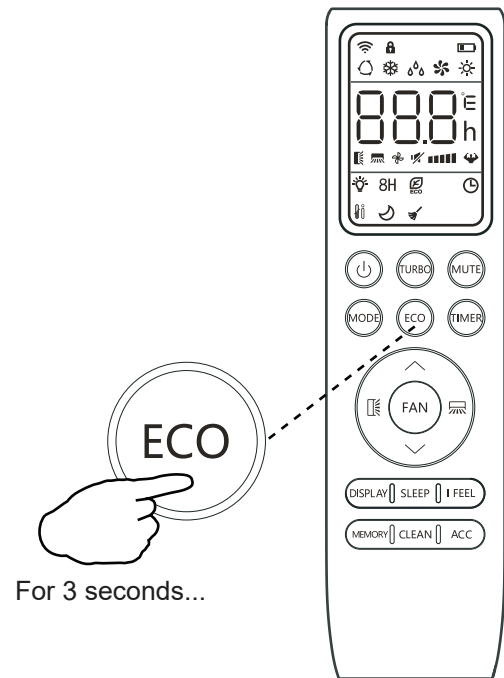

If the room temperature is ever 64°F (18°C) or higher, then the appliance will cancel or prevent this feature automatically.

Press and hold the  button for 3 seconds to activate this feature. Repeat this to deactivate the feature. Once activated, 46°F (8°C) will appear on the display.



## Mute Mode

When the system is muted, the remote controller will display the auto fan speed and the indoor unit will operate at its lowest fan speed in order to minimize operation noise.

Press the  button in order to activate this mode. The  icon will display to indicate that the system is muted.

Press either the Fan, Turbo, or Sleep button to cancel this mode.

### Note:

The Mute feature cannot be activated when the system is in Dry mode.

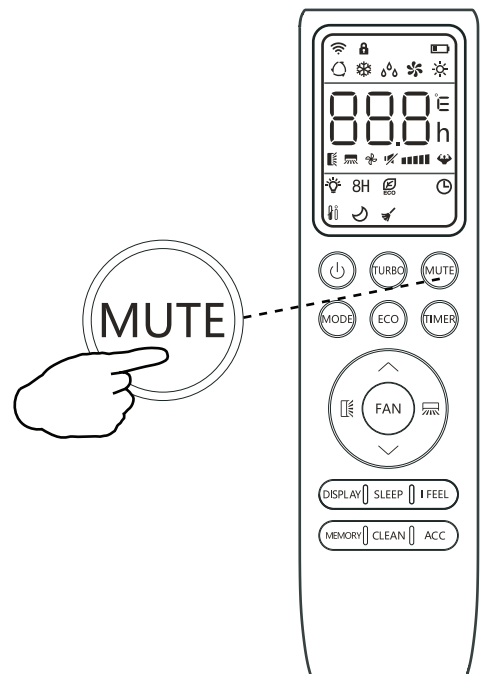

# Operating Instructions

# 5

## Memory Feature

The Memory feature enables the user to store their favorite settings and reconfigure the system to the same parameters with the press of a single button. Each mode (Heat / Cool / Fan / Dry) can store a unique setting.

To use this feature, enter the desired mode and set the system to the preferred configuration. Press and hold the **MEMORY** button for 3 seconds to store the configuration. The system will flash "AU" to acknowledge that the configuration has been stored successfully.

Enter the desired mode (Heat / Cool / Fan / Dry) and press the **MEMORY** button to activate the stored configuration.

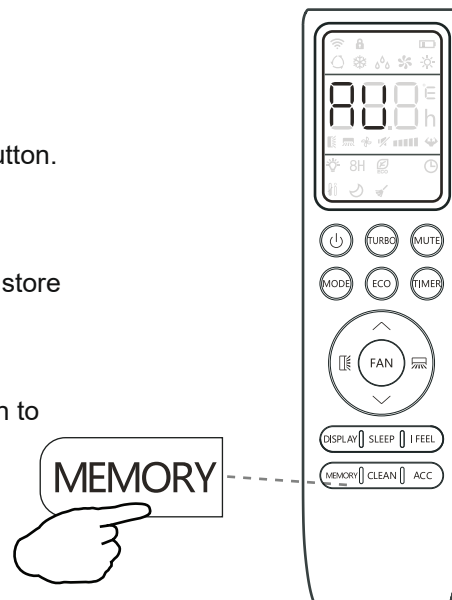

## Self-Clean Feature

This feature helps remove some of the accumulated dust, dirt, bacteria, and other microbial contents from the indoor evaporator.

To activate this feature, press the **CLEAN** button until a beep is heard from the unit. The  icon and AC displays on the unit and remote controller. This procedure will operate for approximately 30 minutes before returning to the preset mode.

Press the  button to cancel this feature during the process. Two beeps will be emitted from the machine when it is finished or canceled.

This procedure can result in some uncommon noise coming from the machine. This noise is normal as a side effect of the plastics expanding and contracting due to reactions with heat and cold.

Only use this function when the indoor temperature is under 86°F (30°C) and outside temperature is between 41-68°F (5-20°C).

It is suggested to run this feature once every 3 months.

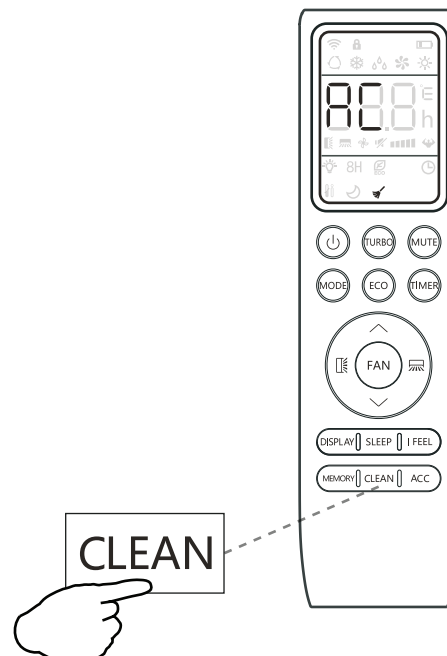

### **Note:**

This feature does not replace the requirement of proper periodic maintenance and cleaning, especially for dusty/high-particle environments.

# Operating Instructions

# 5

## Important Note Regarding Operating Temperatures

The system is designed to run within a certain range of temperatures, which are listed below. The system has built-in protections that may stop the appliance when the ambient temperatures goes outside of these ranges.

### Inverter Air Conditioner

Operating Mode Temperature	Cooling Mode	Heating Mode	Drying Mode
<b>Operational Room Temperature Range</b>	63-90°F (17-32°C)	32-80°F (0-27°C)	63-90°F (17-32°C)
<b>Remote Control Setting Range</b>	61-86°F / 16-30°C (Standard Setting Range) 46°F / 8°C (Vacation Mode Only; See page 18)		
<b>Ambient Outdoor Temperature</b>	5-122°F (-15-50°C)	-13-86°F (-25-30°C)	5-122°F (-15-50°C)

### Note

The system will restart after a 3-minute delay if you stop and restart the air conditioner or change its mode (as protection for the compressor).

Testing and rating agencies develop standard rating conditions to obtain full system-rated capacity and efficiency. Within certain limitations, variable speed compressors compensate the deviations from the rating conditions, especially the atmospheric conditions.

Heat pump systems function by exchanging energy between the indoor air and outdoor ambient air (atmospheric) in the form of heat. The system's net cooling or heating capacities and efficiencies change by atmospheric conditions, as well as the indoor air conditions, such as temperatures and humidity levels.

Professional individuals determine the capacity of the system required for a specific area or application using detailed calculations, which are based on several internal and external factors.

### To further optimize the performance of the unit, complete the following:

- Keep doors and windows closed.
- Use Timer On and Timer Off functions to limit energy usage.
- Do not block air inlets or outlets.
- Regularly inspect and clean air filters.

# Maintenance

# 6

## Periodic Maintenance is Essential for the System!

Maintaining the air conditioner will ensure that the system stays efficient. Before carrying out any sort of maintenance, ensure that the power supply to the system is turned off for more than 5 minutes. Wear safety gloves when working on the equipment, due to sharp aluminum fin edges of the coil.

### Indoor Unit

1. Approach the interior unit to reach the filter area, and unlatch the grille to swivel outward.
2. Gently remove the single anti-dust filter along with the panel grill by sliding it out to the side.
3. Clean the filters with warm water (under 113°F / 45°C).  
**Note:** The filters are washable.
4. Leave the filters to dry in a cool, dry place.
5. After, re-insert the filter into the same location after it has sufficiently dried.

**Note:** Accessorial electrostatic or deodorizing filters are not washable and should be replaced every 6 months.

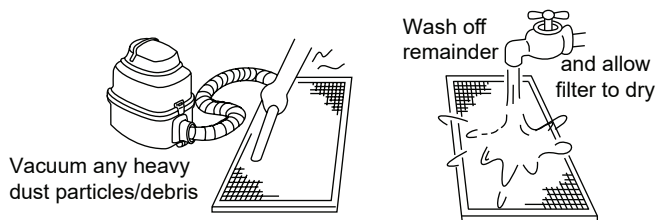
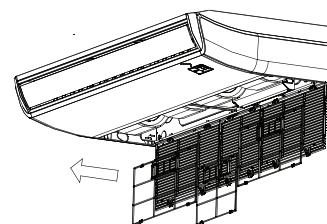
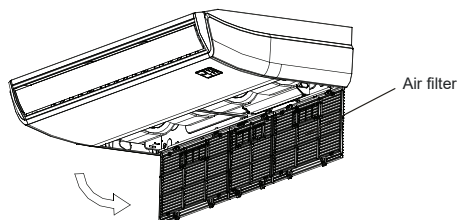
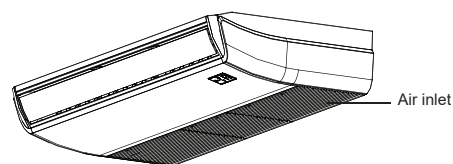

### Interior of the Indoor Air Handler

In addition to the filters, inspect the interior of the indoor unit as well as the inner coil every season. Disconnect the front panel and remove the top hinge where the pegs connect. This will offer easier inspections of the interior and behind the air filters. Clean the interior with a damp cloth and neutral soaps. Do not use any types of aggressive solvents or detergents. Only use a soft cloth that is lightly damp.

#### **⚠ Before Cleaning or Maintenance**

Always turn off the air conditioner system and disconnect its power supply before cleaning or performing maintenance. Do not spray water directly near the indoor unit, as it can damage insulation and electrical components.

# A2L Refrigerants

# 7

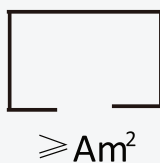

# A2L



## Safety Information for A2L Refrigerants

Because the system contains R-454B refrigerant, read and observe the following notices. Venting any type of refrigerant into the atmosphere is always illegal and punishable under federal and local regulations. Always read and obey all applicable local EPA laws.

- Refer to this manual for the required installation space dimensions, including the minimum clearance distances from adjacent structures.
  - Install, operate, and store the appliance in a room following the minimum room area requirements (See page 31).
  - Keep the length of the refrigerant piping to a minimum.
  - Protect the refrigerant piping from physical damage. In addition, if the area of the space is smaller than the minimum, ensure the installation occurs in a ventilated space.
  - Ensure the installation complies with all applicable national refrigerant regulations.
  - Ensure all mechanical connections remain accessible for maintenance.
  - Follow the instructions in this manual for proper handling, installation, cleaning, maintenance, and disposal of the refrigerant.
  - Confirm that all ventilation openings remain unobstructed.
- ⚠ Perform the servicing only in accordance with the manufacturer's recommendations.
  - ⚠ Store the appliance in a well-ventilated area with a room size that meets the minimum requirements specified for operation.
  - ⚠ Store the appliance in a room free of continuously operating open flames (e.g., an active gas appliance) and ignition sources (e.g., an operating electric heater).
  - Individuals working on refrigerant circuits must hold a valid, up-to-date certification from an industry-accredited assessment authority. They must verify their competence in handling refrigerants per the recognized assessment specifications of the relevant industrial sector.
  - Perform service operations strictly in accordance with the manufacturer's recommendations.
  - If maintenance and repairs require assistance from additional qualified personnel, conduct the tasks under the supervision of a certified professional competent in handling flammable refrigerants.

# A2L Refrigerants

# 7

## Service Information for A2L Refrigerants

- Store the appliance in a manner that prevents mechanical damage.
- Competent personnel must carry out any work procedures affecting safety measures.

### **Warning**

- Do not attempt to accelerate the defrosting process or remove frost manually.
- Follow the manufacturer's recommended procedures.
- Store the appliance in a room free of continuously operating ignition sources (e.g., open flames, active gas appliances, operating electric heaters).
- Do not pierce or incinerate the appliance or its components.
- Be aware that refrigerants may be odorless.
- **Area Inspection:**
  - Before servicing systems containing flammable refrigerants, perform safety checks to minimize the risk of ignition. When repairing the refrigeration system, observe all the following precautions before beginning any work.
- **Work Procedure:**
  - Conduct all work under a controlled process to minimize the risk of flammable gas or vapor from being present during service.
- **General Work Area:**
  - Inform all maintenance personnel and individuals in the vicinity about the nature of the work being performed.
  - Avoid working in confined spaces whenever possible.
  - Section off the work area to prevent unauthorized access.
- **Area Ventilation:**
  - Ensure that the area is free from flammable materials and conditions are controlled to maintain a safe working environment.
- **Checking for Refrigerant Presence:**
  - Monitor the work area for refrigerant leaks using an appropriate refrigerant detector before and during service.
  - Ensure the leak detection equipment used is suitable for flammable refrigerants (i.e., non-sparking, adequately sealed, or intrinsically safe).
- **Presence of Fire Extinguisher:**
  - If performing any hot work on the refrigeration equipment or its associated components, ensure appropriate fire extinguishing equipment is readily available. Position a dry powder or CO<sub>2</sub> fire extinguisher adjacent to the charging area.
- **Elimination of Ignition Sources:**
  - Do not use ignition sources that could pose a fire or explosion risk when conducting any work involving the exposure of refrigeration system piping.
  - Keep all potential ignition sources, including smoking, at a safe distance from the installation, repair, removal, disposal areas, and locations where refrigerant may be released unintentionally into the surrounding space.
  - Before commencing work, inspect the area to ensure that no flammable hazards or ignition risks are present.
  - Clearly display "No Smoking" signs in the work area.

# A2L Refrigerants

# 7

## Service Information for A2L Refrigerants (Continued)

- **Ventilated Area:**

- Ensure the work is conducted in either an open area or in a space with adequate ventilation before breaking into the system or performing any heat-producing tasks.
- Maintain ventilation throughout the duration of the work.
- Ensure the ventilation system effectively disperses any released refrigerant and directs it safely to an external atmosphere, if possible.

- **Inspection of Refrigeration Equipment:**

- When replacing electrical components, ensure that they meet the correct specifications and are suitable for its intended purpose.
- Follow the manufacturer's maintenance and service guidelines.
- If unsure, consult the manufacturer's technical support department for guidance.

- **Inspections for Installations Using Flammable Refrigerants:** Perform the following inspections for systems utilizing flammable refrigerants:

- Ensure that the refrigerant charge size complies with the minimum room size requirements when installing refrigerant-containing components.
- Verify that the ventilation equipment and exhaust outlets are functioning properly and free from obstructions.
- If using an indirect refrigerant circuit, inspect the secondary circuit for any presence of refrigerant.
- Confirm that all equipment markings remain visible and legible. Replace or correct any illegible markings or signs.

- Install the refrigeration piping and components in locations where they are not exposed to substances that could cause corrosion. If exposure is unavoidable, verify that the components are either made from corrosion-resistant materials or are adequately protected against corrosion.

- **Inspection of Electrical Devices:**

- Ensure the repair and maintenance of electrical components include initial safety checks and a thorough inspection of components.
- If the fault cannot be corrected immediately but continuing work is necessary, implement a temporary solution that is safe and effective.
- Report any temporary measures to the equipment owner, ensuring all relevant parties are informed.

- **Initial Safety Checks:**

- Fully discharge the capacitors in a controlled manner to prevent sparking.
- Verify that no live electrical components or exposed wiring are present during system charging, refrigerant recovery, or purging.
- Confirm that the earth bonding continuity is maintained.

- **Repairs to Sealed Components:**

- Replace sealed electrical components, rather than repair them.

- **Repairs to Intrinsically Safe Components:**

- Replace intrinsically safe components, rather than repair them.

# A2L Refrigerants

# 7

## Service Information for A2L Refrigerants (Continued)

- **Cabling:** Do not expose the cabling to wear, corrosion, excessive pressure, vibration, sharp edges, or other adverse environmental factors. Consider the long-term effects of aging and continuous vibration from components such as compressors or fans.
- **Detection of Flammable Refrigerants:** Do not use potential sources of ignition for refrigerant leak detection under any circumstances.
- **Leak Detection Methods:** The following methods are approved for detecting leaks in systems containing flammable refrigerants:
  - **Electronic Leak Detectors:** Use this method for detecting flammable refrigerants. **Note:** They may require recalibration to maintain adequate sensitivity.
    - Calibrate the detection equipment in a refrigerant-free area.
    - Ensure that the detector does not pose an ignition risk and is compatible with the refrigerant in use.
    - Set the detector to a percentage of the refrigerant's Lower Flammability Limit (LFL). In addition, calibrate the detector to confirm that the appropriate gas concentration does not exceed 25% of the LFL.
  - **Leak Detection Fluids:** This method is suitable for most refrigerants but must not contain chlorine. **Note:** Chlorine can react with the refrigerant and corrode copper piping.
  - **Safety Precautions:** If a leak is suspected, remove or extinguish all open flames. If a refrigerant leak requiring brazing is detected, fully recover the refrigerant or isolate the refrigerant using the shut-off valves to prevent accidental release.
  - **Oxygen-Free Nitrogen:** Purge oxygen-free nitrogen through the system before and during brazing.
- **Removal and Evacuation:** When accessing the refrigerant circuit for repairs or other procedures, follow the industry-standard practices, with additional precautions for flammability:
  1. Recover the refrigerant into approved recovery cylinders.
  2. Purge the circuit using an inert gas, such as OFN.
  3. Evacuate the system.
  4. Purge the circuit again using inert gas.
  5. Open the circuit by cutting or brazing.
    - Flush the system with OFN to ensure safety. Repeat this process multiple times if needed.
    - Do not use compressed air or oxygen for flushing.
- **Flushing:** Follow this flushing procedure:
  1. Break the system vacuum with OFN.
  2. Fill the system until the working pressure is reached.
  3. Vent the system to atmospheric pressure.
  4. Pull the system down to vacuum.
  5. Repeat this process until no refrigerant remains in the system.
  6. When the final OFN charge is introduced, vent the system to atmospheric pressure to allow for safe work. This step is critical before performing any brazing on pipework.

**Note:** Position the vacuum pump outlet away from ignition sources and ensure adequate ventilation.

# A2L Refrigerants

# 7

## Decommissioning Information for A2L Refrigerants

**Decommissioning:** Before starting the decommission process, the technician must be fully familiar with the equipment and its components. Safely recover all refrigerant as a standard best practice. Prior to decommissioning, collect an oil and refrigerant sample for analysis if reclaimed refrigerant is intended for reuse. Ensure electrical power is available before beginning the decommissioning process.

**A. Familiarization:** Understand the equipment, its operation, and the decommissioning process before beginning work.

**B. Electrical Isolation:** Disconnect the system from the electrical supply to prevent accidental activation during the procedure.

**C. Pre-Procedure Safety Checks:** Before proceeding, ensure the following:

- Mechanical handling equipment is available if needed for refrigerant cylinder transport.
- All required personal protective equipment (PPE) is present and correctly used.
- A competent person supervises the entire refrigerant recovery process.
- Recovery equipment and cylinders comply with all relevant safety and regulatory standards.

**D. Pump Down the Refrigerant System:** If possible, perform a pump-down procedure to remove refrigerant from the system.

**E. Alternative Method if Vacuum is Not Possible:**

If a complete vacuum cannot be achieved, create a manifold to facilitate refrigerant removal from multiple points in the system.

**F. Cylinder Positioning:** Ensure the recovery cylinder is placed on a scale before starting the refrigerant recovery process.

**G. Recovery Machine Operation:** Start the recovery machine and follow the manufacturer's instructions for proper operation.

**H. Cylinder Fill Limits:** Do not exceed 80% of the cylinder's total volume when filling with liquid refrigerant, allowing expansion.

**I. Maximum Pressure Precautions:** Do not exceed the maximum working pressure of the recovery cylinder at any time, even temporarily.

**J. Finalizing the Recovery Process:**

Once the cylinders are correctly filled and the process is complete:

- Promptly remove the cylinders and recovery equipment from the site.
- Close all isolation valves on the equipment to prevent leaks.

**K. Handling Recovered Refrigerant:** Recovered refrigerant must not be recharged into another refrigeration system unless it has been properly cleaned and tested to ensure compliance with safety and performance standards.

**L. Labeling:** Label the equipment indicating that it has been decommissioned and emptied of refrigerant. The label must include the decommissioning date and signature of the responsible technician. Ensure that the equipment preserves labels indicating the presence of flammable refrigerant, even after decommission.

# A2L Refrigerants

# 7

## **Recovery Information for A2L Refrigerants**

**Recovery Procedure:** When removing refrigerant from a system for servicing or decommissioning, observe the following best practices to ensure safety and compliance:

**1. Safe Refrigerant Removal:** Safely remove all refrigerants from the system following proper handling procedures.

**2. Use of Appropriate Recovery Cylinders:** Only use approved refrigerant recovery cylinders.

- Ensure that a sufficient number of cylinders are available to accommodate the total refrigerant charge from the system.
- Designate and label each cylinder for the specific refrigerant being recovered. (e.g., cylinders specifically designed for refrigerant recovery).
- Equip recovery cylinders with a pressure-relief valve and functioning shut-off valves.
- Evacuate empty recovery cylinders. If possible, pre-cool the recovery cylinders before the process begins.

**3. Recovery Equipment Requirements:** The recovery equipment must be:

- In good working condition.
- Accompanied by manufacturer-provided operating instructions.
- Suitable for recovering all appropriate refrigerants, including flammable refrigerants when applicable.
- Ensure a calibrated weighing scale is available to monitor refrigerant recovery accurately.
- Equip hoses with leak-free disconnect couplings and ensure they're in good conditions.
  - Before using the recovery machine, verify that it is in proper working order and has been properly maintained.
  - Ensure that any associated electrical components are sealed to prevent ignition in case of a refrigerant leak.
  - If in doubt, consult the manufacturer.

**4. Handling Recovered Refrigerant:**

It is vital to:

- Return the recovered refrigerant to the refrigerant supplier in the correct recovery cylinder.
- Arrange a waste transfer note for proper documentation and disposal.
- Do not mix refrigerants in recovery units or cylinders under any circumstances.

**5. Compressor and Oil Removal:**

If compressors or compressor oils need to be removed:

- Evacuate the compressor to an acceptable level to eliminate any remaining flammable refrigerant within the lubricant.
- Complete the evacuation process before returning the compressor to the supplier.
- Only use electric heating to accelerate the evacuation of refrigerant from the compressor body. Do not use open flames or ignition sources.
- When draining oil from a system, conduct the process safely and in accordance with best practices.

# A2L Refrigerants

# 7

## WARNING

- Do not use unauthorized methods to complete cleaning or accelerate defrosting. Follow only the manufacturer's recommended procedures.
- Store the appliance in a room free of continuously operating ignition sources (e.g. open flames, operating gas appliance, electric heater).
- Do not pierce or burn any part of the system.

## AVERTISSEMENT

- Ne pas utiliser de moyens non recommandés par le fabricant pour accélérer le dégivrage ou nettoyer l'appareil.
- L'appareil doit être entreposé dans un endroit sans source d'allumage fonctionnant en continu (par exemple: flamme nue, appareil à gaz en marche, ou radiateur électrique en marche).
- Ne pas percer ni brûler l'appareil.
- Attention: les frigorigènes peuvent être inodores.

## COMPLIANCE

- **Minimum Installation Requirements:** Install the equipment within the minimum height and room area (for both operation and storage) specified in the installation manual.
- **Risk of Fire - Auxiliary Devices:** Do not install ignition source auxiliary devices within the ductwork, unless they are specifically listed for this appliance. Refer to the installation instructions.
- **Mounting Clearance:** Mount the system with the lowest moving parts at least 8 feet (2.5 m) above the floor or grade level.
- **Risk of Electric Shock:** Serious injury or death may occur. Disconnect all remote electric power supplies before performing any service.
- **Risk of Fire - Flammable Refrigerant:** Flammable refrigerant is used. Ensure proper handling and disposal. Trained service personnel must perform maintenance and repairs. Do not puncture the refrigerant tubing.
- **Risk of Fire - Proper Disposal Required:** Dispose of the system according to all applicable federal and local regulations.
- **Risk of Fire - Service Precautions:** Flammable refrigerant is used. Refer to the service manual before attempting to service this product.
- **Risk of Fire - Compliance with Regulations:** Follow all handling instructions and comply with national regulations when working with flammable refrigerants.

## USAGE STATEMENT

- Use a flammable gas detector to check for potential leaks before unloading and opening the container.
- Do not allow fire sources or smoking in the vicinity.
- Protect the pipework from physical damage. For flammable refrigerants, do not install pipes in an unventilated space if it is smaller than the minimum requirements in Annex GG. For A2L refrigerants, you must install pipes that comply with 22.116. If field charging is necessary, technicians must quantify the impact of different pipe lengths on the refrigerant charge.
- Ensure the compliance of all national gas regulations.
- Ensure that mechanical connections made in accordance with 22.118 remain accessible for maintenance.
- Protect pipework, including piping material, routing, and installation from physical damage during operation and servicing. It must comply with all national and local codes and standards, including:
  - ASHRAE 15
  - ASHRAE 15.2
  - IAPMO Uniform Mechanical Code
  - ICC International Mechanical Code
  - CSA B52
  - All field joints must be accessible for inspection before being covered or enclosed.
- After completing the field piping installation for split systems, the field pipework must undergo:
  - Pressure testing with an inert gas.
  - Vacuum testing before refrigerant charging, following the required standards.
- Store the appliance in a way that prevents mechanical damage.
- Qualified personnel must carry out maintenance, service, and repair operations according to Annex HH.
- Only competent individuals should perform safety-critical procedures, including:
  - Breaking into the refrigerant circuit
  - Opening sealed components
  - Opening ventilated enclosures

# A2L Refrigerants

# 7

## Preparation for Working on Systems with A2L Refrigerants



No flammable sources



Ventilation necessary



Wear protective gear



Do not use electronics near system



### Refrigerant Leakage Detector

A handheld leak detector can aid with tracing and isolating refrigerant leaks. It is recommended to have one handy whenever working on the system.

### ! Determining Installation Location

Install the systems in suitable locations according to the guidelines below. For the best results, follow all the requirements for equipment placement in this manual.

## Installation Site Requirements

### 1. Ensure Proper Ventilation

- Ventilate the installation site well to allow safe operation and prevent refrigerant accumulation.

### 2. Keep Away from Heat and Fire Hazards

- Keep all installation and maintenance sites for air conditioners that use R-454B refrigerant away from open flames or heat sources.
- To prevent ignition risks, technicians must avoid locations near welding activities, smoking areas, drying ovens, or any heat source exceeding 1,000°F (538°C).

### 3. Implement Anti-Static Precautions

- Wear anti-static clothing and gloves to prevent static discharge when handling and installing the unit.

### 4. Select an Accessible Installation Site

- The installation location must allow easy access for maintenance.
- Do not surround indoor and outdoor units with obstacles that restrict airflow.
- Keep away from heat sources and flammable or explosive materials.

### 5. Refrigerant Leak Emergency Actions

- If the indoor unit leaks refrigerant during installation, immediately shut off the outdoor unit valve.
- All personnel must evacuate the area for at least 15 minutes until the refrigerant fully dissipates.
- If the product is damaged, transport it to a maintenance station. **Note:** On-site welding or refrigerant pipe repairs are strictly prohibited.

### 6. Ensure Even Airflow

- Choose a location where the indoor unit's air inlet and outlet flow remain unobstructed and evenly distributed.

### 7. Avoid Installing Near Sensitive Areas

- Do not install the indoor unit near:
  - Electric devices or power outlets.
  - Kitchen cabinets, beds, sofas, or valuable items.
  - Areas where the airflow from the two sides of the unit could directly impact important objects.

# A2L Refrigerants

# 7

## Charging Protocol for A2L Refrigerants - If Applicable

### Important Considerations

1. Qualified personnel must install and service the air conditioner. Installers must comply with all instructions set forth herein and all local regulations.
2. Use caution when handling combustible refrigerants. Careless handling can cause serious injury or property damage.
3. Conduct a leak test after completing the installation to ensure system integrity.
4. Conduct safety inspections before performing maintenance or repairs on air conditioners using combustible refrigerants to minimize fire risk.
5. Operate the system under controlled conditions to reduce the risk of combustible gas or vapor hazards.
6. The specifications in Tables GG.1 and GG.2 outline the total weight of refrigerant charge and minimum room area requirements for air conditioners.

**Maximum Refrigerant Charge and Required Floor Area:** The maximum charge is determined by the following equations:

$$m_1 = (6m^3) \times \text{LFL}, m_2 = (52m^3) \times \text{LFL}, m_3 = (260m^3) \times \text{LFL}$$

Where LFL is the lower refrigerant limit in kg/m<sup>3</sup>.

For R-454B refrigerant, LFL = 0.303 kg/m<sup>3</sup>.

For appliances with a charge amount  $m_1 < M = m_2$ :

The maximum refrigerant charge in a room must comply with:  $M_{\max} = 2.5 \times (\text{LFL})^{5/4} \times h_0 \times A^{1/2}$

This value must not exceed:  $M_{\max} = \text{SF} \times \text{LFL} \times h_0 \times A$

(Refer to GG.3DV for specific factors and applications.)

**Minimum Floor Area Requirement:** The required minimum floor area  $A_{\min}$  for an appliance with a refrigerant charge  $M_c$  (kg) must be calculated as follows:

$$A_{\min} = [M_c / (2.5 \times \text{LFL}^{5/4} \times h_0)]^2$$

However,  $A_{\min} = M_c / (\text{SF} \times \text{LFL} \times h_0)$ ; SF = 0.5

Refer to GG.4DV for specific values/factors.

Where Category = R-454B, LFL = 0.303 kg/m<sup>3</sup>

**Table GG.1 - Maximum Charge (kg)**

$h_0$ (m)	Floor Area (m <sup>2</sup> )	Charge Limit (kg)
1.8 (6'0")	4 (43 ft <sup>2</sup> )	1.09 (38.5 oz)
	7 (75 ft <sup>2</sup> )	1.91 (67.3 oz)
	10 (107 ft <sup>2</sup> )	2.73 (96.2 oz)
	15 (161 ft <sup>2</sup> )	3.92 (138.2 oz)
	20 (215 ft <sup>2</sup> )	4.52 (159.6 oz)
	30 (322 ft <sup>2</sup> )	5.54 (195.5 oz)
	50 (538 ft <sup>2</sup> )	7.15 (252.3 oz)
2.5 (8'2")	4 (43 ft <sup>2</sup> )	1.52 (53.44 oz)
	7 (75 ft <sup>2</sup> )	2.65 (93.5 oz)
	10 (107 ft <sup>2</sup> )	3.79 (133.6 oz)
	15 (161 ft <sup>2</sup> )	5.44 (191.9 oz)
	20 (215 ft <sup>2</sup> )	6.28 (221.6 oz)
	30 (322 ft <sup>2</sup> )	7.7 (271.4 oz)
	50 (538 ft <sup>2</sup> )	9.94 (350.4 oz)
2.8 (9'2")	4 (43 ft <sup>2</sup> )	1.7 (59.8 oz)
	7 (75 ft <sup>2</sup> )	2.97 (104.7 oz)
	10 (107 ft <sup>2</sup> )	4.24 (149.6 oz)
	15 (161 ft <sup>2</sup> )	6.09 (215 oz)
	20 (215 ft <sup>2</sup> )	7.04 (248.2 oz)
	30 (322 ft <sup>2</sup> )	8.62 (304 oz)
	50 (538 ft <sup>2</sup> )	11.12 (392.5 oz)

# A2L Refrigerants

# 7

## Charging Protocol for A2L Refrigerants - If Applicable (Continued)

Where Category = R-454B, LFL = 0.303 kg/m<sup>3</sup>

**Table GG.2 - Minimum Room Area (m<sup>2</sup>)**

h <sub>0</sub> (m)	Charge Limit (kg)	Min. Room Area (m <sup>2</sup> )
(Installed Height)	0.71 (25.1 oz)	2.6 (28 ft <sup>2</sup> )
	0.8 (28.2 oz)	2.93 (32 ft <sup>2</sup> )
1.8 (6'0")	1.0 (35.3 oz)	3.67 (40 ft <sup>2</sup> )
	1.29 (45.5 oz)	4.73 (51 ft <sup>2</sup> )
	1.56 (55 oz)	5.72 (62 ft <sup>2</sup> )
	1.8 (63.5 oz)	6.6 (71 ft <sup>2</sup> )
	2.0 (70.5 oz)	7.33 (79 ft <sup>2</sup> )
2.5 (8'2")	0.71 (25.1 oz)	1.88 (21 ft <sup>2</sup> )
	0.8 (28.2 oz)	2.11 (23 ft <sup>2</sup> )
	1.0 (35.3 oz)	2.64 (29 ft <sup>2</sup> )
	1.29 (45.5 oz)	3.41 (37 ft <sup>2</sup> )
	1.56 (55 oz)	4.12 (45 ft <sup>2</sup> )
	1.8 (63.5 oz)	4.75 (52 ft <sup>2</sup> )
2.8 (9'2")	2.0 (70.5 oz)	5.28 (57 ft <sup>2</sup> )
	0.71 (25.1 oz)	1.67 (19 ft <sup>2</sup> )
	0.8 (28.2 oz)	1.89 (21 ft <sup>2</sup> )
	1.0 (35.3 oz)	2.36 (26 ft <sup>2</sup> )
	1.29 (45.5 oz)	3.04 (33 ft <sup>2</sup> )
	1.56 (55 oz)	3.68 (40 ft <sup>2</sup> )
	1.8 (63.5 oz)	4.24 (46 ft <sup>2</sup> )
2.0 (70.5 oz)	4.71 (51 ft <sup>2</sup> )	

The standard factory refrigerant charge amount as well as the maximum allowable charge are as follows:

**Table GG.3DV - Maximum Charge (g) [lbs]**

Model (BTU)	R-454B Refrigerant (Standard Charge)	R-454B Refrigerant (Maximum Charge)
18,000	1290 g / 2.84 lbs	1365 g / 3.01 lbs
22,200	1560 g / 3.44 lbs	1635 g / 3.61 lbs

The calculated minimum allowable room area for all capacities is as follows:



















**Table GG.4DV - Minimum Room Area (m<sup>2</sup>)**

Model (BTU)	Minimum Allowable Room Area (Assumes 25 ft lineset and 6 ft install height)
18,000	4.73 m <sup>2</sup> (51 ft <sup>2</sup> )
22,200	5.72 m <sup>2</sup> (62 ft <sup>2</sup> )

### ! Determining Refrigerant Amount

Use the above figures when charging an empty system. The proceeding pages will also inform the reader in determining the additional refrigerant charging amounts for adjusting the factory charge when using non-standard piping length.

### Suggested Tools:

Tool	Illustration	Tool	Illustration	Tool	Illustration
Standard wrench		Pipe cutter		Vacuum pump	
Adjustable / Crescent wrench		Screw drivers (Phillips & Flathead)		Safety glasses	
Torque wrench		Manifold gauge		Work gloves	
Hex keys or Allen wrenches		Level		Refrigerant scale	
Drill & Drill bits		Flaring tool		Micron gauge	
Hole saw		Clamp-on amp meter		Leak detector	

# Indoor Unit Installation Instructions

# 8

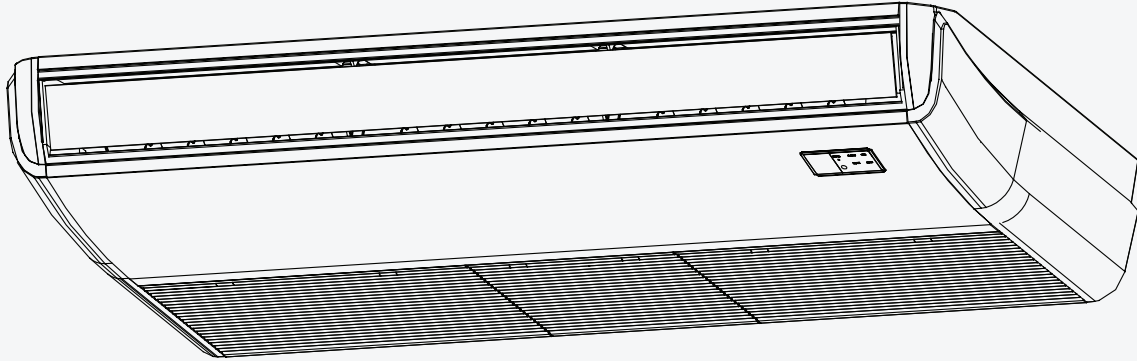

## Indoor Unit Dimensions

Before proceeding, select the installation space according to the below clearances:

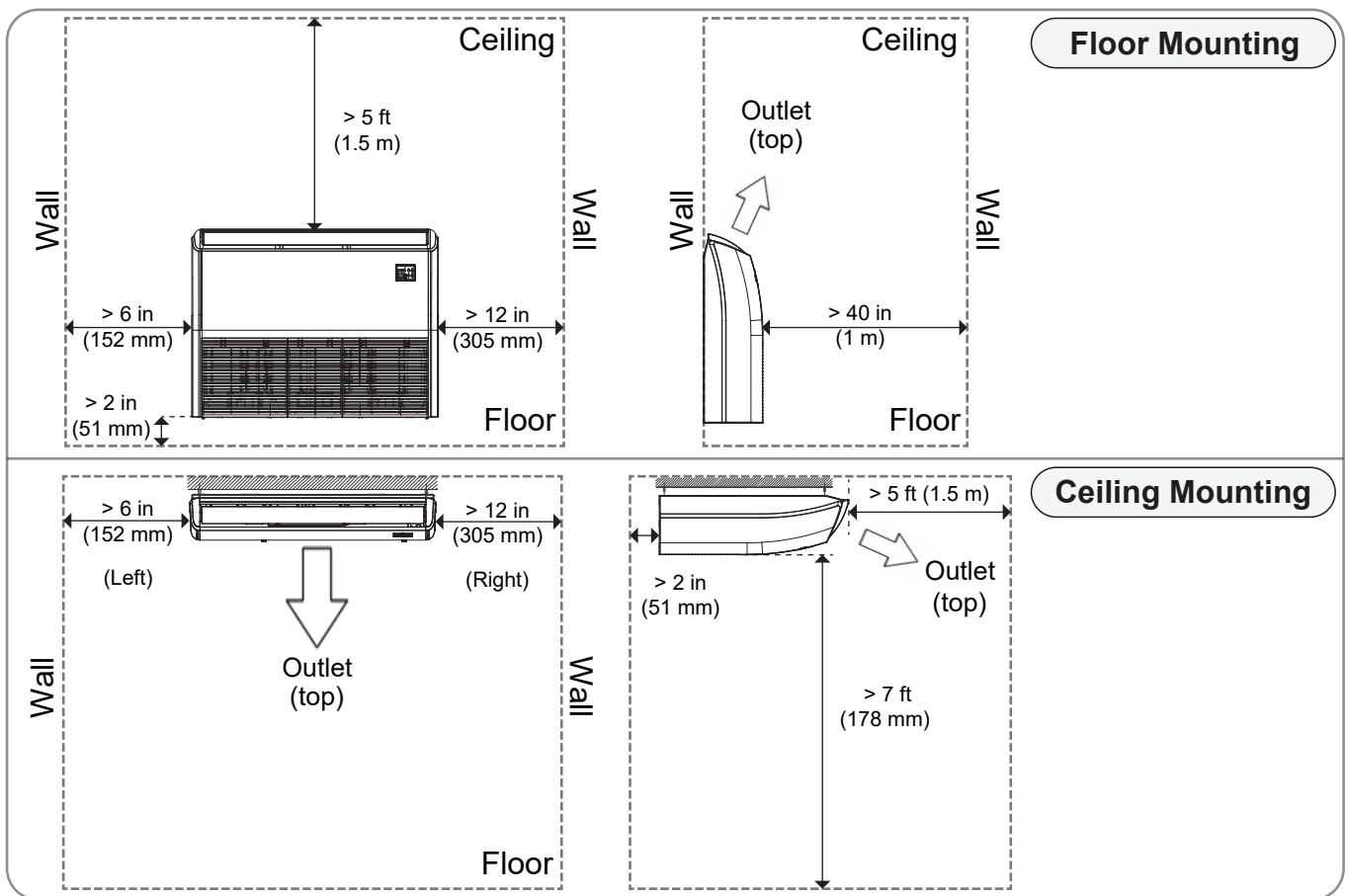

# Indoor Unit Installation Instructions

## 8

### Indoor Unit Installation Location Selection

Follow these site selection guidelines when installing the indoor unit to prevent malfunction, damage, or hazardous conditions. Position the air handler in the center of the area to be conditioned to ensure the best air distribution.

#### **Do Not:**

- Install the unit in areas where flammable gases may accumulate (e.g., fuel storage areas, chemical plants).
- Install in coastal or seaside locations with salty air exposure (unless the system is specially treated for corrosion resistance).
- Install the unit in environments containing caustic gases such as sulfur compounds near hot springs or industrial zones.
- Mount the unit on surfaces that cannot support its full operational weight such as weak ceilings or unstable walls.
- Install the unit in kitchens or areas heavily exposed to oil fumes, vapors, or grease accumulation.
- Install the unit in areas subject to strong electromagnetic interference such as near factories, radio transmitters, and heavy-duty electrical equipment.
- Install near sources of acidic or alkaline vapors, including industrial cleaners or chemical discharge zones.
- Install in tightly enclosed spaces with inadequate ventilation, which may restrict airflow and service access.
- Install in high-humidity spaces such as laundry rooms or bathrooms without sufficient moisture control.
- Neglect proper electrical insulation for the air conditioner-building wiring. Installation must comply with national electrical safety standards.

# Indoor Unit Installation Instructions

# 8

## Indoor Unit Installation Location Selection (Continued)

### Do:

- Select a location protected from direct sunlight to prevent heat buildup and maintain cooling performance.
- Verify that the structural ceiling or wall can support the unit's weight under full operational load.
- Choose an installation site with a short, direct path for the condensation drain, complying with local building codes.
- Allow adequate clearance around the unit to facilitate proper airflow, operation, and maintenance access.
- Position the unit more than 3 feet (1 m) away from antennas, powerlines, telephones, security systems, and other sources of electrical/radio interference.
- Educate the user on proper operation / maintenance procedures, including filter cleaning, basic troubleshooting, and using the provided user manual.

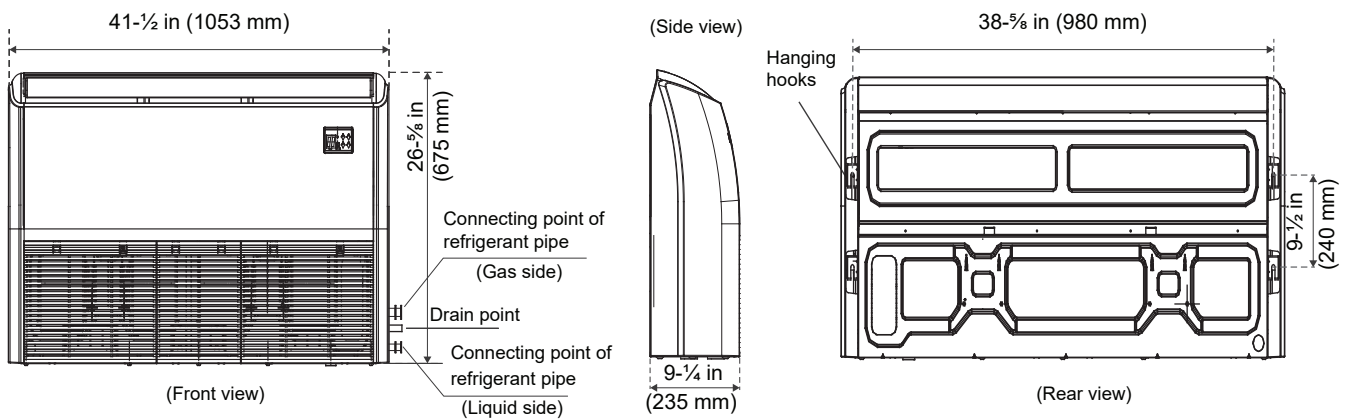

# Indoor Unit Installation Instructions

# 8

## Mounting Procedure - Floor Mounting Applications

### Pre-Installation Preparation

1. Select an installation location that provides unobstructed airflow and adequate access for maintenance. Avoid positioning the unit near obstacles that may restrict air intake or discharge.
2. Mount the air handler to a structurally sound wall that can fully support the unit's weight. The wall surface must be flat and level to allow the unit to sit flush against it. An uneven surface may cause vibration and could result in operational issues or physical damage to the unit.
3. Dislodge and remove both side panels as well as the return grille of the air handler, then set them aside.
4. Select the piping and drainage exit pathway, both the rear side and below side are available.

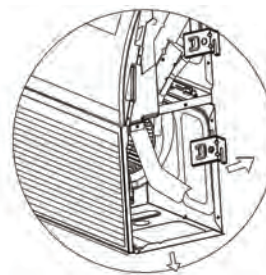

Decide whether the lineset and service bundle will enter from below or behind the unit.

### Hanging Bolt Installation

1. Use 4x field-provided  $\frac{3}{8}$  inch mounting bolts and 8x washers / nuts to suspend the indoor unit.
2. The center-to-center distance between bolts must match the specifications provided for the unit size.
3. Follow the specific installation diagram and measurements provided in this manual to complete the hanging bolt installation.
4. The available mounting methods apply to both ceiling and floor applications.
5. Confirm bolts are properly spaced / perfectly level.
6. Hang the indoor unit onto the mounted bolts.
7. Confirm unit is perfectly level before continuing.

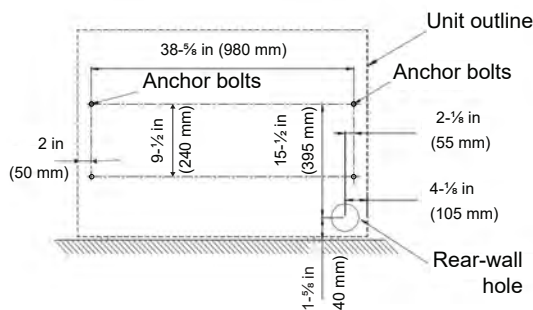

### New Concrete Bricks

- Use one of the following methods to embed the screw bolts:
  - Blade-type insertion
  - Slide-in channel insertion
- Ensure the screw bolts are anchored firmly into embedded steel reinforcement bars.

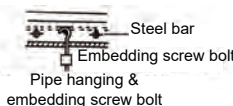

### Ceiling or Wall Structure Mounting Methods

#### Wooden Construction

- Secure angle iron across the wooden joists.
- Secure the hanging screw bolts through the channel and into the ceiling structure below.

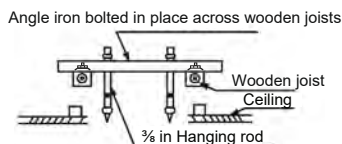

#### Finished Concrete (Brick or Slab)

- Use expansion bolts to fix the hanging hooks directly into the concrete.
- Drill to a depth of 45-50 mm to ensure secure anchoring.

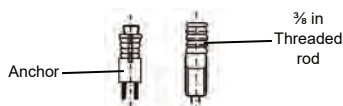

#### Steel Roof Beam Structure

- Install supporting angle steel brackets.
- Mount the hanging bolts through the brackets and secure as shown in the illustration.

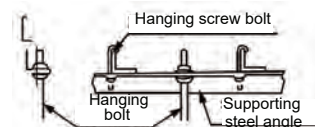

# Indoor Unit Installation Instructions

# 8

## Mounting Procedure - Ceiling Mounting Applications

The installation preparation for mounting to the ceiling is identical for floor-mounting steps 1-3 (page 34). Step 4 differs because the rear exit (now upward) is unavailable by default when using the gravity drain.

The lineset and service bundle will enter from below the unit. Rear-side connections can only be utilized when using a condensate pump (sold separately).

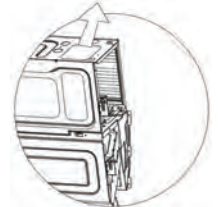

### Hanging Bolt Installation

1. Use 4x field-provided  $\frac{3}{8}$  inch mounting bolts and 8x washers / nuts to suspend the indoor unit.
2. The center-to-center distance between bolts must match the specifications provided for the unit size.
3. Follow the specific installation diagram and measurements provided in this manual to complete the hanging bolt installation.

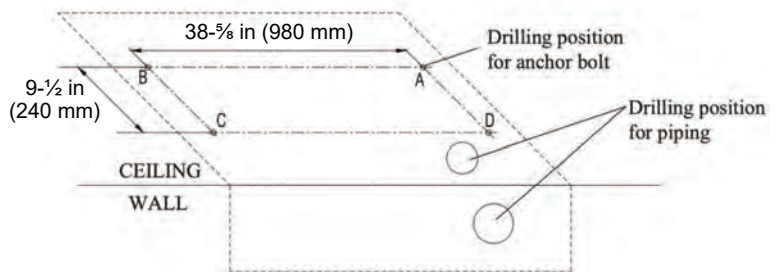

### Installation Steps

1. After positioning the hanging bolts in place, slide 1x nut and washer to each bolt. Position the nuts slightly above the final resting place of the four suspension brackets. Use tape to keep the washer in place.
2. Align the four field-provided hanging bolts into the T-groove of the indoor unit's hanging bracket.
3. Carefully lift and suspend the indoor unit using two people or a mechanical lifting device.
4. Ensure that the unit is sufficiently level (less than  $10^\circ$  upward tilt) using a bubble level / built-in level indicator.

### Assembly Notes

Attach components in the following order:

- Nut (upper)
- Gasket (upper)
- Suspension bracket
- Gasket (lower)
- Nut (lower)

### Final Mounting Notes

- Use a  $\frac{3}{8}$ -inch locking nut to secure the final assembly. Fine-tune the adjustment until the handler is level.
- Tighten all nuts firmly to ensure a stable and vibration-free installation, then re-check for levelness.
- Leave an upward tilt of 1-2/100 for drainage.
- The air gap should be  $\frac{3}{4}$  inches (19 mm) or less.

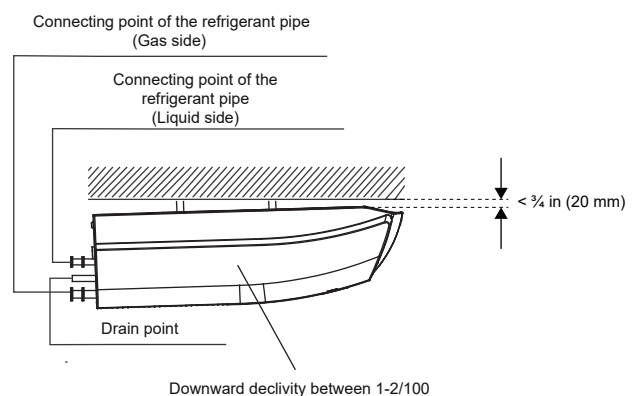
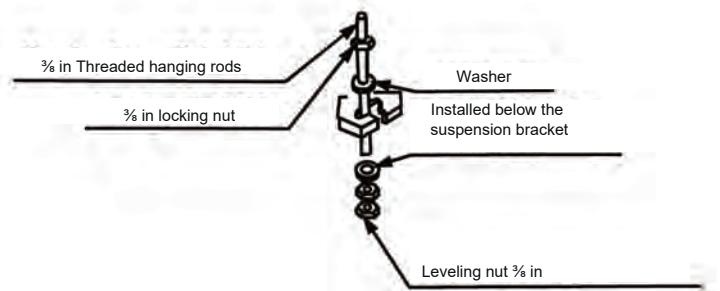

# Indoor Unit Installation Instructions

8

## Indoor Unit Condensate Piping Connections

### ! Caution

Always follow the installation manual during drainage pipe installation. The drain pipe must be properly insulated to prevent condensation.

- Insulate all drain piping and connections to the indoor unit to prevent dew formation and dripping.
- Maintain a continuous downward slope of less than  $\frac{1}{4}$  inch per foot with no dips, sags, or reverse slopes (min. slope ratio of 1/50).
- Install support straps / brackets every 5-6.5 feet (1.5-2 m) along horizontal runs to maintain proper slope and prevent sagging.
- Keep total horizontal pipe length under 65 feet (20 m).
- Follow the diagrams for correct drainage pipe routing and support methods.
- Maintain a gap of approximately  $\frac{3}{8}$  inch (10 mm) between parallel pipes if installed side-by-side.

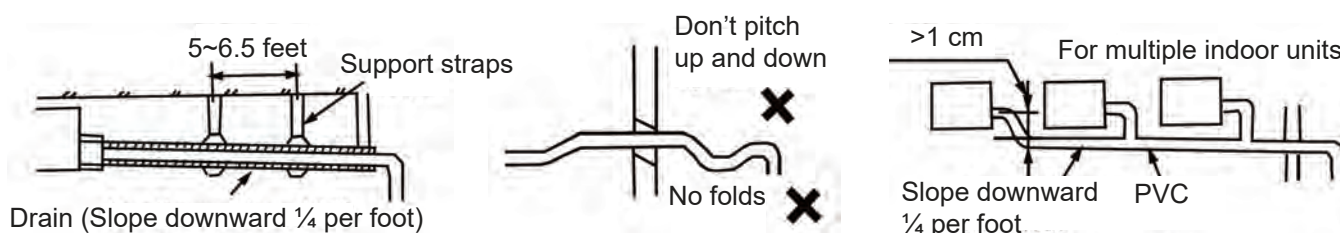

### Drain Pipe & Insulation Material Requirements

- **Drain Pipe:** Polyvinyl chloride (PVC) pipe with approximately 1- $\frac{1}{4}$  inch outer diameter (approximately 32 mm)
- **Heat Insulation:** Foamed polyethylene insulation with minimum  $\frac{3}{8}$  inch (10 mm) thickness.

### Drain Hose Installation

1. Attach the drain hose on the same side that the refrigerant piping will exit the unit from, ensuring proper drainage.
2. Attach the drain hose extensions (sold separately) to the end of the drain hose. Unlike wall-mounted systems, floor-ceiling flex systems and other light commercial air conditioners cannot use the flexible drain hoses. In order for the flexible drain hose to be utilized correctly, we recommend routing the included hose through PVC.

Here are two options:

**Option 1:** Use a rubber coupler to mate the drain hose end to a 3/4-inch PVC pipe.



**Option 2:** Insert the drain hose end into a 1-inch schedule 40 PVC pipe by using waterproofing tape to create a flush and snug seal.



# Indoor Unit Installation Instructions

## 8

### Indoor Unit Condensate Piping Connections (Continued)

3. Wrap the connection point of the drain hose firmly with Teflon tape to create a proper seal and prevent leaks.
4. For the portion of the drain hose that will remain indoors, wrap it with foam pipe insulation to prevent condensation.
5. Connect the drain hose to the PVC drainpipe.
6. Apply PVC adhesive to the connection point between the drainpipe and drain hose to ensure a watertight seal.
7. Apply the adhesive 1-½ inches (38 mm) from the end of the drainpipe, then insert it into the drain hose.
8. Allow at least 10 minutes for the adhesive to cure. Don't apply pressure to the joint during the drying period.

#### Heat Insulation

- Wrap the entire length of the flexible hose carefully with the provided insulation material, starting from the flexible hose and continuing to the indoor unit connection.
- Ensure there are no gaps or exposed sections that could cause condensation.
- Use additional field-supplied insulation material if necessary to fully cover all piping and connections.

#### Continuous Downward Pitch and No Kinks

- The drain hose must be sloped downward all throughout with an angle of 30° to prevent back flow.
- The drain must not have any kinks or points of upward flow throughout the entire channel.
- Ensure at least a 2 inch (51 mm) gap between the drain outlet and final termination point (ground, grass, etc.)

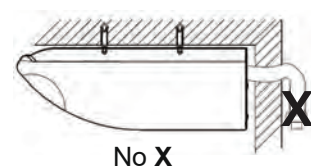
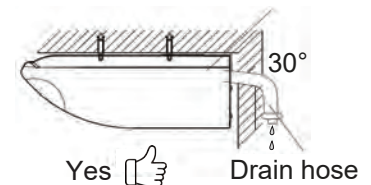

After the system installation is completed, check the condensate drain line for leaks and proper drainage. If a field-provided condensate pump has been installed, check it to ensure proper operation. Pour water into the drain pan through the inspection port to confirm flow.

# Indoor Unit Installation Instructions

# 8

## Prepare the Refrigerant Piping of the Indoor Unit

The piping "pigtailed" pre-attached to the indoor unit can be run in two different ways as shown in the illustration. Decide which type of configuration is most suitable before continuing. Confirm proper wall slope (at least ¼ inch per foot) to ensure successful condensate drainage.

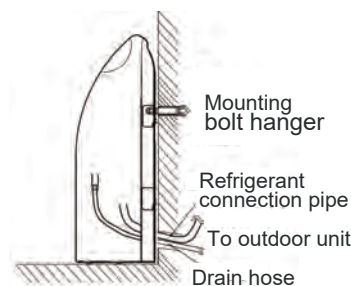
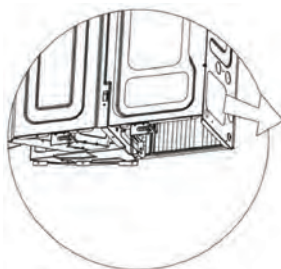
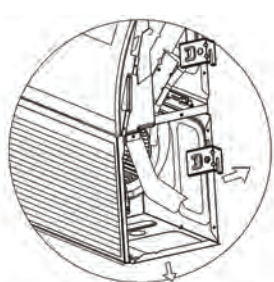

## Drill the Wall Hole for Piping

Take the inside unit off of the mounting bolts and make a mark of where the hole will be (page 34-45).

Drill a 2-½-3-⅛ inch wall hole at a slight downward angle using a core drill, being careful to avoid wires, plumbing, and other sensitive materials. The bottom of the inside holes should be ~¼ inches above the bottom of the outside hole.

Add any available wall sleeves and covers, as well as insulate the wall hole with packing putty to prevent heat loss.

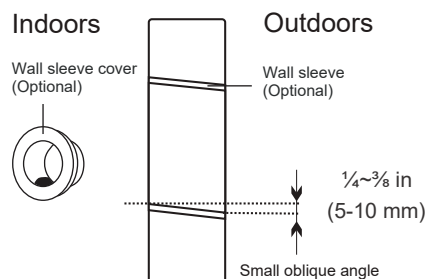
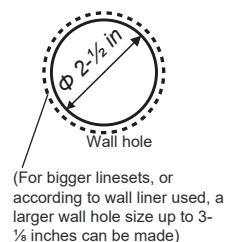

## Uncoil the Lineset

### **!** Caution

- Do not remove the seal caps from the pipe ends until it's time to connect it, avoiding contaminants from entering.
- If the pipe is bent / pulled to often, it will become stiff. Do not bend the pipe more than three times at one point. Be careful not to kink any piping.
- When extending the coiled copper pipes, straighten them by unwinding gently, as shown in the illustration.

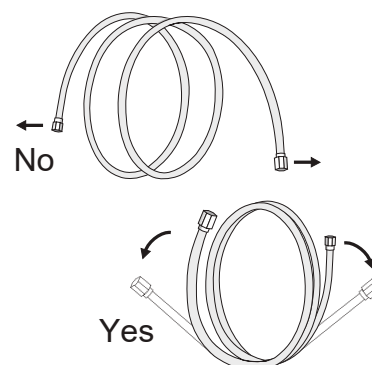

Unwind the coil gently against a flat surface, rather than pulling at the ends.

# Indoor Unit Installation Instructions

# 8

## Wire the Indoor Unit to the Outdoor Unit

### Connect the Signal Cable

Color selection does not matter as much as matching number to number does. Consult the diagram affixed to the indoor and outdoor unit respectively for specific wiring instructions. There are three terminals (1, 2, 3) and ground (G). Do not mix up the wires between each ends. It is vital that the colors between the indoor and outdoor unit match for each terminal. A simplified wiring diagram is included to the right and on the unit.

### Indoor Unit Wiring

Open the electrical junction box to access the wiring terminals. Ensure that all connecting wires are routed through the wire-inlet rubber grommet to maintain a proper seal.

Connect the wires in accordance with the wiring diagram, then verify that all the wire strands are fully inserted and securely clamped at the terminals. All connections must be tight and free of looseness.

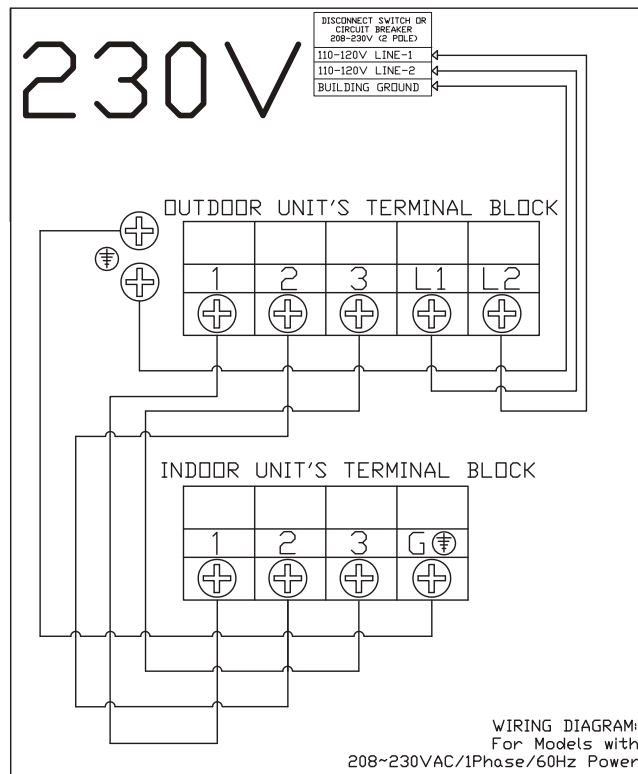

Pioneer UYT-24 Series Mini Split		18K	22K
		Sectional Area (AWG)	
Power Supply Cable	L2	12 AWG	12 AWG
	L1		
	⊕		
Connection Cable for Communication Between Indoor & Outdoor Units	3(L)	16 AWG	16 AWG
	2(N)		
	1(S)		
	⊕		

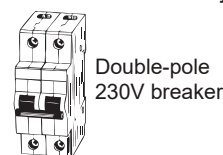
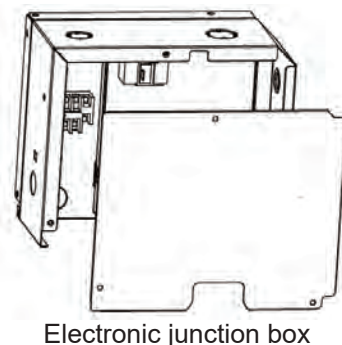

Consult the nameplate on the system for detailed electrical specifications. Confirm wiring on page 40. Above power wire sizes assume largest allowable fuse.

- 230V systems require a double-pole breaker (tandem-type will not work)

# Indoor Unit Installation Instructions

# 8

## Connect the Refrigerant Piping to the Indoor Unit

Once the copper piping kit is unwound, refer to the below instructions to proceed:

1. Bring the ends of both the copper line and the indoor unit line together. Align the centers of the pipes that will be connected.

2. Remove the indoor unit piping cap and check that no debris is inside. Some gas may be heard escaping, but it is dry nitrogen to keep lines clean.

3. Use any leak guard and/or flare sealers on the flares of the piping if available. Attach the flare nut and tighten as much as possible by hand. Torque correctly to the specifications found in the table below using two wrenches. Repeat the process for the other copper line.

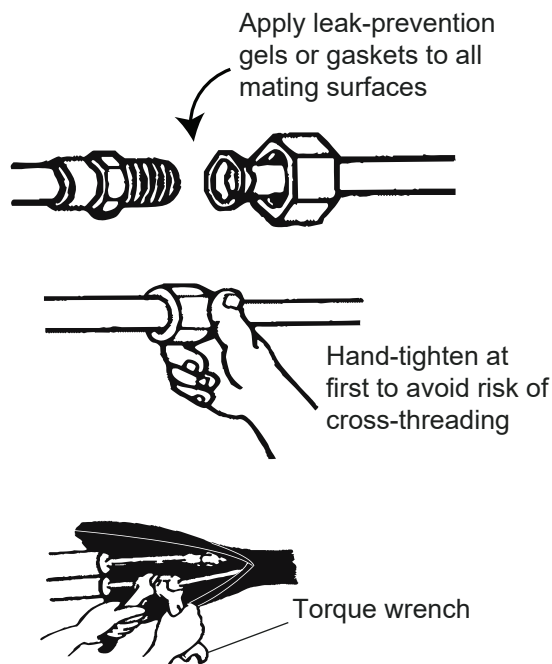

Tightening Torque for Protection Caps & Flange Connection

Pipe Diameter	Tightening Torque [N x m]	Tightening Torque [ft-lbf]	Corresponding Stress (Using a 20 cm wrench)
Φ 1/4" (6.35 mm)	15 - 20	11 - 15	Wrist Strength
Φ 3/8" (9.52 mm)	31 - 35	23 - 26	Arm Strength
Φ 1/2" (12 mm)	45 - 50	33 - 37	Arm Strength
Φ 5/8" (15.88 mm)	60 - 65	44 - 48	Arm Strength

Tightening Torque [N x m] (ft-lbf)	
Service Port Nut	[7 - 9] (5-7)
Protection Caps	[25 - 30] (18-22)

## Wrap the Lines & Sealing Air Gaps

For finishing the indoor unit, follow these steps:

1. Arrange the pipes, cables, and drain hose correctly.
2. Lag the pipe joints with insulation material and secure them with vinyl tape as depicted in the figure.
3. Run the bound bundle through the wall hole and be sure not to kink the drain pipe when binding.
4. Ensure all connections between the panel and ceiling, as well as between the panel and indoor unit are properly sealed. **Note:** Even small gaps can result in air or water leakage or cause condensation to form.

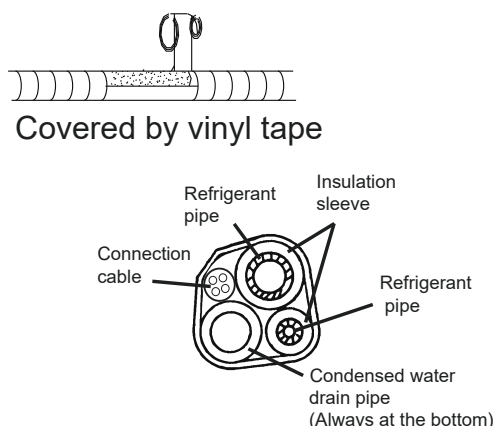

# Outdoor Unit Installation Instructions

# 9

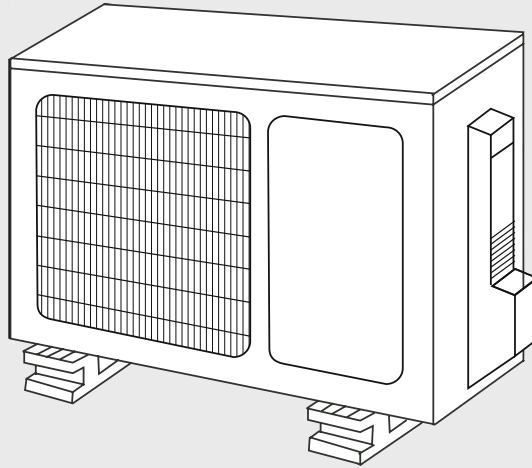

## Mount the Outdoor Unit to the Selected Location

Install the outdoor unit either on a pad or solid wall using suitable mounting brackets. Ensure it is fastened securely. Follow the procedure below before connecting any pipes or cables:

- Decide the best position on the wall or ground and leave enough space to be able to carry out maintenance easily. Anchoring dimensions are provided on page 53.
- If wall mounting, fasten the supporting brackets to the wall using hardware that is particularly suited for the type of wall. Use the appropriate amount of hardware for the application.
- Install the unit following all national regulations.

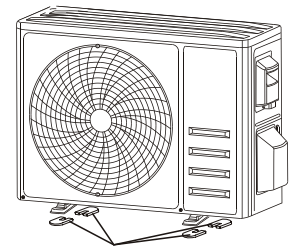

Install 4 rubber pads (Optional)

## Outdoor Unit Condensate Water Drainage

Use the drain joint and drainpipe included with the system to direct away the condensate water and ice formed in the outdoor unit during Heating mode. This is optional and only needed if the default configuration of the water drainage out from the port on the bottom side is not desired.

1. Fasten the drain port in the 1 inch (25 mm) port located in the part of the unit depicted in the diagram.
2. Connect the drain port and drainpipe.
3. Ensure the condensate will drain to a suitable place.

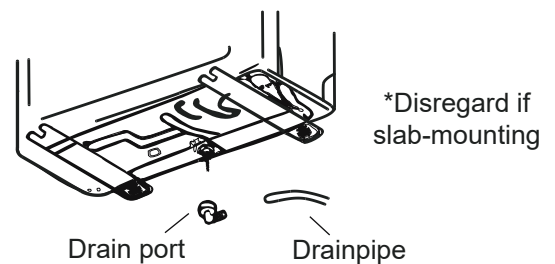

# Outdoor Unit Installation Instructions

# 9

## Outdoor Unit Installation Location Selection

Follow the below best practices for selecting an optimal installation space of the indoor unit:

- Do not install the unit near sources of heat, steam, or flammable gases.
- Do not install the system in areas prone to extreme winds or dust.
- Do not install the outdoor unit in an area that has many individuals pass by.
- Select a location where the air discharge and operating sound level will not disturb others.
- Install the system in a shaded area or utilize a cover/sun protection that will not interfere with air flow. This will also protect the system from heavy rain or snow.
- Install the unit in a safe and sturdy location.
- Install rubber vibration absorbers if the system can induce vibrations in any structure.
- Obey the following tolerances depicted in the illustration below to ensure air flow:

## Minimum Required Installation Space

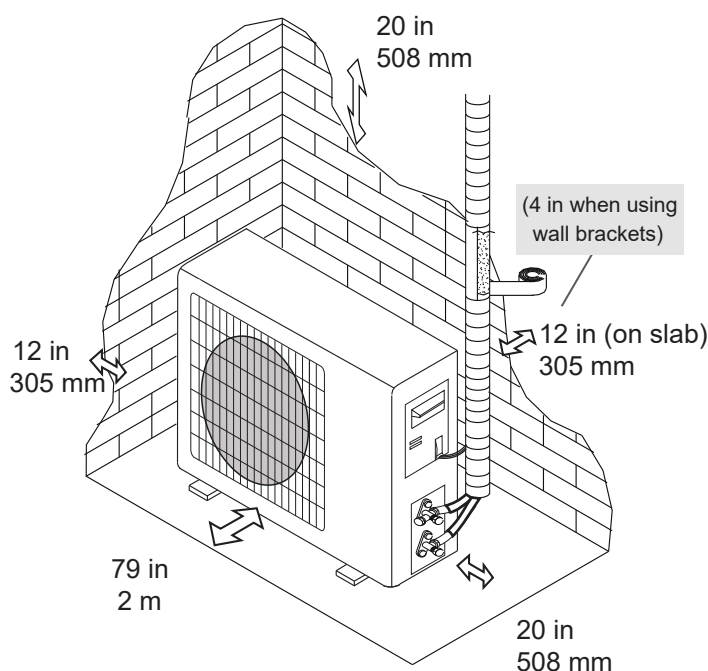

### Special Considerations for Extreme Weather Conditions

**If the unit is exposed to heavy wind:** Install the unit so that the air outlet fan is at a 90° angle to the direction of the wind. If needed, use wind baffles or build a barrier in front of, but sufficiently away from, the unit to protect it from extremely heavy winds.

### For Best Longevity & Performance in Precipitation / Airflow / Salty Air

**If the unit is frequently exposed to heavy rain or snow:** Build a shelter above the unit to protect it from the rain or snow. Be careful not to obstruct the air flow around the unit.

**If the unit is frequently exposed to salty air (seaside air):** Use specifically approved anti-corrosion coating sprays on the heat exchanger surface in order to resist corrosion.

# Outdoor Unit Installation Instructions



## Read These Regulations Before Performing Any Electrical Work

1. All wiring must comply with local and national electrical codes and must be installed by a licensed electrician.
2. All electrical connections must be made according to the Electrical Connection Diagram located on the side panels of the indoor and outdoor units.
3. If there is a serious safety issue with the power supply, stop work immediately. Explain your reasoning to the client and suspend the installation of the unit until the safety issue is properly installed.
4. The power voltage should be within 90-110% of the rated voltage range. Insufficient power supply can cause electrical shocks or fires.
5. Connect the power through fixed wiring, install a surge protector\*, and disconnect the switch box. Use a dedicated circuit breaker with a capacity of 1.5 times the maximum current of the unit.
6. A properly-rated HACR-type fuse or circuit breaker that disconnects all poles and has a contact separation of at least 1/8 inch (3 mm) must be incorporated in the fixed wiring. The qualified technician must use an approved circuit breaker or switch.
7. Only connect the unit to a dedicated individual branch circuit breaker. Do not connect another appliance to that same circuit.
8. Be sure to properly ground the air conditioner.
9. Every wire must be firmly connected. Loose wiring can cause the terminal to overheat, resulting in product malfunction and possible fire.
10. Do not let wires touch or rest against the refrigerant tubing, compressor, or any other moving parts within the unit.

\*optional, highly recommended.



## Warning

Before performing any electrical or wiring work, turn off the main power source or sources to the system.

1. Prepare the cable for connection:

## Use the Right Cable

- Outdoor power cable: THHN or THWN
- Signal cable: TC-ER or better (AWG #16)

## Minimum Cross-Sectional Area of Power & Signal Cables North America

Circuit Breaker Size (A)	Wire Size (AWG)
10	18
13	16
15	14
20	12
30	10

Indoor Unit Terminal Position #1 connects to Outdoor Unit Terminal Position #1

Indoor Unit Terminal Position #2 connects to Outdoor Unit Terminal Position #2

Indoor Unit Terminal Position #3 connects to Outdoor Unit Terminal Position #3

Indoor Unit Terminal Position "Ground" connects to the Outdoor Unit Grounding Lug.

Using wire strippers, strip the rubber jacket from both ends of the cable to reveal about 1.5 inch (40 mm) of the wires inside. Strip the insulation from the ends of the wires. Using a wire crimper, crimp u-lugs on the ends of the wires. **Note:** Some cables come with preinstalled u-lugs from the factory.

# Outdoor Unit Installation Instructions

# 9

## Power/Signal Electrical Wiring to the Outdoor Unit

On the outdoor unit, the wiring diagram is located in the inner side of the handle cover.

An electrical wiring cover on the side of the unit protects the outside unit's terminal block. A comprehensive wiring diagram is printed on the inside of the wiring cover.

1. Unscrew and remove the handle on the right side plate of the outdoor unit.
2. Wire the system using the appropriate gauge wire found on pages 36/40 and the wiring diagram found on the handle cover.
3. Use a proper flexible rain-tight conduit with appropriate size connectors.
4. Fasten the power connection wires into place using the supplied wire clamps.
5. Check the wiring against the diagram to ensure it is wired correctly. A proper ground connection must be established.
6. Rescrew and reinstall the cover handle.

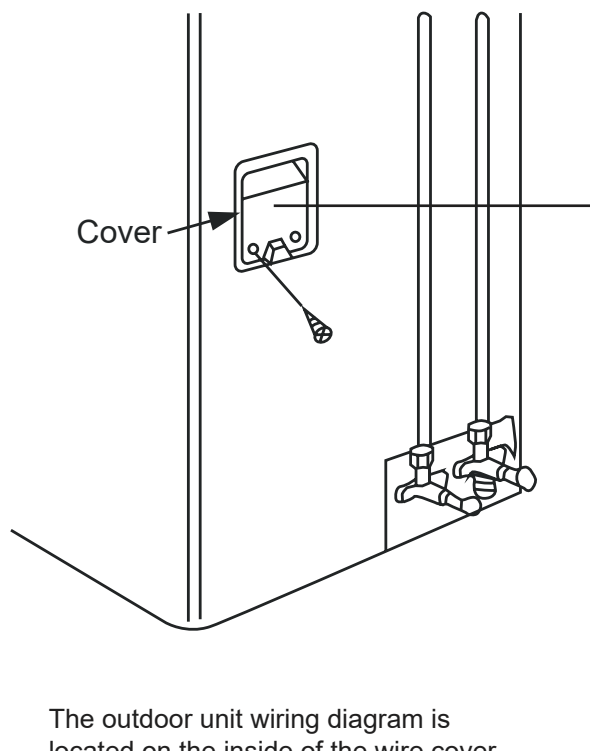

The outdoor unit wiring diagram is located on the inside of the wire cover on the outdoor unit.

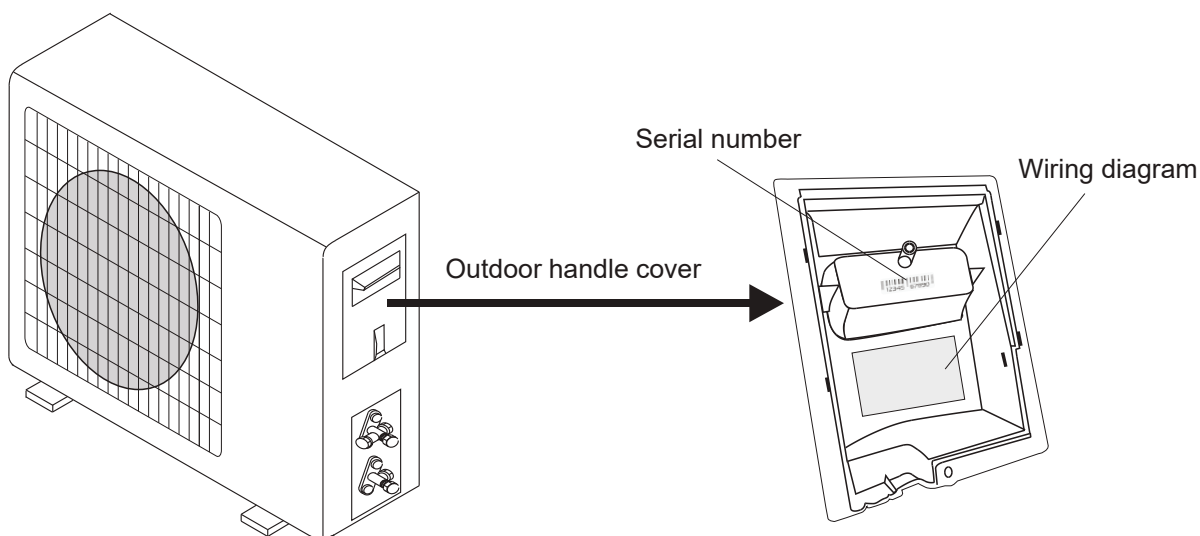

# Outdoor Unit Installation Instructions

# 9

## Connect the Refrigerant Piping

The length of the refrigerant piping will affect the performance and energy efficiency of the unit. Nominal efficiency is tested on units with a pipe length of 16 feet (4.9 m). Factory precharge is sufficient for supporting up to 25 feet (7.6 m) of connected lineset. Piping should not be shorter than 10 feet (3 m) in length. Refer to the table below for specifications on the maximum length and drop height of the piping. If the factory precharge is modified, make a note of the charge modification amount on page 58.

Pioneer UYT-24 Series Mini Split Model / Capacity (BTU/h)	18K BTU	22K BTU
Liquid Pipe Diameter	Φ ¼ inch (6.35 mm)	Φ ¼ inch (6.35 mm)
Gas Pipe Diameter	Φ ½ inch (12 mm)	Φ ¾ inch (15.88 mm)
Length of Pipe with Standard Charge	25 ft / 7.6 m	25 ft / 7.6 m
Maximum Distance Between Indoor and Outdoor Unit	65 ft / 20 m	65 ft / 20 m
Additional Refrigerant Charge (For each add'l foot after 25 ft.)	0.11 oz / ft 10 g / m	
Max. Difference in Level Between Indoor and Outdoor Unit	50 ft / 15 m	50 ft / 15 m
Type of Refrigerant	R-454B	

### Connection Instructions – Refrigerant Piping

#### Step 1: Cut Pipes (if cutting the lineset shorter)\*

When preparing refrigerant pipes, take care to cut and flare them properly. This will ensure efficient operation and minimize the need for future maintenance.

1. Measure the distance between the indoor and outdoor units.
2. Use a rolling blade type pipe cutter to cut the pipe a little longer than the measured distance.
3. Make sure that the pipe is cut at a perfect 90° angle. Refer below for bad cut examples.

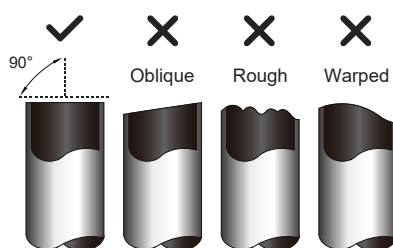

\*Most standard linesets are pre-flared. In some cases, modifications are needed.

### ! Do Not Deform Pipe While Cutting

Be careful not to damage, kink, or deform the pipe while cutting. This will drastically reduce the efficiency and capacity of the unit and may cause internal damage.

#### Step 2: Remove Any Burrs Carefully

Burrs can affect the air-tight seal of the refrigerant piping connection. They must be completely removed. Follow these steps for proper deburring.

1. Hold the pipe at a downward angle to prevent burrs from falling into the pipe.
2. Use a reamer or deburring tool to remove all burrs from the cut section of the pipe.

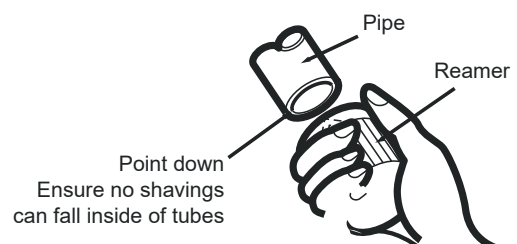

# Outdoor Unit Installation Instructions

# 9

## Connect the Refrigerant Piping (Continued)

### Step 3: Flare Pipe Ends

Proper flaring is essential to achieve an airtight seal.

1. After removing burrs from the cut pipe, seal the ends with PVC tape to prevent foreign materials from entering the pipe.
2. Sheath the pipe with insulating material.
3. Place flare nuts on both ends of the pipe. Make sure they are facing the correct direction, because they cannot be put on or have their direction changed after flaring.

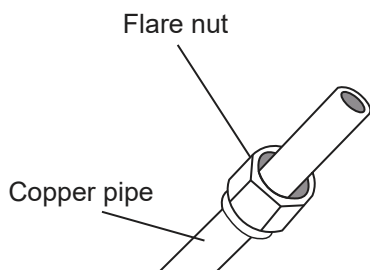

4. Remove the PVC tape from ends of the pipe when preparing to perform flaring work.
5. Clamp the flare form on the end of the pipe. The end of the pipe must extend beyond the edge of the flare form in accordance with the dimensions shown in the following table:

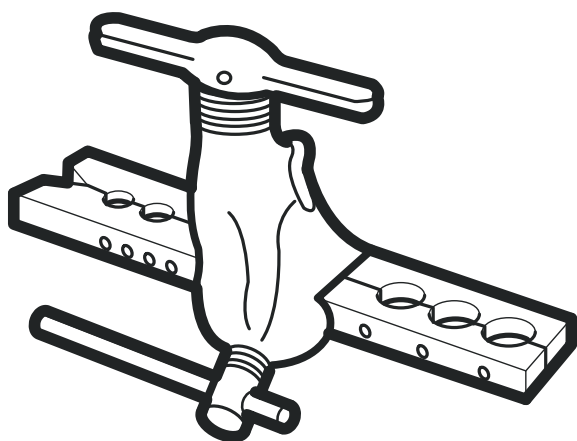

### Piping Extension Beyond Flare Form

Outer Diameter of Pipe (inch/mm)	A (inch/mm)	
	Min.	Max.
Ø 1/4" (Ø 6.35)	0.03" (0.7)	0.05" (1.3)
Ø 3/8" (Ø 9.52)	0.04" (1.0)	0.06" (1.6)
Ø 1/2" (Ø 12.7)	0.04" (1.0)	0.07" (1.8)
Ø 5/8" (Ø 16)	0.08" (2.0)	0.09" (2.2)
Ø 3/4" (Ø 19)	0.08" (2.0)	0.1" (2.4)

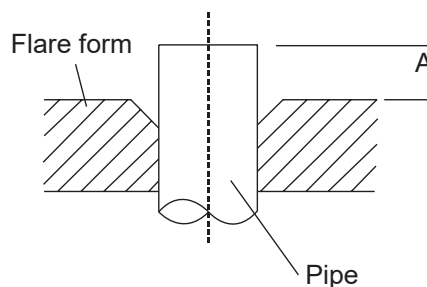

6. Place flaring tool onto the form.
7. Turn the handle of the flaring tool clockwise until the pipe is fully flared.
8. Remove the flaring tool and flare form, then inspect the end of the pipe for cracks.

### Step 4: Connect Pipes

When connecting the refrigerant pipes, be careful not to use excessive torque or deform the piping in any way. Begin by connecting the low-pressure pipe, then the high-pressure pipe.

If provided by the supplier, apply leak guard material on all flared mating surfaces. Do not use any plumbing or putty sealants.

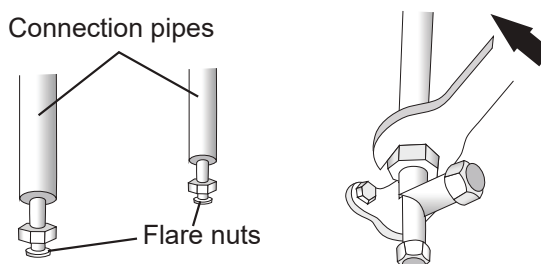

# Outdoor Unit Installation Instructions

# 9

## Connect the Refrigerant Piping (Continued)

### Instructions for Connecting Piping to Outdoor Unit

1. Unscrew the cover from the packed valve on the side of the outdoor unit.

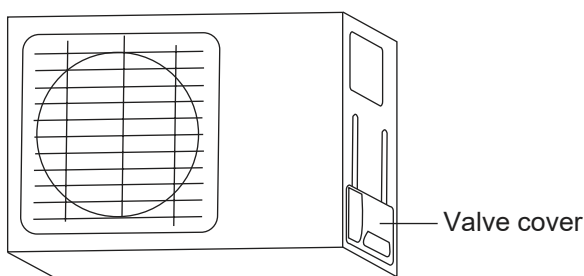

2. Remove the protective caps from the valve ends.
3. Align the flared pipe end with each valve and tighten the flare nut as tightly as possible by hand.
4. Use a spanner to grab the body of the valve. Do not grab the nut that seals the service valve.

### ! Use Spanner to Grab the Body of the Service Valve

Torque from tightening the flare nut can snap off other parts of valve.

5. While firmly gripping the body of the valve, use a torque wrench to tighten the flare nut according to the correct torque values.
6. Loosen the flaring nut slightly, then tighten again.
7. Repeat steps 3 to 6 for the remaining pipe.

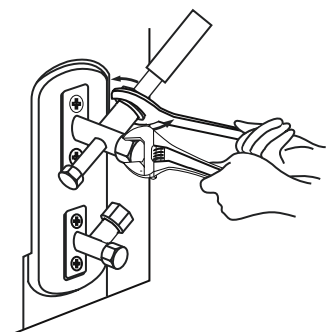

### Minimum Bend Radius

When bending connective refrigerant piping, the minimum bending radius is 4 inches (102 mm).

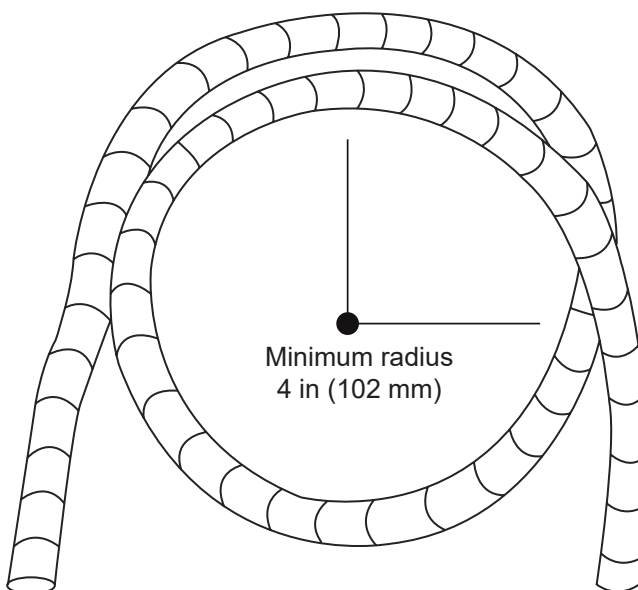

### ! Do Not Use Excessive Torque

Excessive force can break the nut or damage the refrigerant piping. Do not exceed the torque requirements shown in the table shown on page 37.

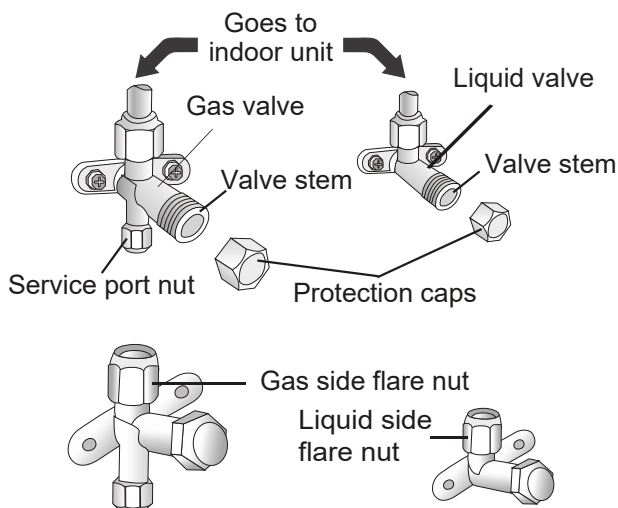

# Outdoor Unit Installation Instructions

# 9

## Air Evacuation & Bleeding the Circuit

The air and/or humidity left inside the refrigeration circuit can contaminate the refrigerant and cause abnormal spikes in pressure, leading to eventual compressor malfunctions. Therefore, after connecting the indoor and outdoor units to create a closed system, it is necessary to bleed the air and humidity out of the circuit by using a vacuum pump.

Perform the evacuation after the initial installation or when the unit is relocated. For first time installations, do not prematurely release the refrigerant prior to evacuation. Keep the valve caps sealed.

### Before Performing Evacuation

- ☑ Check to make sure that both high-pressure and low-pressure pipes between the indoor and outdoor units are connected properly in accordance with the "Refrigerant Piping Connection" section of this manual.
- ☑ Check to make sure all wiring is connected properly and is fully enclosed and insulated.

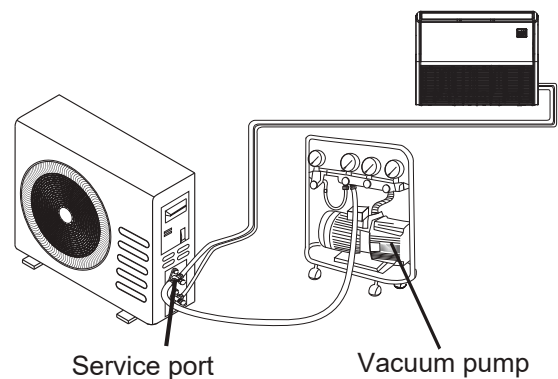

## Evacuation Instructions

Before using a vacuum pump and manifold gauge, read their operation manuals to become familiarized with using them properly.

1. Remove the caps from the 2-way and 3-way valves (do not manipulate the valves until step 11).
2. Unscrew and remove the cap from the service port (see the diagram on the right side).
3. Connect the blue (low) hose of the manifold gauge to the service port on the outdoor unit's 3-way valve. Use an adapter if needed. Ensure that the pin fully engages the Schrader valve.
4. Connect the yellow (middle) hose from the manifold gauge to the vacuum pump.
5. Open the low pressure valve of the manifold gauge\*. Keep the high pressure valve closed.

\*Refers to the manifold set, not the outdoor unit valves.

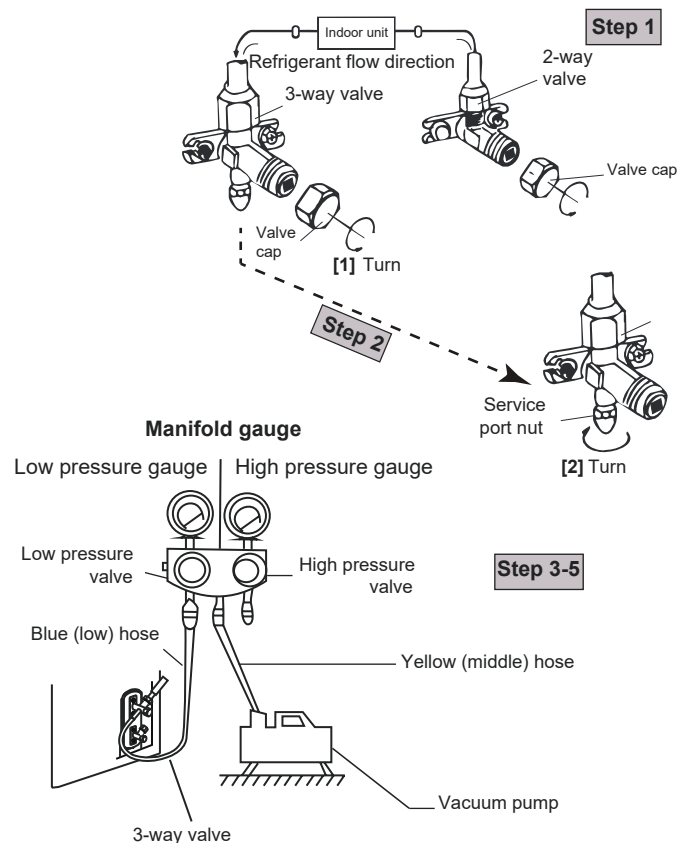

# Outdoor Unit Installation Instructions

# 9

## Evacuation Instructions (Continued)

6. Turn on the vacuum pump to evacuate the system.
7. Run the vacuum for at least 15 minutes or until the Compound Meters reads -76cmHG (-100 kPa or -30 inHg). The vacuum reading should gradually decrease.
8. Close the low pressure side of the manifold gauge and turn off the vacuum pump.
9. For the best results, wait for at least 1 hour, then verify that there has been no increase in the vacuum reading.
10. If there is a rise in the system vacuum, refer to the "Gas Leak Check" section for information on how to check for leaks. If there is no change in the vacuum reading, unscrew the cap from the service valve (high pressure valve).
11. Insert the Allen wrench into the service valve (2-way valve) and open the valve by turning the wrench in a ¼ counterclockwise turn. Wait and listen for gas potentially exiting the system, then close the valve after 5 seconds.
12. Watch the pressure gauge for a few minutes to make sure that there is no drop in pressure. The pressure gauge should now show higher than the atmospheric pressure.
13. Remove the charge hose from the service port.
14. Use a hexagonal wrench to fully open both the high pressure and low pressure valves counterclockwise.
15. Tighten valve caps on all three valves (service port, high pressure, low pressure) by hand. Do not torque down further.

**Do not** open either of these valves until evacuation steps are completed and the system is ready for startup (steps 11-15)

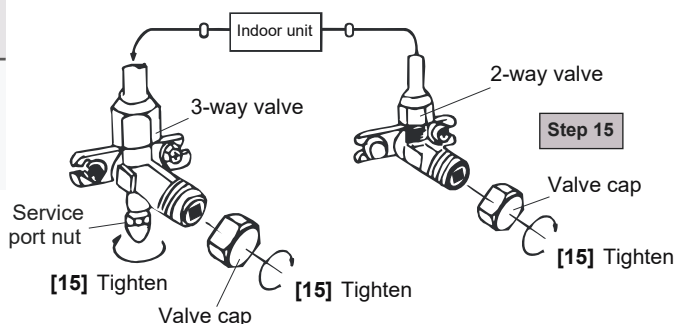
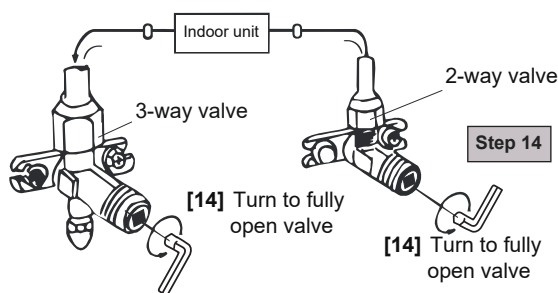
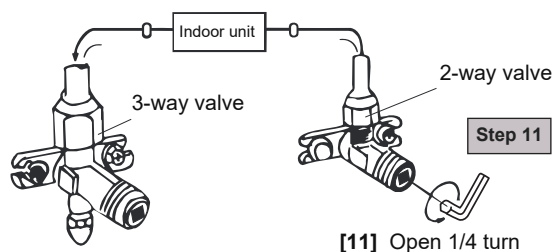
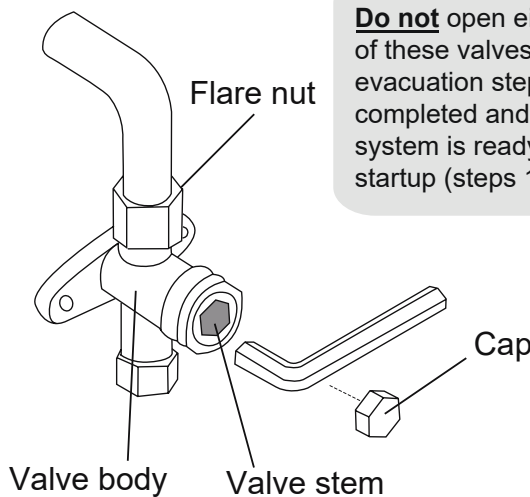

### ! Open Valve Stems Gently

When opening valve stems, turn the supplied Allen wrench until the valve stem comes into contact with the stopper. Do not try to force the valve to open further.

# Electrical/Gas Leak Check & Test Run

# 10

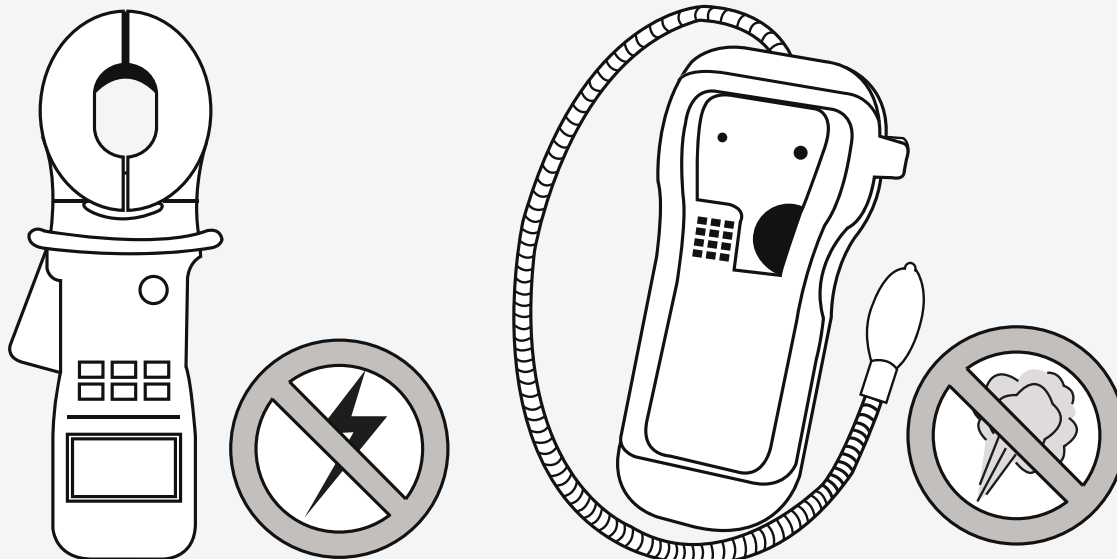

## Electrical Safety Checks

After installation, confirm that all electrical wiring is installed in accordance with local and national regulations and the installation manual.

## Before Test Run

- ✓ Check grounding work.
- ✓ Measure grounding resistance by visual detection or with a grounding resistance tester. Grounding resistance must be less than  $4\Omega$ .

**Note:** This may not be required in some locations.

## During Test Run

- ✓ Check for electrical leakage.
- ✓ During the test run, use an electroprobe and multimeter to perform a comprehensive electrical leakage test.
- ✓ If electrical leakage is detected, turn off the unit immediately and call a licensed electrician to find and resolve the cause of the leakage.

**Note:** This may not be required in some locations.



## Warning – Risk of Electric Check

All wiring must comply with local and national electrical codes and must be installed by a licensed electrician.

## Gas Leak Checks

There are two methods to check for gas leakage:

- ✓ **Soap and Water Method**  
Use a soft brush to apply soapy water or liquid detergent to all pipe connection points on the indoor and outdoor units. The presence of bubbles indicates a leak.
- ✓ **Leak Detector Method**  
If using a leak detector, refer to the device's operation manual for proper usage instructions.

## After Performing Gas Leak Checks

After confirming that all the pipe connection points do not leak, replace the valve cover on the outside unit.

# Electrical/Gas Leak Check & Test Run

# 10

## Test Run

### Before Test Run

Only perform a test run after the following steps have been completed:

- Electrical Safety Checks**  
Confirm that the unit's electrical system is safe and is operating properly.
- Gas Leak Checks**  
Check all flare nut connections and confirm that the system is not leaking.
- Gas Leak Checks**  
Confirm that both the gas and liquid valves (high/low) are 100% fully opened. ↻

### Test Run Instructions

Perform the following test run for 30 minutes:

1. Connect power to the unit.
2. Press the On/Off button on the remote controller to turn it on.
3. Press the Mode button to scroll through the following functions, one at a time.
  - Cool - Select lowest possible temperature
  - Heat - Select highest possible temperature
4. Let each function run for 5 minutes and perform the following checks:

## Pass/Fail?

- **No electrical leaks or abnormal noises**
- **Unit is properly grounded**
- **All electrical terminals are properly covered**
- **Indoor and outdoor units are securely installed**
- **All pipe connections points do not leak**
- **Water drains from drain hose properly**
- **All piping is properly insulated**
- **Indoor unit responds to the remote controller**
- **Indoor unit louvers work properly**
- **System works in both Heat + Cool mode**

### After Test Run Completion

After the 10 boxes above have been checked and marked as passed, perform the following operation:

1. Use the remote control to return the system to a normal desired operating temperature.
2. Use the insulation tape to wrap the indoor unit's refrigerant pipe connections that were left uncovered during the installation process.

### If Ambient Temperatures Are Too High to Run a Heating Test:

If outside temperatures are too high to permit Heating mode on the remote controller, do the following:

1. Turn the unit on and put it in Heating mode using the emergency button as depicted on page 6.
2. Run the Heating mode test as normal and turn the unit back off using the button when complete.

### Double Check All Pipe Connections

During operation, the pressure of the refrigerant circuit will increase. This may reveal leaks that were not present during the initial leak check. Take time during the test run to double-check that all copper pipe connection points are leak-free. Refer to the Leak Check page for instructions. Cooling mode pressure should be 120-155 PSI. Heating mode pressure should be 320-450 PSI.

# Troubleshooting

# T

Malfunction	Possible Causes
If the appliance does not operate or respond...	There is a power failure / plug pulled out or tripped / wrong breaker (wrong wiring)
	The indoor / outdoor unit fan motor is damaged
	There is a faulty compressor or thermomagnetic circuit breaker
	There is a faulty protective device or fuses
	The electrical connections are loose
	The system has entered a protection mode
	The system has entered an overvoltage or undervoltage protection
	The Timer-On function is active
The electronic control board was damaged	
If there are strange odors...	The air filter is dirty
If there is running water...	There is a back-flow of condensate water into the system's drain pan.
If a fine mist is coming from the air outlet...	This occurs when the air in the room becomes considerably cold. For example in "Cooling" or "Dehumidification / Dry" modes
If strange noises are being emitted...	This noise is made by the expansion or contraction of the front panel due to variations in temperature. If so, this is normal
If the airflow is insufficient, and the air is not hot or cold enough...	The temperature setting is unsuitable
	The air conditioner intakes and outlets may be obstructed
	The air filter may be dirty
	The fan speed may be set at the minimum
	There may be too many other heat sources in the room
If the appliance does not respond to commands...	The system may be getting low on refrigerant. Pressures should be checked
	The remote control may not be close enough to the indoor unit
	The batteries of the remote control may need to be replaced
If the display is off...	There are obstacles between the remote control and indoor unit signal receiver
	The Display button has been pressed
Switch off the air conditioner immediately and cut off the power supply in the event of...	There has been a power failure
	Strange noises not due to expansion/contraction are heard during operation
	The electronic control board is faulty or malfunctioning
	Any fuses or switches are faulty or malfunctioning
	The sound of spraying water or objects are heard inside the appliance
	The cables or plugs have overheated
There are very strong odors being emitted from the appliance	

## Error Signals on the Display

In case of errors, the display on the indoor unit may show the following codes:

Display	Description of the error	Display	Description of the error
E1	Indoor temperature sensor fault	E8	Outdoor discharge temperature sensor fault
E2	Indoor pipe temperature sensor fault	E9	Outdoor IPM module fault
E3	Outdoor pipe temperature sensor fault	EA	Outdoor current detection fault
E4	Refrigerant system leakage or fault	EQ	Indoor ↔ Outdoor unit communication fault
E6	Malfunction of the indoor fan motor	F4	Refrigerant leak / Low pressure detected
E7	Outdoor air temperature sensor fault	EH	Outdoor suction temperature sensor fault

Do not attempt to use the system until the error code is diagnosed and resolved. Forcing the system to run can cause irreversible damage.

# Troubleshooting

# T

## Solutions to Common Issues & Scenarios

### Issue: The indoor air handler does not turn on

- Solution: Try the manual emergency button on the indoor unit in order to rule out problems with the remote controller.
- Solution: Verify that the wire order is equal between the indoor and outdoor units [1]. The color order must match. Check for splices or damage on the control cable. To rule out variables, remove any accessorial items, such as UV lights or condensate pumps, until the problem is resolved.
- Solution for 230V systems: Use a multimeter to check the AC voltage across terminals L1-L2 on the outdoor system [2]. Touch one probe to L1, the other probe goes on L2. Do not measure each leg to ground. Verify whether the reading is between 208~253 VAC.
  - If the reading is between 208~253 VAC, measure whether the reading is the same across 2-3 on both the outdoor and indoor units. All readings must match. The system must receive a full 230V reading in order to function.
  - If the reading is 0 VAC, then the system is not receiving proper power from the power source. Some common reasons are:
    - A fused disconnect is being used, but fuses are blown and not inserted properly.
    - The disconnect box bus-bar is in the Off position.
    - A double-pole breaker is not being used. Single or tandem breakers will not operate.

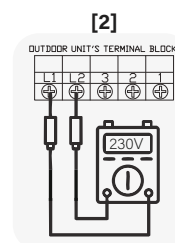
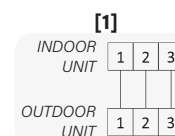

### Issue: The pressure reading does not rise when releasing refrigerant during the leak check

- Solution: Verify that the gauge tube pin on the manifold gauge is fully engaging the outdoor unit service port's Schrader valve. A pin that is over or underexposed will not allow the gauge to access the refrigerant circuit, preventing pressure measurement and/or proper vacuuming. The depressor pin inside the hose connector is adjustable for proper Schrader valve engagement.
  - A telltale sign that this is happening is whether the gauge reading goes to instant vacuum when the pump is first turned on. This means only the gauge is being vacuumed.
  - If so, vacuuming will need to be re-performed, since only the gauge itself was vacuumed.

# Troubleshooting



## Solutions to Common Issues & Scenarios (Continued)

### **Issue: The system is not holding a vacuum**

- Solution: A leak in the gauge hoses is likely. Repair the leak and check the vacuum pump.
- Solution: Check the connection points for proper contact and torque, then tighten if necessary.

### **Issue: The indoor air handler is leaking water**

- Solution: Verify that the indoor unit is both horizontally and vertically leveled.
- Solution: Confirm that the drain tube is at a continuous downward pitch.
  - Pour a cup of water over the indoor unit's coils so that it reaches the drain pan.
  - Verify that the water drains out of the tube freely. If it doesn't, find the cause and correct it.

### **Issue: The system indicates that a refrigerant leak is present**

- Solution: Cut off the power to the system. Prepare a soapy water spray and spray the connection points of the lineset. The point where the bubbles form is where the leak is located. Tighten the connection and re-test the system. After the leak is repaired, re-charge the system.

### **Issue: The fan runs in Cooling mode but in Heating mode there is weak or no airflow**

- Solution: The fan speed control is typically not available to the user in Heating mode. If the coil is unable to heat up, then the fan will not run at speed. This may indicate low refrigerant as well.

# Troubleshooting

# T

## Full Error Codes List

Error Code	Code Interpretation
E0	Indoor < > Outdoor Communication Fault
E1	Indoor Room Temperature Sensor Fault
E2	Indoor Fan Coil Temperature Sensor Fault
E3	Outdoor Unit Fan Coil Temperature Sensor Fault
E4	Abnormal System Malfunction / Lack of Refrigerant
E5	Model Configuration / Mismatch Error
E6	Indoor Unit DC Fan Fault
E7	Outdoor Unit Ambient Temperature Sensor Fault
E8	Outdoor Unit Discharge Temperature Sensor Fault
E9	Outdoor Unit IPM/Compressor Drive Abnormal Fault
EA	Outdoor Unit Current Sensor Test Fault
Eb	Main PCB < > LED Display Communication Fault
EC	Outdoor Unit Module Communication Fault
EE	Outdoor Unit EEPROM Fault
EF	Outdoor Unit DC Fan Motor Fault
EH	Outdoor Unit Suction Sensor Fault
EP	Outdoor Unit Compressor Casing Top Fault
EU	Outdoor Unit Voltage Sensor Fault
Ej	Outdoor Unit Central Coil Temperature Sensor Fault
En	Outdoor Unit Gas Pipe Temperature Sensor Fault
Ey	Outdoor Unit Liquid Pipe Temperature Sensor Fault
P0	IPM Module Protection
P1	Overvoltage / Undervoltage Protection
P2	Overcurrent Protection
P3	Other Protection
P4	Excessive Outdoor Discharge Temperature Protection
P5	Cool Mode Sub-Cooling Preventative Protection
P6	Cool Mode Overheating Preventative Protection
P7	Heat Mode Overheating Preventative Protection
P8	Outdoor Unit Over / Under-Temperature Protection
P9	Compressor Drive Abnormal Load Protection
PA	Preset Mode Conflict / IDU Top Flow Comm. Fault

Error Code	Code Interpretation
F0	Infrared Sensor Fault
F1	Power Test Module Fault
F2	Discharge Temperature Sensor Fault Protection
F3	Outdoor Coil Temperature Sensor Fault Protection
F4	Cooling System Gas Flow Abnormality Protection
F5	PFC Protection
F6	Compressor Lack of Phase / Anti-Phase Protection
F7	IPM Module Temperature Protection
F8	4-Way Reversing Valve Abnormality Protection
F9	Module Test Circuit Temperature Fault
FA	Compressor Phase Current
Fb	Cooling / Heating Overload Limit Frequency Protection
FC	High Power Limit / Frequency Reduction Protection
FE	Module / Compressor Phase Current Protection
FF	Module Temperature Frequency Reduction Protection
FH	Drive Limit / Frequency Reduction Protection
FP	Anti-Condensation Frequency Reduction Protection
FU	Anti-Freezing Frequency Reduction Protection
Fj	Discharge Protection Limit / Frequency Protection
Fn	External AC Current Limit / Frequency Protection
Hd	Refrigerant Leakage Protection
Fd	Refrigerant Leak Sensor Abnormal Comm. Protection
Fy	Refrigerant Deficiency Protection
H1	High-Pressure Switch Malfunction
H2	Low-Pressure Switch Malfunction
bf	TVOC Sensor Fault (optional)
bc	PM2.5 Sensor Fault (optional)
bj	Humidity Sensor Fault (optional)
bE	CO2 Sensor Fault (optional)
bd	Fresh Air Fan Fault (optional)
d4	Water Full Protection
d5	Access Control Protection

# Appendix

# A

## Anchor the Outdoor Unit

The outdoor unit can be anchored to the ground or to wall-mounted brackets. The following is a list of different outdoor unit sizes and the distance between their mounting feet. Prepare the installation base of the unit according to the dimensions found below:

Model	D	E	F	G	H	I	J	K
<b>YN018GLSI24RPG</b> (18,000 BTU - 230V)	845 mm	699 mm	326 mm	586 mm	375 mm	348 mm	55 mm	58 mm
	33- $\frac{1}{4}$ in	27- $\frac{1}{2}$ in	12- $\frac{7}{8}$ in	23- $\frac{1}{8}$ in	14- $\frac{3}{4}$ in	13- $\frac{3}{4}$ in	2- $\frac{1}{8}$ in	2- $\frac{1}{4}$ in
<b>YN024GLSI24RPG</b> (22,200 BTU - 230V)	910 mm	803 mm	359 mm	607 mm	421 mm	390 mm	60 mm	63 mm
	35- $\frac{7}{8}$ in	31- $\frac{5}{8}$ in	14- $\frac{1}{8}$ in	23- $\frac{7}{8}$ in	16- $\frac{5}{8}$ in	15- $\frac{3}{8}$ in	2- $\frac{3}{8}$ in	2- $\frac{1}{2}$ in

**Note:** If pairing with a multi-circuit outdoor unit, see Addendum manual for other diagrams

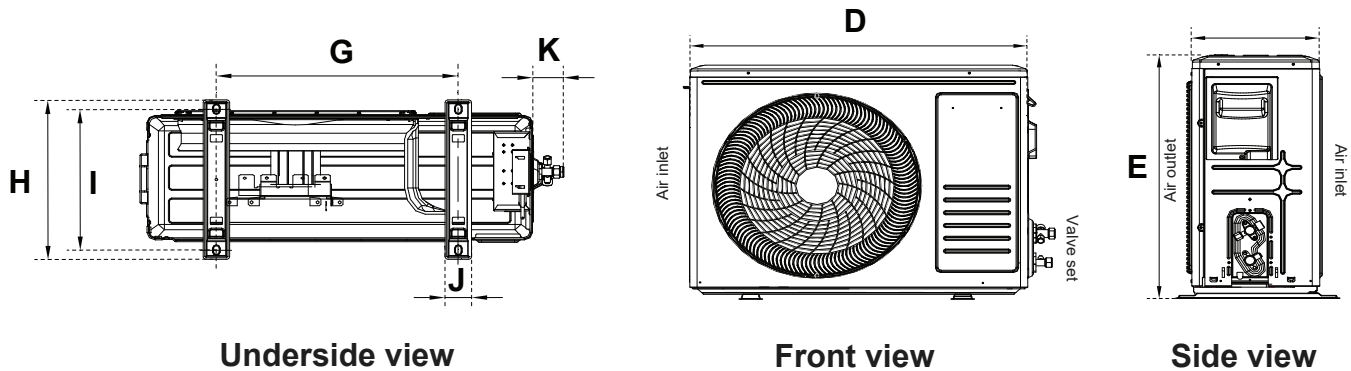

Underside view

Front view

Side view

When mounting on slabs, the installation of the drain joint and tubing shown on page 38 is not necessary.

If installing the unit on the ground or a concrete mounting platform, complete the following:

1. Mark the positions for the four expansion bolts based on the dimensions in the "Unit Mounting Dimensions" chart.
2. Pre-drill holes for expansion bolts.
3. Clean concrete dust away from holes.
4. Place a nut on the end of each expansion bolt.
5. Hammer expansion bolts into each hole.
6. Remove the nuts from expansion bolts and place the outdoor unit onto the bolts.
7. Put washers onto each expansion bolt, then replace each of the nuts.
8. Using a wrench, tighten each nut until snug.

**WHEN DRILLING INTO CONCRETE, WEAR EYE PROTECTION AT ALL TIMES!**

### Indoor Unit Display Panel Indicators

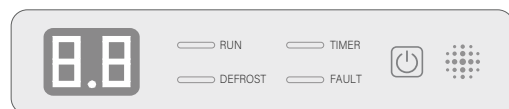

#### Running Light (Run)

- Begins by flashing when power-on
- Turns solid when the unit is running and displays the set temperature on the digital display.
- Turns off when the unit is shut down.

#### Timing Light (Timer)

- Lights up when a timer is set.
- Flashes briefly while time is being set, then reverts to displaying the set temperature.
- Turns off when no timer is active.

#### Defrosting / Preheat Light (Defrost)

- Lights up during defrost, oil return, or cold-air prevention modes.
- Turns off when these modes are inactive.
- Note: For some unit types, oil return may not be displayed. (e.g. one-to-one systems).

#### Warning Light (Fault)

- Lights up when a system error occurs (e.g. codes starting with E\* or P\*).
- Running light turns off during fault indication.

#### Digital Display

- Shows set temperature during normal operation.
- Temporarily flashes during timer setup.
- Displays error code if a fault occurs.

#### Manual Switch

- Allows manual control of the unit's power if the remote is unavailable.

# Appendix

# A

## For Systems with Additional Leakage Sensor - If Applicable

### Important Notes:

- Use the sensor only in certain specific installation scenarios that may call for an auxiliary refrigerant leak sensor to be installed. All indoor units possess leak sensing abilities, while only some installations require a separate sensor. Qualified personnel must maintain the refrigerant sensor. Only use sensors specified by the manufacturer as replacements.
- The refrigerant sensor has a design life of 15 years. Replace the sensor within its service life.
- The sensor automatically monitors the system operation. If refrigerant concentration exceeds the alarm threshold, the system will stop the compressor and start the circulation fan for safety.
- The alarm indicators for the refrigerant sensor are shown below:

Condition	Error Code
Refrigerant Leak Detected	Display "Hd"
Communication Error with Refrigerant Sensor	Display "Fd"

- The sensor's installation position is illustrated below. **Note:** The actual location may vary depending on the model and cabinet design.

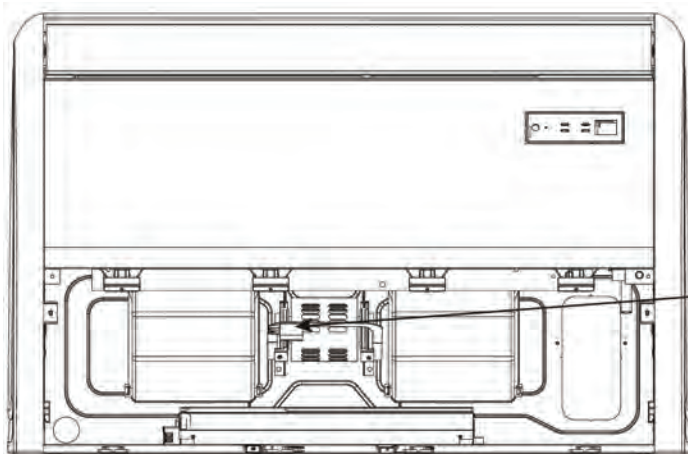

Position of refrigerant sensor for 18,000  
- 22,200 BTU size air handlers

- The unit is equipped with a refrigerant leak detector for safety. The unit must remain electrically powered at all times after installation, except during service.
- Only use manufacturer-approved sensors as replacements.



# Appendix

# A

## For Systems with a Wireless Internet Module - If Applicable

Instructions for getting your system connected to Pioneer® Airlink 

Search for "Pioneer Airlink" in the Google Play Store (for Android users) or the App Store (for iOS users). **Note:** A 2.4GHz Wi-Fi connection is needed to use the Wi-Fi control feature.



**Download Android App**



**Download iOS App**

Begin by ensuring the Internet module is securely plugged into the indoor air handler. Next download the app from the store and enter the setup phase in the app where it asks to reset the system. After doing so, complete the following:

1. Turn off the unit using the remote controller.
2. Turn off the circuit breaker that is powering the outside unit for 10 seconds. Then turn it back on.
3. Turn on the unit using the remote controller.
4. Press the "DISPLAY" button on the remote controller six times in a row within 6 seconds.
5. The indoor unit will flash "AP" (Access Point) or "CF" (Config) on the LED display.
6. The unit is ready to pair. Proceed through the prompts within the application.
7. The unit will be paired. Repeat these steps for any other units.

# Appendix

# A

## Product Disposal Guidelines

This appliance contains refrigerant and other potentially hazardous materials. When disposing the appliance, the law requires special collection and treatment. Do not dispose this product as household waste or unsorted municipal waste.

**Remove all refrigerant and oil prior to disposal as outlined within this manual.**

When disposing of this appliance, the following options are available:

- Dispose of the appliance at a designated municipal electronic waste collection facility.
- When buying a new appliance, the retailer will take back the old appliance free of charge.
- The manufacturer will take back the old appliance free of charge.
- Sell the appliance to certified scrap metal dealers.

## Special Notice

Disposing of this appliance improperly, or in other natural surroundings, endangers your health and is bad for the environment. Hazardous substances may leak into the ground water and enter the food chain. Follow proper disposal protocols.

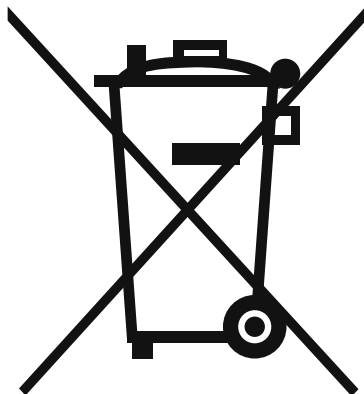

# Appendix



## If Refrigerant Has Been Added to the System During Installation

(For the Installer) fill in the following:

- 1) The factory refrigerant charge of the product (located on the outdoor unit nameplate).
- 2) The additional refrigerant charged into the product.
- 1+2) The total refrigerant charge.

① =

ozs (kg)

② =

ozs (kg)

---

① + ② =

ozs (kg)

We recommend keeping this information handy for future service and maintenance needs.

## System Notes

---



---



---



---



---



---

The design and specifications of this product are subject to change without prior notice as development continues. Consult with the sales agency or manufacturer for details. Refer to the equipment nameplate for all other applicable specifications.



is a registered trademark of Parker Davis HVAC International, LLC.

Parker Davis HVAC International  
7290 NW 77 Court, Miami, FL 33166 - USA  
Tel : (305) 513-4488  
Fax : (305) 513-4499  
E-mail : info@pdhvac.com  
Website: www.pdhvac.com

Pioneer product line, parts, and supplies are available online for convenient ordering at:  
[www.highseer.com](http://www.highseer.com)  
[www.pioneerminisplit.com](http://www.pioneerminisplit.com)

Scan the below code to visit our support page where you can find more installation materials:



Copyright 2025, Parker Davis HVAC International, LLC., All rights reserved.

---