

## CONTACT INFORMATION

We want to hear your voice! Feel free to touch base if you encounter any issue when using our product(s) or want to know more about our brand.

We will be more than happy to provide top-notch pre-sales & after-sales service 24/7.



## **Ceiling Fan** *Installation Instruction*



## WARNING

- Do not install the fan with wet hands.
- Do not insert foreign objects between the rotating fan blades.
- Do not bend the fan blades when installing or cleaning the fan.
- Do not disassemble or modify this product or use non-original parts without permission.
- Keep children away from your working area.
- Properly dispose of the fan's packaging material.
- Make sure the ceiling fan is firmly secure to the ceiling. Double check all connections before you restore power.
- Turn off the fan and wait for the blades to stop completely before performing any maintenance or cleaning.

## PRE-INSTALLATION

### Tools Required (Not Included)



Power Drill

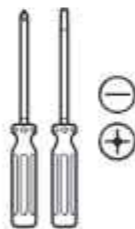

Screwdriver



Step Ladder



Wire Stripper

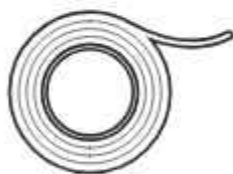

Electrical Tape

## SAFETY INFORMATION



## WARNING

- High voltage danger, do not disassemble the motor and controller for non-professional maintenance personnel, please do not turn on the power. Do not touch the Led strip and light source.
- This machine contains uninsulated "high voltage", avoid electric shock, non-professional maintenance personnel do not modify without authorization. If you need to repair, please entrust qualified maintenance personnel to carry out.

### Pay attention to safety matters before installation

Fans must be installed by professionally qualified personnel and must not be installed by the user.

1. Fan installation, disassembly and installation before, please cut off the power supply, installation must be installed in the order of ground, zero, fire wire. Dismantling must be done in the order of fire, zero and ground to avoid electric shock.
2. When installing the fan, first make sure the mounting surface can with stand 4 times the weight of the fan, and the screws of each part must be locked firmly.
3. When the fan is rotating, do not touch the blades with your hands or any other objects to avoid danger.



7.6 feet (2.3 m)  
fan blades above the floor

## Function Introduction

1. The fan and the lamp are perfectly combined with the function of lighting and fan.
2. Different styles with dimming, speed control, timing, voice control, remote control and other functions, see the details of the corresponding products purchased online Function parameters.
3. Inverter models with forward and reverse function, forward to send air down, reverse to suck air up to make the air flow fresh.

## Parts List



hanging saucer X1

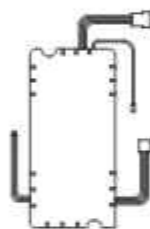

Receiver X1



Remote Control X1

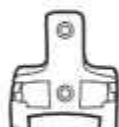

Remote Control Bracket X1



Umbrella head screws X4

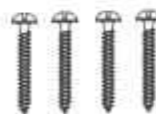

Wooden screws X4



Gasket X4



Plastic shell X4

## REMOTE CONTROL FUNCTION INTRODUCTION

### Remote Control



- Light ON/OFF** Only the light source is controlled on and off.
- ALL OFF** Lights and fans all off.
- FAN/OFF** After the power is turned on, press and hold this code key within 5 seconds, and hear a ticking sound, indicating successful code matching.
- F** **Forward:** Summer fan positive rotation, enhanced cold air flow, strong wind.
- R** **Reversal:** The fan reverses in winter, it reduces the temperature difference between cold and warm, circulates the warm air.
- ☪** Natural wind mode, more uniform wind speed, comfortable.
- 1H** The fan will automatically shut off after 1 hour.
- 2H** The fan will automatically shut off after 2 hours.
- 4H** The fan will automatically shut off after 4 hours.

## HANGER PLATE INSTALLATION

### Step 1: Take The Hanging Plate

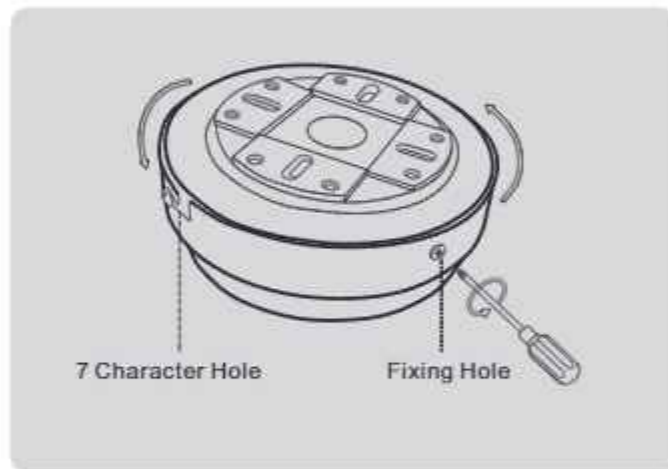

1. With a Phillips screwdriver, twist in a counterclockwise direction to remove the two screws in the fixed hole and loosen the two screws in the 7-hole.

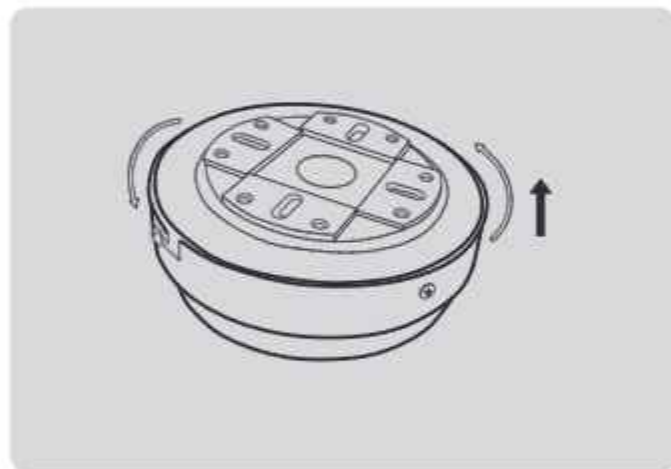

2. Gently rotate counterclockwise to remove the hanging disc.

## CEILING INSTALLATION

### Step 2-1: Concrete ceiling installation

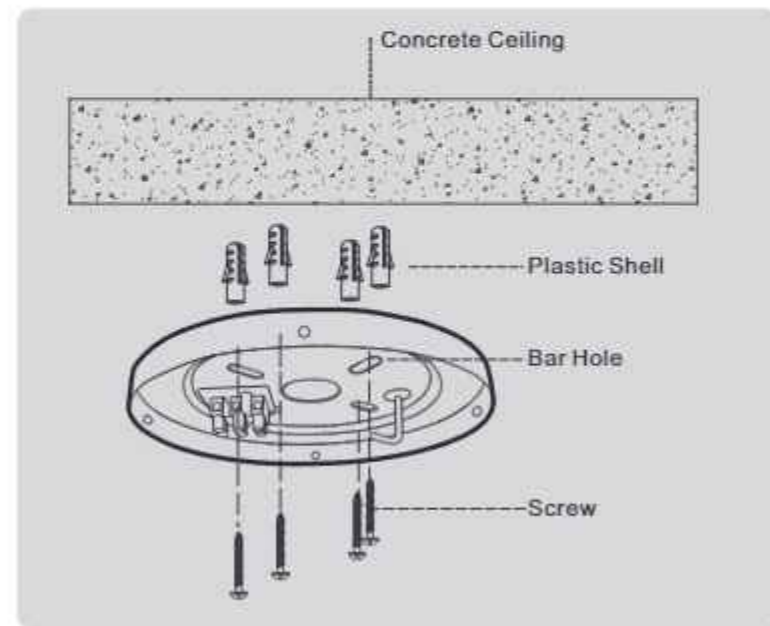
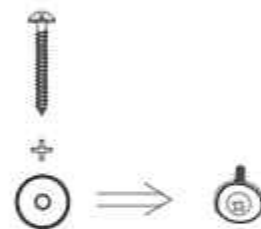

Figure a



1. Four 6mm holes in the concrete ceiling with an impact drill, corresponding to the holes of the hanging plate strips.
2. Take out the parts package and remove the rubber case.
3. Put the spacer of the parts package, into the screw, as shown in Figure a.
4. Align the hanging disc strip hole with the 6mm hole, smash the rubber shell into the concrete ceiling, fix the hanging disc and then lock the screws completely inside the rubber shell, as shown in Figure b.

## HANGER PLATE INSTALLATION

### Step 2-2: Wooden ceiling installation

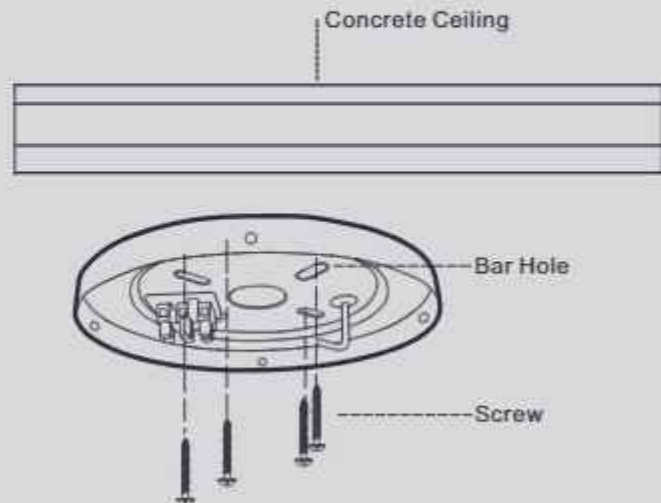
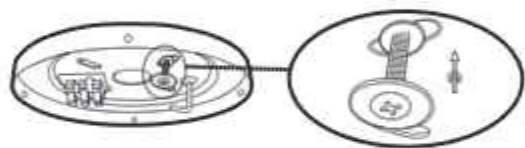

Figure b



1. Take out the screw package, take out the gasket and put it on the screw, as shown in Figure a
2. Use an electric screwdriver to align the screws with the tray strip holes and lock the tray on the wooden ceiling (note: the thickness of the wooden ceiling must be greater than 1.2cm)

## FAN INSTALLATION

### Step 3: Wiring Installation

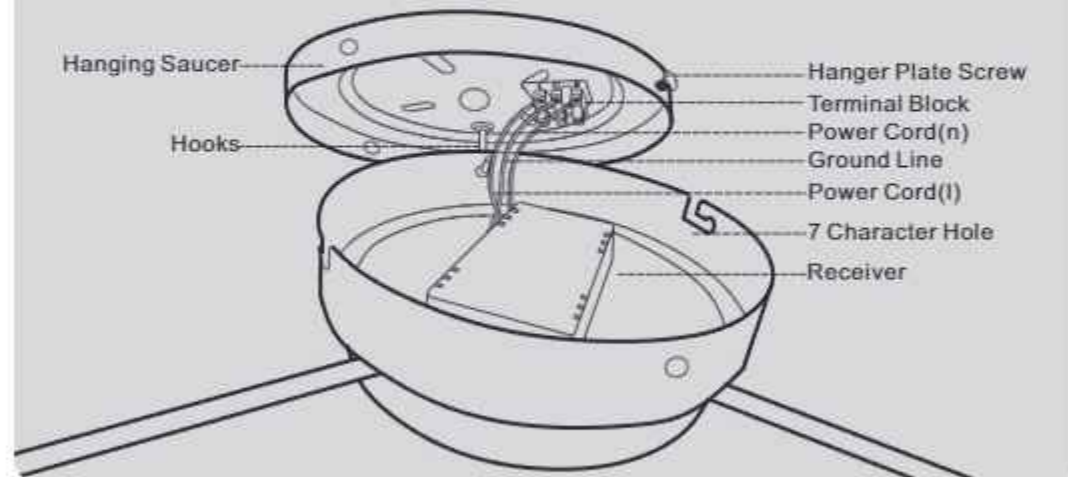

1. Connect the fan light and the hanging plate by hooks.
2. Insert the controller power cable (L, N) and ground cable into the corresponding holes of the terminal block and lock them tightly.

#### Step 4:Lamp Body Installation

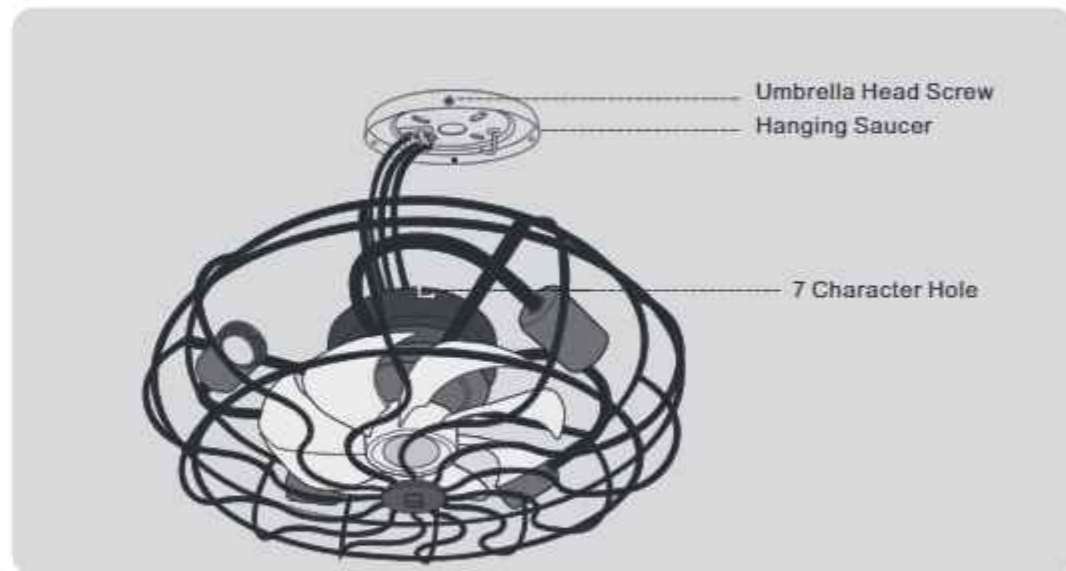

- 1.After connecting the wires, remove the fan light from the hook, align the 7-hole with the umbrella head screw, install it upward and rotate clockwise so that the umbrella head screw is stuck at the end of the 7-hole, and lock it.
- 2.The remaining two umbrella head screws will be installed on the lock, the fan light installation is complete.

#### PRODUCT PARAMETERS



Product Name	Ceiling Fan	Product Model	DY-2602
Rated Voltage	110V-265V	Gross Weight	9.2LB
Motor Power	21W $\pm$ 10%	Net Weight	4.6LB
Control Method	Remote Control	Product Size	Diameter 48cm Height 18cm
Lamp Configuration	10W-200W	Input Current	170mA $\pm$ 10%

- Factory without bulbs, need to buy their own