

GeekSmart[®]

ROBOT VACUUM CLEANER

User Manual

Model No.: G6

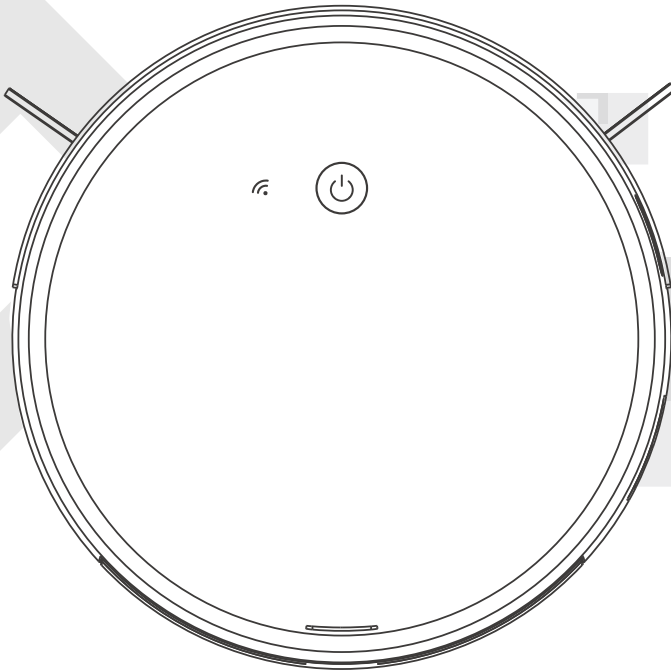

IMPORTANT: Read the instructions carefully before operating the appliance and keep them for future reference.

Safety Instructions	01
Product Components	03
How To Use	08
Cleaning And Maintenance	13
Troubleshooting	20

welcome

GeekSmart bids you welcome to a world of smart home devices, the robot vacuum cleaner. GeekSmart strives to explore and develop the smart home industry for the good of all by combining cutting-edge technologies to develop products fit and ready for the market. Please visit our website www.geektechnology.com.

Before use, please scan the QR codes to watch our easy step-by-step installation video. If you have questions regarding the installation process, please contact us by mail customercare@geektechnology.com or by phone **1-844-801-8880 / (862) 352-0406**.



Scan the QR code for more assistance and support

Important Safety Instructions

Please read the manual carefully before using the product and keep this instruction for reference.







1. Products cannot be used by children under 8 years of age or people with mental disabilities. If these kinds of people need to use it, please do so under the supervision of the guardian. Please do not let children ride on the product or play with the product as a toy. Do not use the product in a room where infants sleep.
2. Issues that may arise in cleaning products should be eliminated as early as possible. Clean the power cords and small items on the floor to prevent the product from being blocked during the cleaning process. Fold the edge of the carpet to the underside of the carpet, and keep the hanging curtains, tablecloths, etc from touching the ground.
3. If there is a suspended environment such as a staircase, test the product first to see if it can detect the edge of the suspended area without falling. Protective barriers should be installed at the edge of the suspended area to prevent falling products. Make sure that the protective equipment does not cause personal injury.
4. Please follow the manual in the instructions to use the product. Use only accessories recommended or sold by the manufacturer.
5. Ensure that the power supply voltage meets the voltage indicated on the cradle.
6. Used only in indoor home environments. Do not use in outdoor, commercial or industrial locations.
7. Use only original rechargeable batteries and charging docks that are unique to the manufacturer. Do not use non-rechargeable batteries.
8. Ensure that dust boxes and filter materials are installed before using products.
9. Using the product in an environment with open flames or fragile items is prohibited.
10. It is forbidden to get human's hair, clothes, fingers or other body parts close to the opening and operating parts of the product.
11. Do not use the product on wet or watery ground.
12. It is forbidden to absorb any items such as follows:
 - stones, waste paper.
 - flammable materials such as toner for printers or copies.
 - cigarettes, matches, ash, or other items that may cause a fire.

13. Do not place any product that is burning at the suction outlet. Do not use products when suction is blocked. Please clean the dust, cotton wool, hair, etc. at the suction port to ensure smooth air circulation at the suction port. Use the power cord carefully to avoid damage. Do not use the power cord to drag or pull the product. Do not use the power cord as a handle. Do not clamp the power cord into the door seam. Do not pull the power cord at sharp corners and corners.
14. Do not use the product if the power cord, power outlet or charging stand are damaged. Do not use the product when it is not working properly due to dropping, damage, outdoor use or water ingress. To avoid injury, the product should be repaired by the manufacturer or its after-sales service.
15. Turn off the product switch before cleaning and maintaining the product.
16. Before discarding the product, remove the product from the charge stand, turn off the product power switch, and remove the battery. Even if the product has been severely damaged, it is forbidden to incinerate the product, or the product battery may cause an explosion. Please dispose of used batteries in accordance with local laws and regulations.
17. If you do not use the product for a long time, please turn off the product.

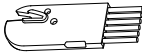

Immediately dispose of packaging as it can pose choking or other hazards to small children and pets. Please carefully confirm the consistency between the picture and the real components that correspond to the model you purchased.

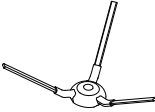
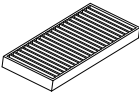
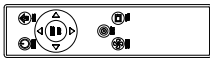
Product Components

What's in the Box	
	Robot Vacuum
	Charging Base
	Clean Brush
	Power Adapter
	Side Brushes X6
	HEPAX 2
	Remote Control (Optional)
	Instruction Manual

Robot

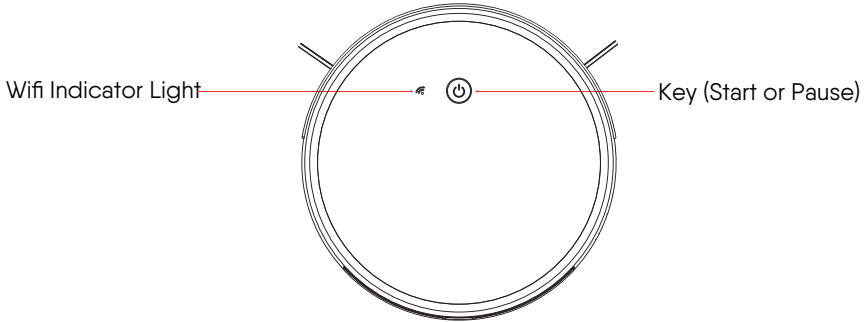

Top View

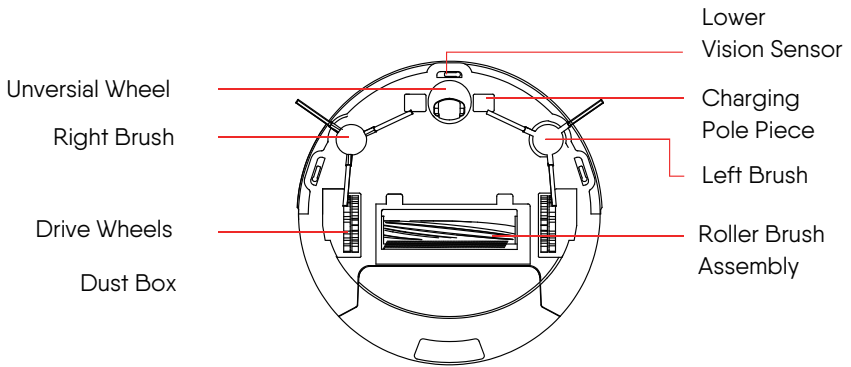

Bottom View

Dust Box

PRODUCT COMPONENTS

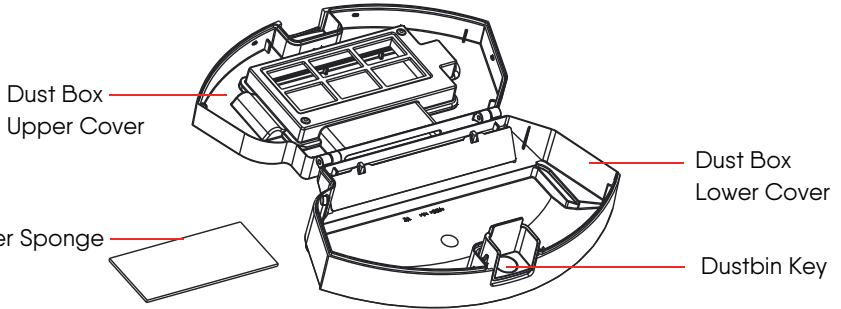
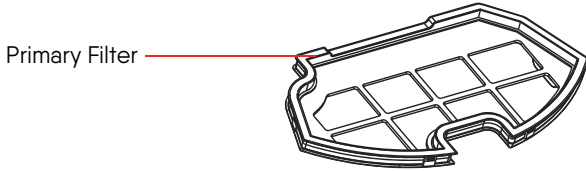
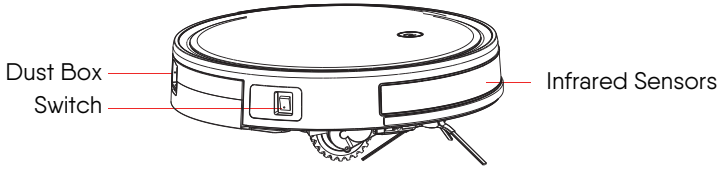

▶ Charging Base

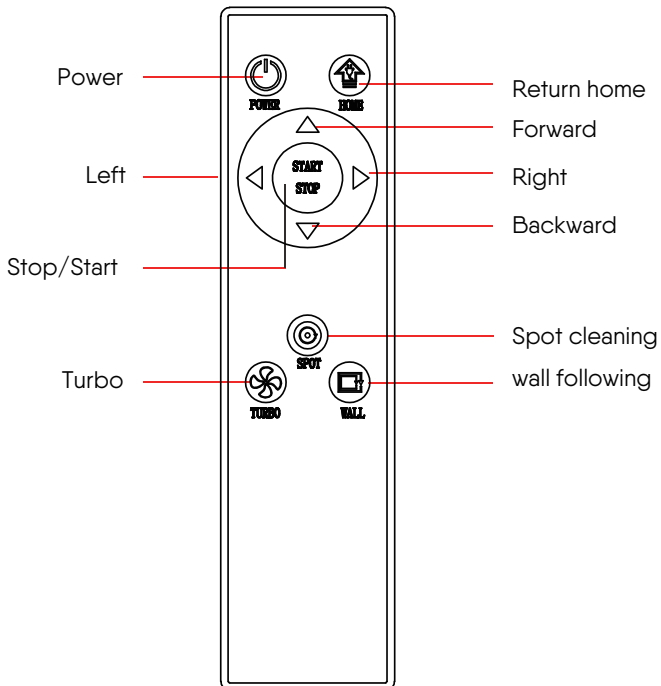
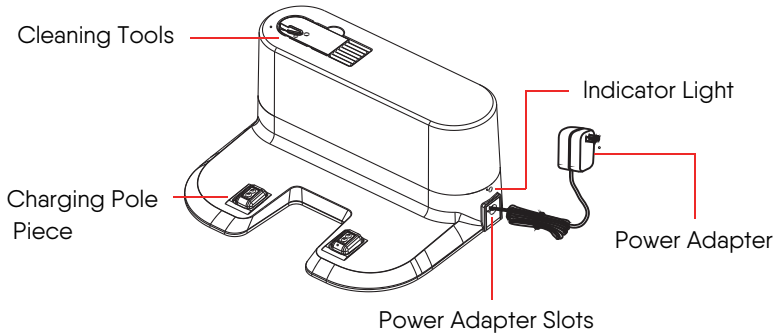

parameter

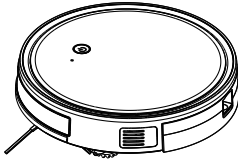
	Product Model	G6
	Input	100-240V/50-60Hz
	Power Consumption	30W
	Battery Capacity	Li-ion 2500mAh
	Dust Collector Capacity	0.6L
	Cleaning Time	Max.100 mins
	Charging Time	Round 300 mins

	Battery	DC 3V(AAA)
	Remote control method	Infrared
	Emitting and receiving distance	≤5M

	Input	100-240V/50-60Hz
	Output	19V/0.6A

Install 2AAA batteries before using the remote control for the first time. Make sure the positive and negative ends are facing the correct polarity direction as marked in the battery compartment.

How To Use

I ► Install The Side Brushes

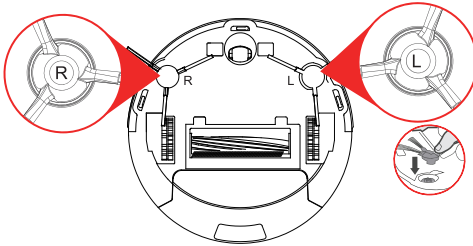

Please install the right brush into the right bottom mounting port of the machine, the left brush into the left bottom mounting port of the machine, and ensure that the two side brushes are in place.

I ► Charging Operation

1. Connect the adapter to the charging stand.

Place the charging stand flat against the wall. Do not place objects in the left and right '1M' and the front '2M' and do not have objects with strong reflection surfaces such as mirrors.

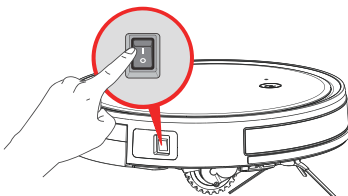
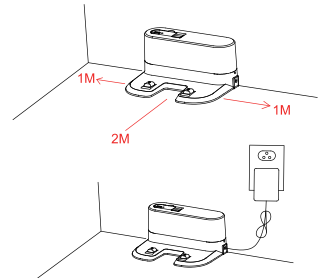

2. Turn On The robot

Turn on the side power switch, "1" is the turn-off. After the robot finishes working, it is recommended not to shut down; keep the robot in a state of charge so that it can perform its next job better.

3. Master Charge

Place the master in the charging stand and pay attention to the charging pole piece. Turn on the power switch, the robot will enter standby mode. “⏻” Red light flashes indicates that the battery need to be charged. “⏻” Blue light breathing light flashes indicate charging. When the “⏻” blue light is off means charging is completed. For the first use, please charge continuously for more than 6 hours. Note: Please match the charging pole piece.

Please match the charging pole piece

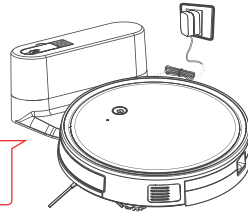

FAQ

Please install the right brush into the right bottom mounting port of the machine, the left brush into the left bottom mounting port of the machine, and ensure that the two side brushes are in place.

Q : What should I do if the strength of vacuuming is weak?

A : First of all, check whether the dust bin is full and the robot is fully charged. For litter that is difficult to collect, try to clean it with Spot Cleaning Mode.

Q:What if my charger has difficulties charging the robot?

A : Please make sure you turn on the charging stand before charging and check if the electrical sheet is connected to the charging stand(Put it back manually or press the Power button when the robot is 39.37 inch in front of the charging stand.)

Q : What if the robot can not find the charging stand?

A : The charging stand should be placed against the wall with at least 39.37 inch clearance each side and 78.74 inch in front .Sometimes you can just put it back manually.

Q: What should I do if the remote control is out of order?

- A: 1. The remote control has an effective control distance of 196.85 inch.
Please make sure that the remote point to the robot .
2. Replace the battery with a new one if the battery has run out of capacity.
 3. Please make sure the robot power switch is turned on and has sufficient power to complete the operation.
 4. Please wipe the infrared emitter of the remote control and the infrared receiver of the robot with clean towel.

Q: How long can the vacuum work when full charged?

A: The working time of the robot varies depending on the complexity of the room, the amount of garbage and the cleaning mode.

WiFi Connection

1. Please scan the QR code or search “GeekSmart” and download APP. After the APP is installed . Please follow the APP instruction to register the account and login.

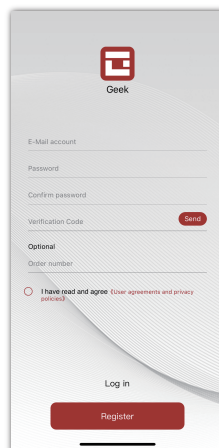

2. Open the APP, click **【add device】** or click the button **【+】** and select the “Robot Vacuum”, then click the model you bought.

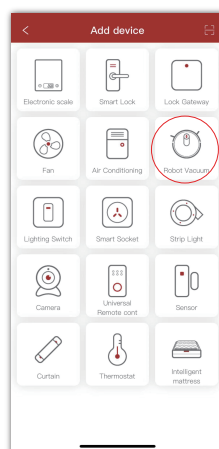
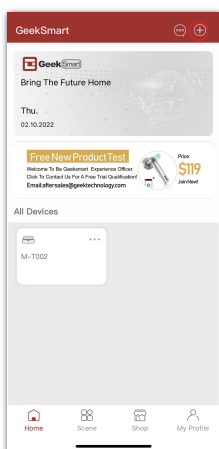

3. Please make sure that the product is on (like the picture shows)

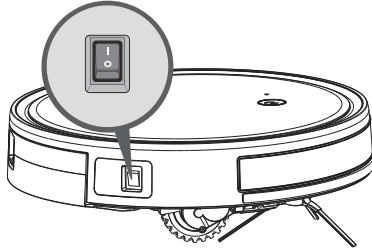

4. Long press “⏻” for 3 seconds, and then “📶” flashes, input the wi-fi account and password.(only support 2.4Ghz wifi,5Ghz can not be connected.) A few seconds later ,the product will be connected to your phone.

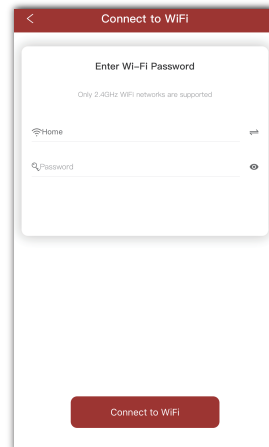
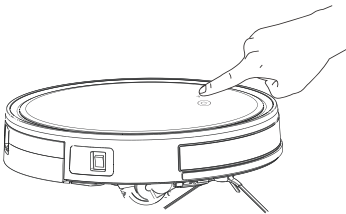

Cleaning And Maintenance

Please refer to the following guidelines to check the cleaning area before the cleaner works.

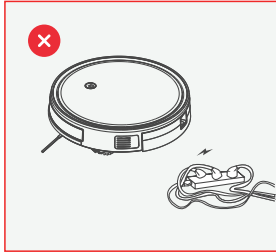

1. Power lines and other debris scattered on the ground may trip up the product, they must be removed.

2. Please roll the carpet tassels or let the product work on short-hair rugs.

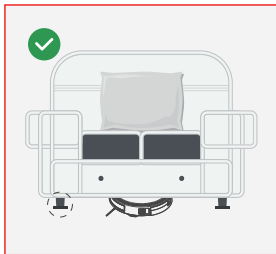
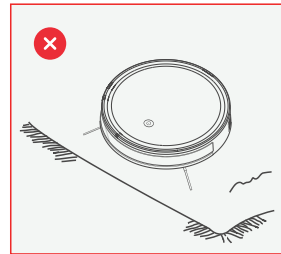

3. A gap of less than 3.2inch on the bottom of the furniture may catch the product. If you need to clean it, please remove the furniture.

4. A guardrail should be placed at the edge of the duplex to ensure safe operation of the product.

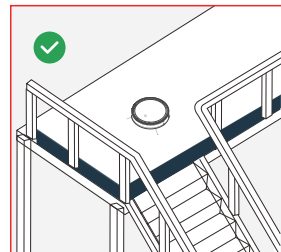

I ▶ Start/Stop Cleaning

1. Start or stop by pressing the master's "⏻" key or the remote control's "⏻" / "⏻" key.

NOTE: Before starting the mode, make sure that the outer ring of the "⏻" key is blue and the master is in the state of being awakened. If the master does not wake up, short press the master "⏻" to wake it up. The master enters the sleep state after 10 minutes of standby, and the "⏻" key light is off.

2. If you need to select another mode, please refer to the (Mode Selection) section.

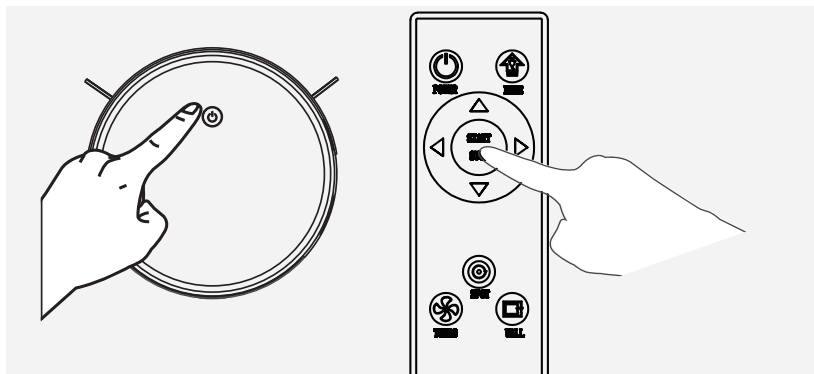

I ▶ Mode Selection

In order to adapt to different ground conditions and achieve deep cleaning, this product has a variety of cleaning modes, which can be selected by remote control as needed.

The remote control can switch any mode directly.

Before starting the mode, make sure that the "⏻" outer ring of the key is blue and the master "⏻" is in the state of being awakened. If the master does not wake up, short press the master to wake it up.

I ► Fixed-point Mode

It is suitable for the ground environment where the garbage is concentrated. The master centralized cleaning in the designated area, and master centralized cleaning with the “spiral” route.

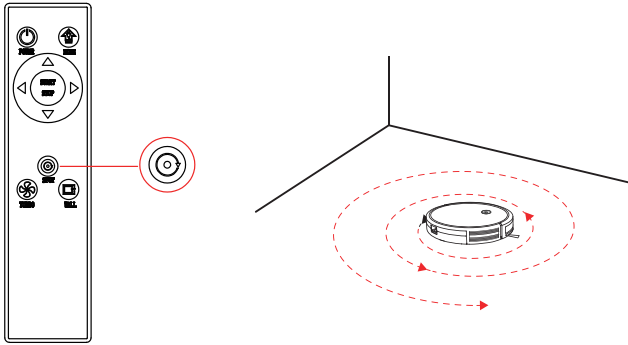

I ► Edge Mode

It is suitable for cleaning at the corners of the room. The master is cleaned around the periphery of a fixed object (such as a wall) and cleaned back to the charging stand.

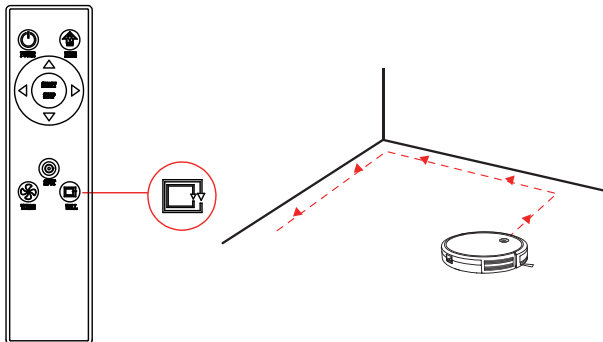

I ► Return Charging Mode

During the cleaning process, the master can sense that its power is insufficient, and automatically find the charging stand for charging.

You can press the “home” button or press the “power” button twice to make the master return to the charging stand for charging.

NOTE: In the regular cleaning mode, the maximum run time of the master could be 100 minutes while it would automatically return charging for next task if it has completed present one.

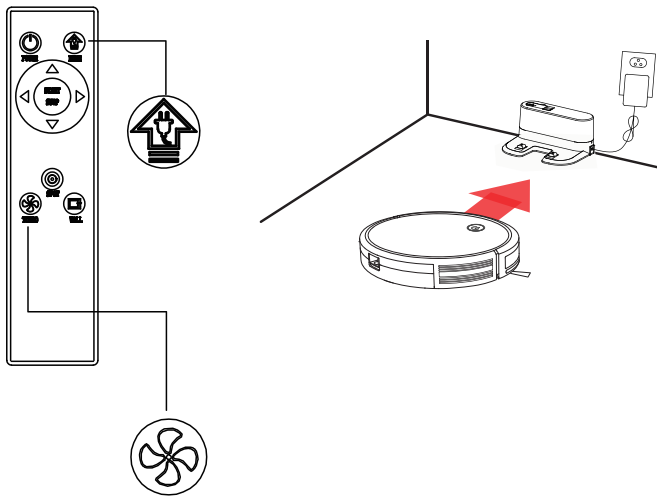

I ► Suction Power Setting

Press the “Turbo” button on the remote control.

With three modes of suction power (Max/Standard/Low), Standard mode can be used for daily cleaning while the Max mode would increase the suction and Low mode would lower the noise. Low suction mode can be used for cleaning wood floor and tile floor, standard mode for common household cleaning while the max mode can be used for cleaning rugs.

I ▶ Roller Brush Assembly and Cleaning

Remove the roller brush brush cover plate, remove the roller brush, cut of the hair wound on it and then use the cleaning brush to clean it.

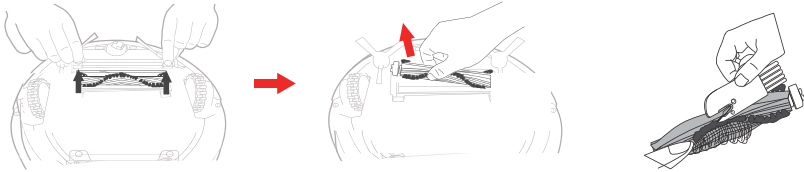

Set roller brush assembly: take out sucking assembly first, set the roller brush, cover the board and press it to lock.

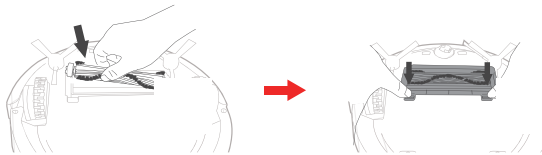

I ▶ Dust Box and Filter

When cleaning and maintaining the master and its accessories, turn off the master and unplug the charging stand.

1. Remove the dust box, open the dust box cover, and clean the garbage.
2. Remove dust filter. HEPA is not recommended for washing. Please pat and remove ash.
3. Flush the dust box and the primary filter.
4. Dry the dust box and the dust filter assembly and keep it dry to ensure its service life.

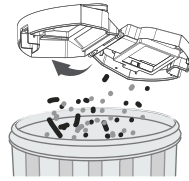
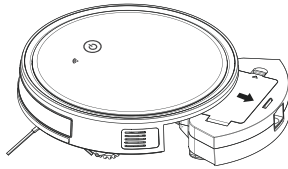
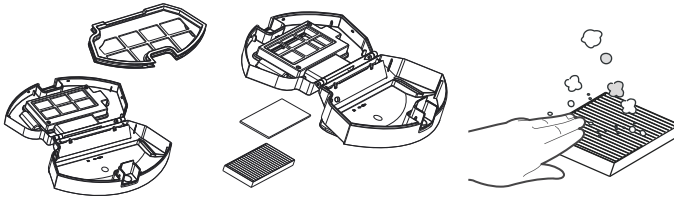
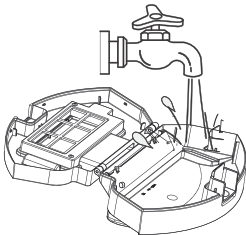
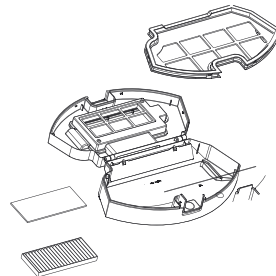
STEP
01STEP
02STEP
03STEP
04

Please let these parts dry naturally for more than 24 hours.

I ▶ Side Brushes

Cleaning Side Brushes

Pull out the side brush and wipe it with a clean rag.

I ▶ Other Assembly

Cleaning the universal wheel to reduce hair entangle.

Clear down the sensor to ensure the sensitivity of the sensor.

To clean the charging pole pieces, use a dry rag to clean the charging poles on the bottom of the master or the charging stand.

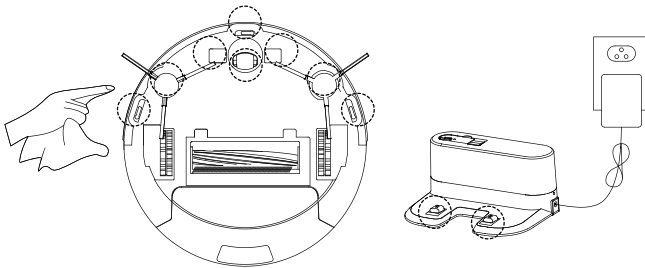

If you will not use the product for a long time, please remove the battery and keep it in a safe place. If the battery leaks, remove the battery and wipe the battery compartment clean.

This product uses a high-life battery and does not require frequent replacement. If you need to replace, you can contact our company for after-sales service replacement.

Troubleshooting

Cause of Issue	Display light	APPcontent	Solution
Side brush	Red light on	Please check side brushes are jammed	Clean side brush
Fan abnormality	Red light on	Motor cooling error	Please wait an hour before using
Roller brush	Red light on	Please check roller brush is jammed	Clean roller brush
No dustbin inside	Red light on	Please check if dustbin is installed correctly	Please check whether dustbin put in position
Failure of ground detection	Red light flush	Please check if wheels are on the floor	Clean the ground detector and make sure I am not picked
Out of trouble	Red light flush	Please help me, I'm stuck	Please take me to the open space
Low battery	Red light flush	Battery low, please recharge me	Manually move the cleaner back to the dock station recharging
Abnormality-charging	Red light flush	Please turn on the power switch for charging	Please turn on the power switch for charging
Gyro-scope fail	Red light flush	Navigation failure, please restart me	Turn on the switch again



GeekSmart®

Bring The Future Home

Geek Technology Ltd.
1275 Bloomfield Ave
Fairfield, NJ07004
Toll Free 1-844-801-8880 /
(862) 352-0406
www.geektechnology.com