





Hardware component L has been pre-assembled in component 8.

A	x 36
	
M6x25mm	

B	x 4
	
M4x25mm	

C	x 4
	
Φ15xM6x15mm	

D	x 4
	
Φ10xΦ5x1.0mm	

E	x 4
	
Φ20xΦ11xM4mm	

F	x 1
	
M4mm	

G	x 2
	
73x25x16mm	

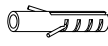
H	x 2
	
Φ6x30mm	

I	x 2
	
M6x12mm	



J	x 2
	
Φ4x30mm	

K	x 4
	
Φ10x1.0mm	

L	x 16
	

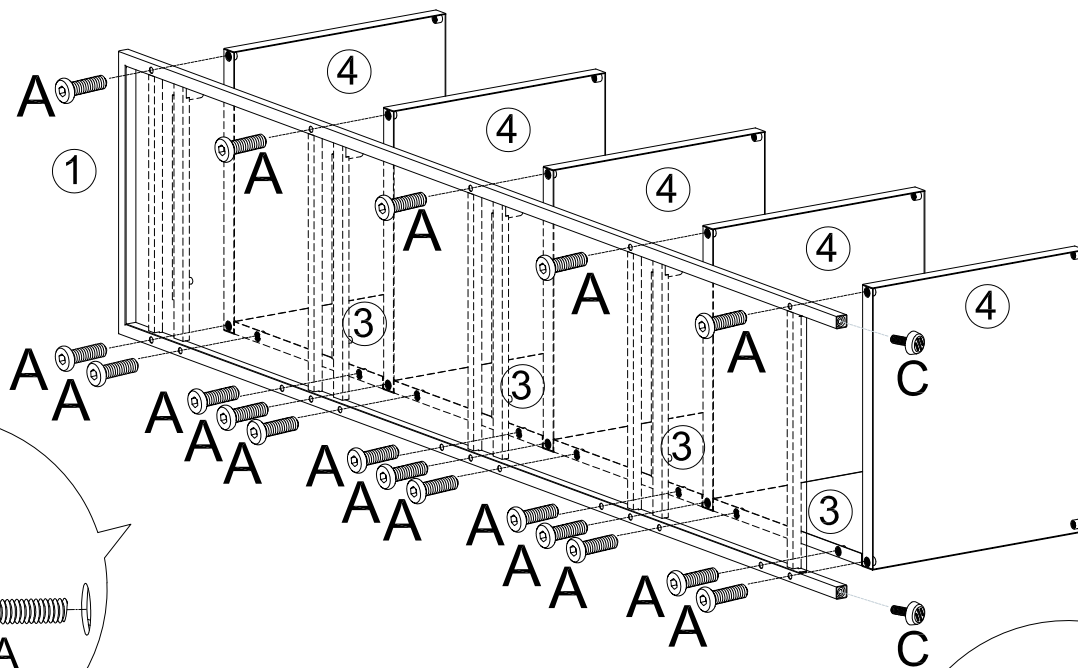

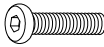
1

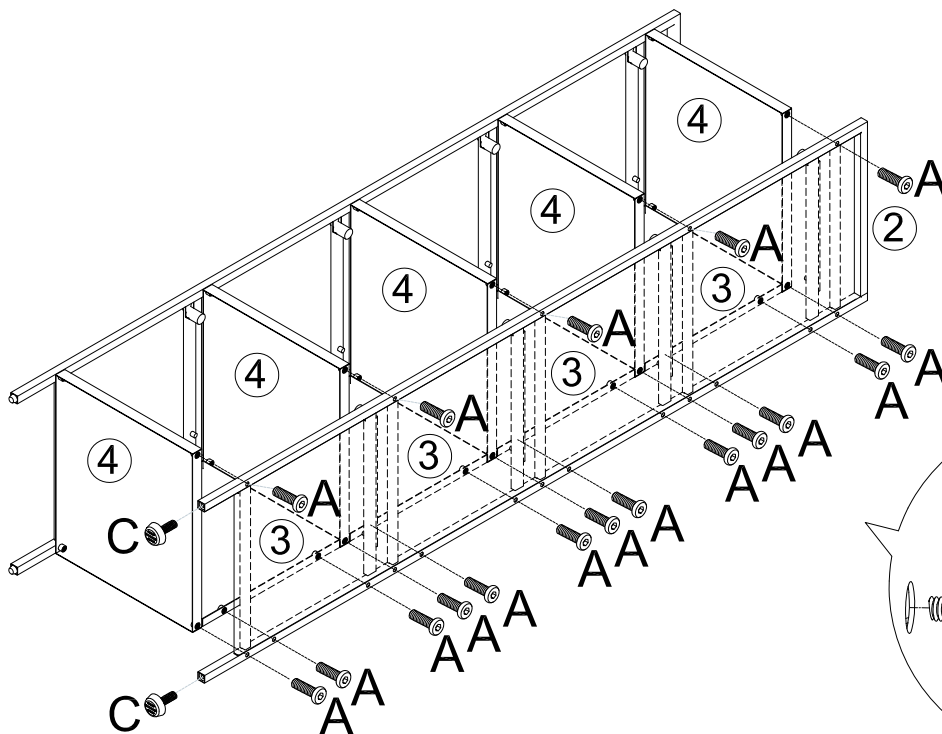

A	x 18	C	x 2
			
M6x25mm		Φ15xM6x15mm	

2

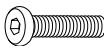

A	x 18	C	x 2
			
M6x25mm		Φ15xM6x15mm	

3

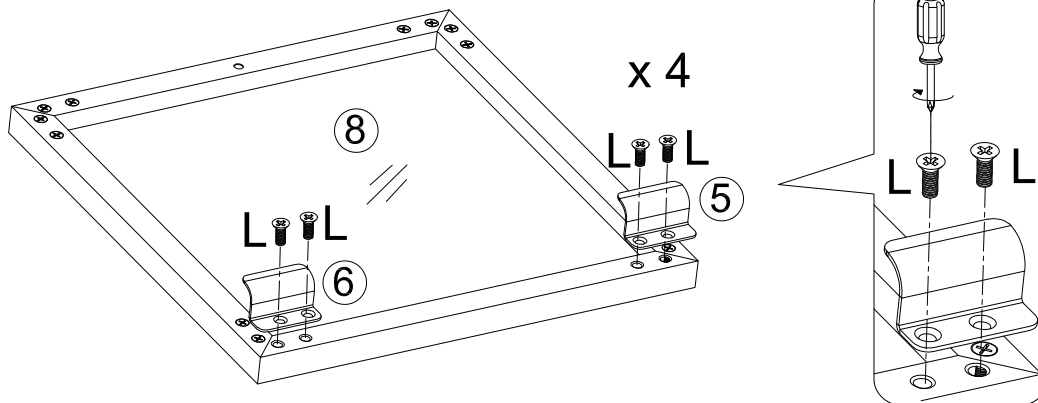
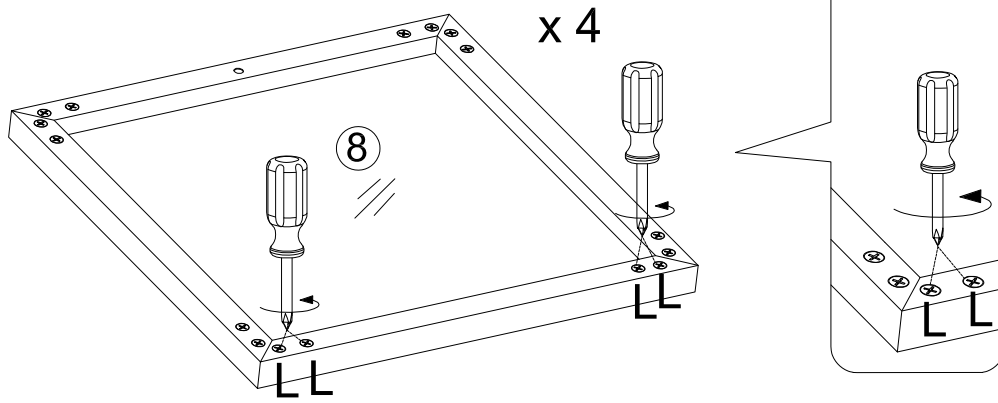

4

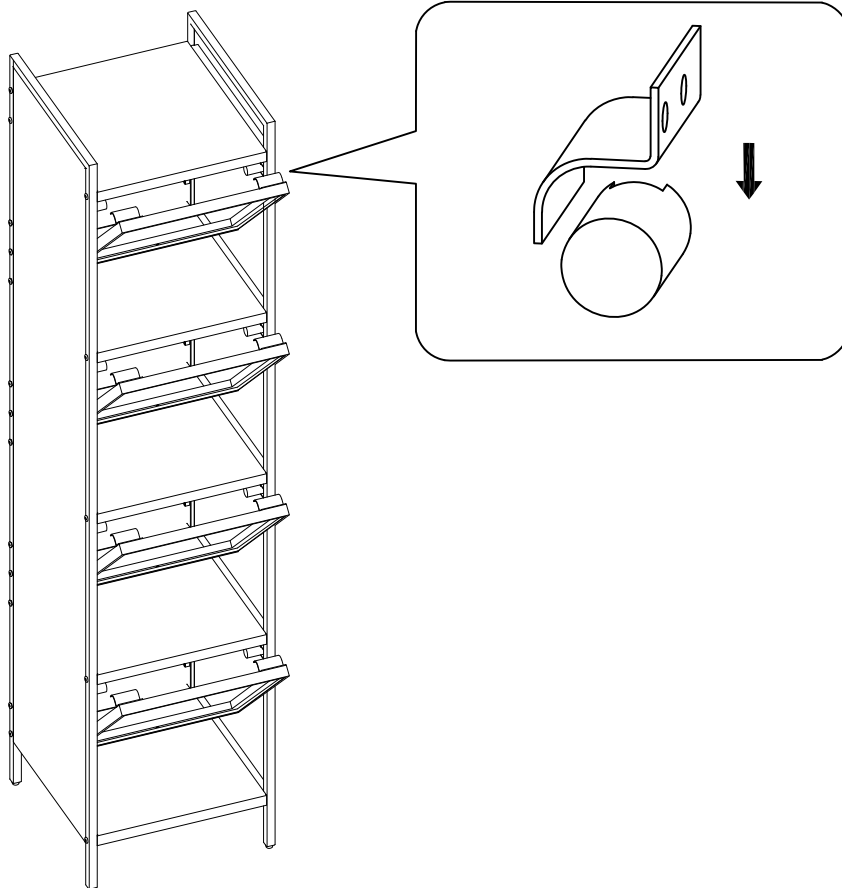

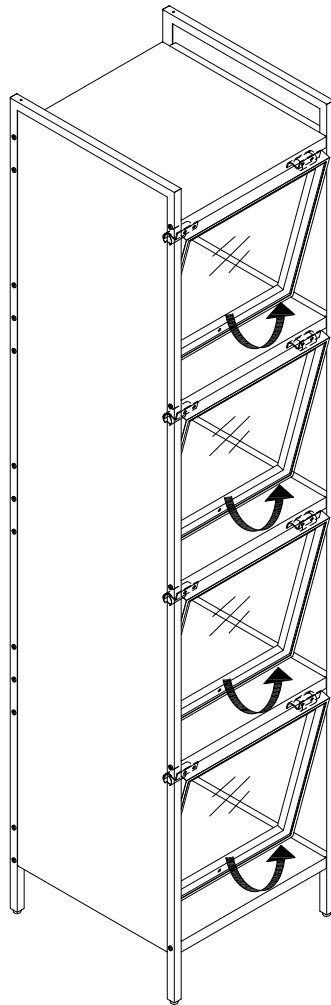

5



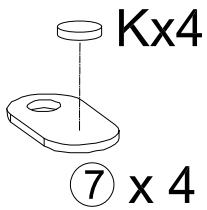
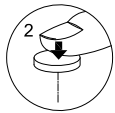

6



B	x 4
	
M4x25mm	

D	x 4
	
Φ10xΦ5x1.0mm	

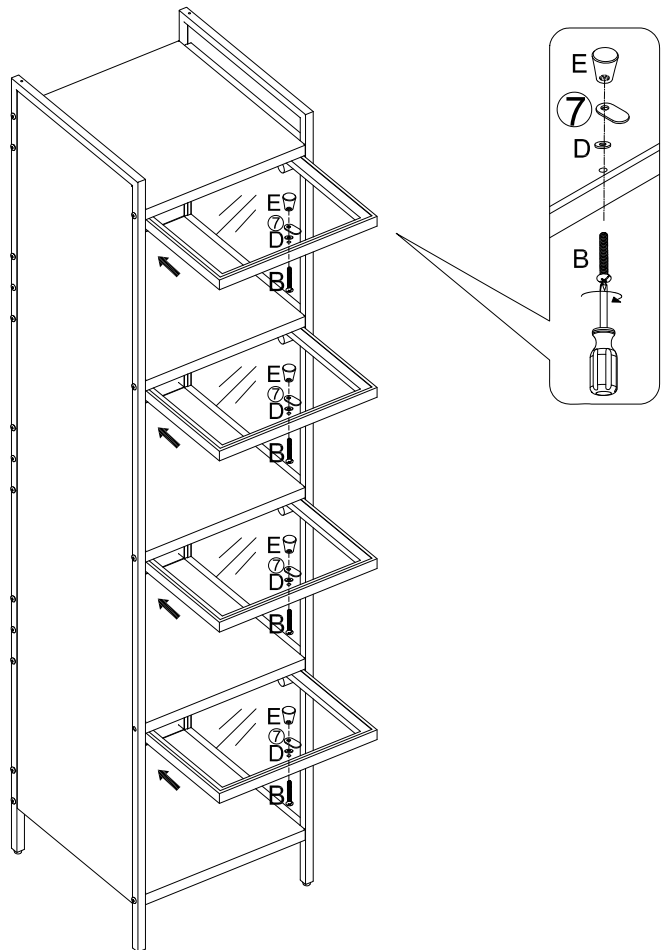

E	x 4
	
Φ20xΦ11xM4mm	

K	x 4
	
Φ10x1.0mm	



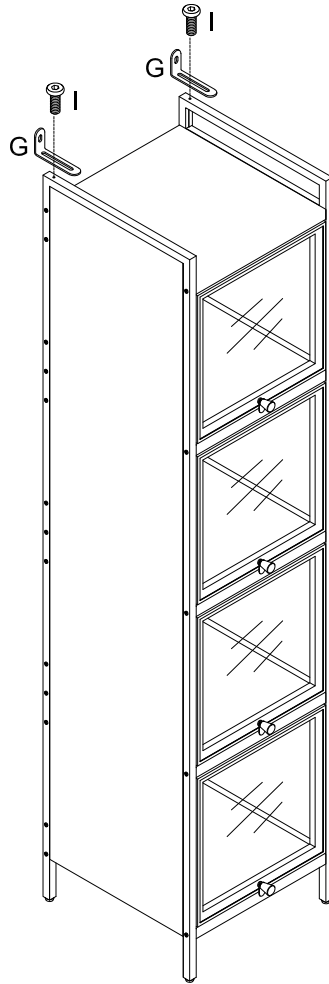

7

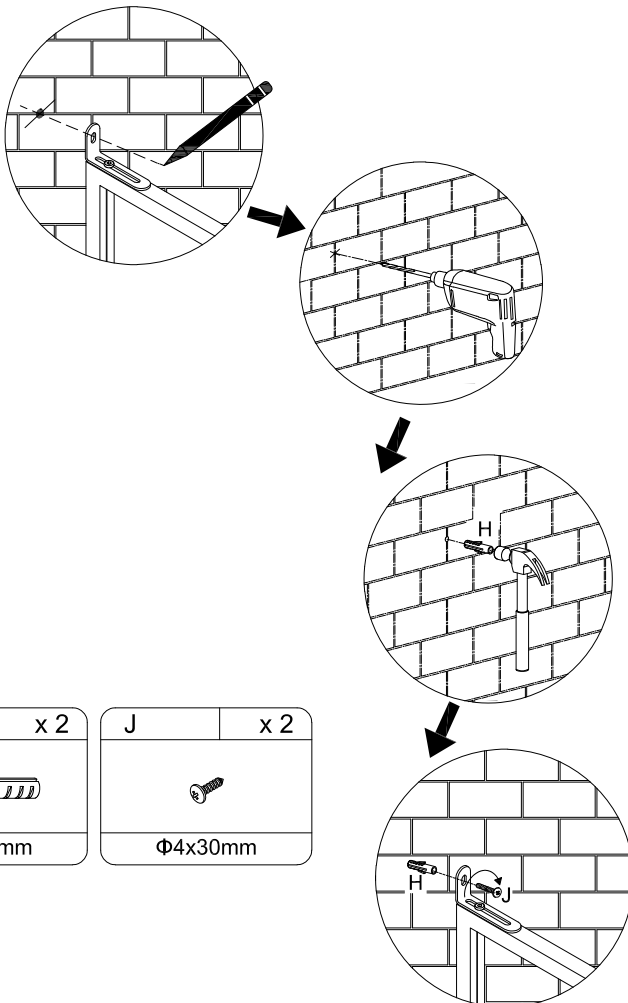

G	x 2	I	x 2
			
73x25x16mm		M6x12mm	

8

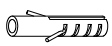

H	x 2	J	x 2
			
Φ6x30mm		Φ4x30mm	

